

# Control Devices

Control device for panel mounting

Ex e

8003/111-015S Art. No. 269838



- Flexible configuration due to pushbutton, mushroom push-button, mushroom stay-put button, mushroom stay-put button with key lock, key-operated button, key-operated switch
- Easy assembly thanks to single-hole mounting
- Codable "latching", "spring return", "key not removable" functions
- Spring clamp terminals with connection chamber

MY R. STAHL 8003B



The switches and control buttons for R. STAHL series 8003 panel mounting devices have various switching functions in latching and spring return versions, which can be subsequently recoded, up to 6 A. They are completely certified, explosion-protected equipment with Ex e connection chambers. With the patented mounting mechanism, panel mounting with normal drilled holes of 30.5 mm is quick and easy.

The right actuators are available for a comprehensive range of applications.

## Technical Data

### Explosion Protection

Scope of validity	European Union (ATEX) IECEX CCC
Application range (zones)	1 2 21 22
IECEX gas certificate	IECEX PTB 06.0065X
IECEX gas explosion protection	Ex db eb IIC T6 Gb
IECEX dust certificate	IECEX PTB 06.0065X
IECEX dust explosion protection	Ex tb IIIC T80 °C Db
ATEX gas certificate	PTB 02 ATEX 1057 X
ATEX gas explosion protection	⊕ II 2 G Ex db eb IIC T6 Gb
ATEX dust certificate	PTB 02 ATEX 1057 X
ATEX dust explosion protection	⊕ II 2 D Ex tb IIIC T80 °C Db
Certificates	ATEX (PTB), IECEX (PTB), Korea (KGS)
Declaration of Conformity	ATEX (EUK), China (CCC), Declaration of Conformity (ATEX)
Notes	Product label may vary. Series devices have certification according to ATEX and IECEX.

### Electrical Data

Rated operational voltage AC	500 V
Rated operational current	6 A
Switching capacity AC-12	500 V / 6 A / max. 3000 VA
Switching capacity AC-15	400 V / 6 A / max. 1250 VA
Switching capacity DC-13	110 V / 1 A / max. 110 W
Switching capacity DC-13<SoftReturn/>2 contact elements in series	60 V/6 A

# Control Devices

Control device for panel mounting

Ex e

8003/111-015S Art. No. 269838



## Ambient Conditions

Ambient temperature	-55 °C ... +60 °C
Ambient temperature	-67 °F ... +140 °F

## Mechanical Data

Degree of protection (IP) (IEC 60529)	Reverse side IP65, front side IP66
Enclosure material	Polyamide
Contact material	Silver-nickel
Silicone-free	No
Number of NCs	1
Number of NOs	1
Connection cross-section	0.75 ... 1.5 mm <sup>2</sup>
Connection cross-section AWG	18 AWG ... 12 AWG
Depth of cut-out	130 mm
Mounting depth, inches	5.12 in
Service life, min.	10 <sup>5</sup> operating cycles
Weight	145 g
Weight	0.32 lb

## Mounting / Installation

Tightening torque	3 Nm
Tightening torque lbf in	26.55 lbf in

## Components

Actuator	Mushroom stay-put button EM-STOP, 55 mm
Entry 1	8161/7-M16-0902
Entry 1 type	Polyamide cable gland, black

## Technical Drawings – Subject to Alterations

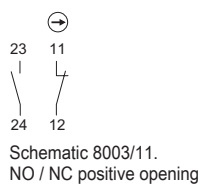

## Dimensional Drawings (All Dimensions in mm [inches]) – Subject to Alterations

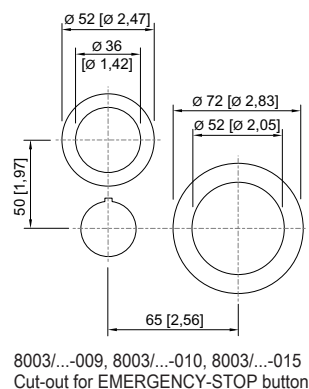
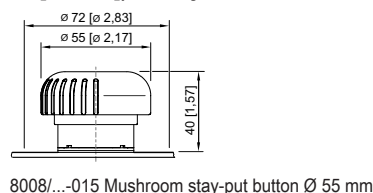
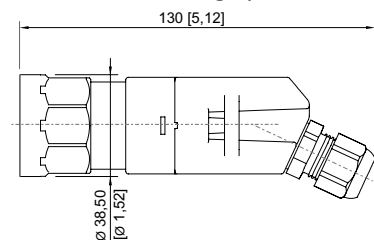

# Control Devices

Control device for panel mounting

Ex e

8003/111-015S Art. No. 269838

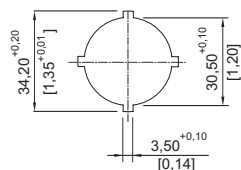

Cut-out details

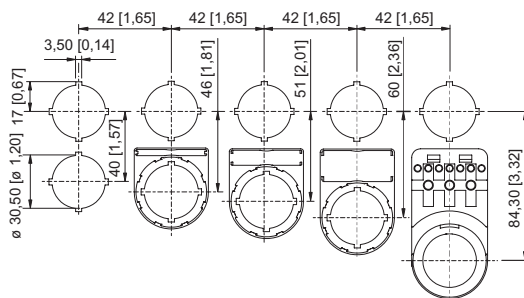

Cut-out with/without additional designation plate

## Accessories

### Actuators

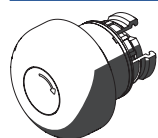

Mushroom stay-put button EM-STOP, dia. 55

Art. No.

261757

### Spare Parts

#### Label, yellow, general



for Ø 55 actuator (EM-STOP)

Art. No.

223572

#### Symbol label for pushbutton and selector switch



Colour: red  
Symbol: Arrow

Art. No.

155567

#### Closing part



8602C3-733-B  
for closing unused holes in cover, dia. 30.5 mm, NBR

8602C3-733-S  
for closing unused holes in cover, dia. 30.5 mm, silicone

Art. No.

244306

244307

We reserve the right to make alterations to the technical data, dimensions, weights, designs and products available without notice. The illustrations cannot be considered binding.