



Audio signalling device

Series YA60/2

Contents

1	General information	3
1.1	Manufacturer	3
1.2	Information regarding the operating instructions	3
1.3	Further documents	3
1.4	Conformity with standards and regulations	3
2	Explanation of symbols	4
2.1	Symbols used in these operating instructions	4
2.2	Warning notes	4
2.3	Symbols on the device	5
3	Safety notes	6
3.1	Operating instructions storage	6
3.2	Personnel qualification	6
3.3	Safe use	6
3.4	Modifications and alterations	7
4	Function and device design	7
4.1	Function	7
4.2	Device design	8
5	Technical data	9
6	Transport and storage	12
7	Mounting and installation	12
7.1	Dimensions/fastening dimensions	12
7.2	Mounting/dismounting, operating position	13
7.3	Installation	14
8	Commissioning	27
8.1	Prerequisites	27
8.2	Testing	27
9	Operation	28
9.1	Troubleshooting	28
10	Maintenance, overhaul, repair	28
10.1	Maintenance and overhaul	28
10.2	Repair	28
10.3	Returning the device	29
11	Cleaning	29
12	Disposal	29
13	Accessories and spare parts	29

1 General information

1.1 Manufacturer

R. STAHL Schaltgeräte GmbH
Business Unit Lighting & Signalling
Nordstr. 10
99427 Weimar
Germany

Tel.: +49 3643 4324
Fax: +49 3643 4221-76
Internet: r-stahl.com
E-mail: info@r-stahl.com

R. STAHL Schaltgeräte GmbH

Am Bahnhof 30
74638 Waldenburg
Germany

Tel.: +49 7942 943-0
Fax: +49 7942 943-4333
Internet: r-stahl.com
E-mail: info@r-stahl.com

1.2 Information regarding the operating instructions

ID no.: 276787 / YA6060300110
Publication code: 2023-11-09·BA00·III·en·04

The original instructions are the German edition.
They are legally binding in all legal affairs.

1.3 Further documents

- Data sheet

For documents in other languages, see r-stahl.com.

1.4 Conformity with standards and regulations

For certificates and declaration of conformity, see r-stahl.com.

2 Explanation of symbols

2.1 Symbols used in these operating instructions

Symbol	Meaning
	Tips and recommendations on the use of the device
	General danger
	Danger due to explosive atmosphere







2.2 Warning notes

Warning notes must be observed under all circumstances, in order to minimise the risk resulting from design engineering and operation. The warning notes have the following structure:

- Signalling word: DANGER, WARNING, CAUTION, NOTICE
- Type and source of danger/damage
- Consequences of hazard
- Taking countermeasures to avoid the danger or damage

	DANGER
	Danger to persons Non-compliance with the instruction results in severe or fatal injuries to persons.
	WARNING
	Danger to persons Non-compliance with the instruction can result in severe or fatal injuries to persons.
	CAUTION
	Danger to persons Non-compliance with the instruction can result in light injuries to persons.
NOTICE	
Avoiding material damage Non-compliance with these instructions can result in material damage to the device and/or its surroundings.	

2.3 Symbols on the device

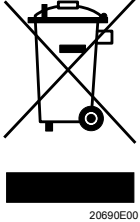
Symbol	Meaning
 0158 05594E00	CE marking according to the current applicable directive.
 8505 23486E00	UKCA marking according to the currently applicable directive.
 02198E00	Device certified for hazardous areas according to the marking.
 15649E00	Input
 15648E00	Output
 11048E00	Safety notes that must always be observed: The corresponding data and/or safety-related instructions contained in the operating instructions must be followed for devices with this symbol!
 20690E00	Marking according to WEEE directive 2012/19/EU

3 Safety notes

3.1 Operating instructions storage

- Carefully read the operating instructions.
- Store the operating instructions at the mounting location of the device.
- Observe applicable documents and operating instructions of the devices to be connected.

3.2 Personnel qualification

Qualified specialist personnel is required to perform the activities described in these operating instructions. This primarily applies to work in the following areas:

- Project engineering
- Mounting/dismounting the device
- (Electrical) Installation
- Commissioning
- Maintenance, repair, cleaning

Specialists who perform these activities must have a level of knowledge that meets applicable national standards and regulations.

Additional knowledge is required for any activity in hazardous areas!

R. STAHL recommends having a level of knowledge equal to that described in the following standards:

- IEC/EN 60079-14 (Project engineering, selection and construction of electrical systems)
- IEC/EN 60079-17 (Inspection and maintenance of electrical systems)
- IEC/EN 60079-19 (Equipment repair, overhaul and reclamation)

The wiring method conforms to:

- 1) In the USA, the NEC, NFPA 70 and the National Fire Alarm and Signaling Code, NFPA 72

3.3 Safe use

Before installation

- Read and observe the safety notes in these operating instructions!
- Ensure that the contents of these operating instructions are fully understood by the personnel in charge.
- Use the device in accordance with its intended and approved purpose only.
- Always consult R. STAHL Schaltgeräte GmbH if using the device under operating conditions which are not covered by the technical data.
- Make sure that the device is not damaged.
- We cannot be held liable for damage to the device caused by incorrect or unauthorised use or non-compliance with these operating instructions.



For mounting and installation

- Have mounting and installation performed only by qualified and authorised persons (see chapter "Personnel qualification").
- The device is only to be installed in areas for which it is suited based on its marking.
- During installation and operation, observe the information (characteristic values and rated operating conditions) on the rating, data and information plates located on the device.
- Before installation, make sure that the device is not damaged.

Commissioning, maintenance, repair

- Only have commissioning and repairs performed by qualified and authorised persons (see "Personnel qualification" chapter).
- Before commissioning, make sure that the device is not damaged.
- Perform only maintenance work described in these operating instructions.

3.4 Modifications and alterations

	DANGER
	<p>Explosion hazard due to modifications and alterations to the device! Non-compliance results in severe or fatal injuries.</p> <ul style="list-style-type: none"> • Do not modify or change the device. • Do not make any changes or modifications to the surface that was applied at the factory.
	<p>No liability or warranty for damage resulting from modifications and alterations.</p>

4 Function and device design

	DANGER
	<p>Explosion hazard due to improper use! Non-compliance results in severe or fatal injuries.</p> <ul style="list-style-type: none"> • Use the device only according to the operating conditions described in these operating instructions. • Use the device only for the intended purpose specified in these operating instructions.

4.1 Function**Application range**

The series YA60/2 signalling device is intended for use in explosive or harsh environments. It is used in gas hazardous areas in Zones 1 and 2, as well as in dust hazardous areas in Zones 21 and 22.

Mode of operation

When activated, the signalling device emits an audible signal, depending on the configuration and device version.

4.2 Device design

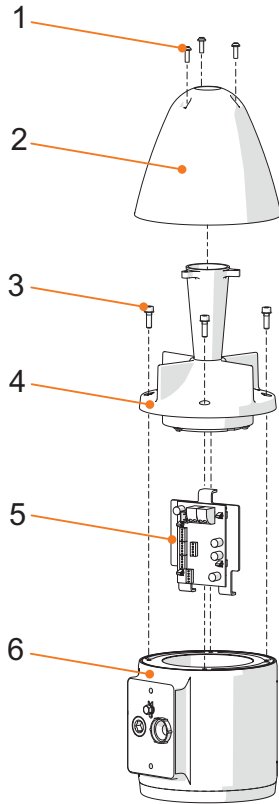

22730E00

- | | | | |
|---|--------------------|---|-------------|
| 1 | Screws | 4 | Horn flange |
| 2 | Horn cover | 5 | PCB |
| 3 | Cheese head screws | 6 | Enclosure |

5 Technical data

Explosion protection

Global (IECEx)

Gas and dust | IECEx EPS 20.0037X
 Ex db IIC T.^{*)} Gb
 Ex tb IIIC T... °C^{*)} Db

Europe (ATEX, UKEX)

Gas and dust | EPS 20 ATEX 1 077 X, CML 21UKEX11047X

⊕ II 2 G Ex db IIC T.^{*)} Gb
 ⊕ II 2 D Ex tb IIIC T... °C^{*)} Db

*) Temperature class	T6	T4
Max. surface temperature (tb)	T80 °C	T100 °C
Ambient temperature range (db)	-45 to +50 °C ¹⁾	-45 to +70 °C ²⁾
Ambient temperature range (tb)	-35 to +50 °C ¹⁾	-35 to +70 °C ²⁾

¹⁾ Loop in/loop out wiring up to max. 10 A

²⁾ Loop in/loop out wiring up to max. 10 A, connection line and cable entries with permissible operating temperature ≥ +90 °C required

North America (UL-certified)

Gas and dust | E161818
 CLASS I DIVISION 1, GROUPS B, C, D; T4
 CLASS I DIVISION 2, GROUPS B, C, D; T4
 CLASS I ZONE 1 AEx db IIC T.^{*)} Gb
 CLASS I ZONE 22 AEx tc IIIC T.^{*)} Dc

*) Temperature class	T6	T4
Max. surface temperature (tb)	T80 °C	T100 °C
Ambient temperature range	-35 to +50 °C ¹⁾	-35 to +66 °C ²⁾

¹⁾ Loop in/loop out wiring up to max. 10 A

²⁾ Loop in/loop out wiring up to max. 10 A, connection line and cable entries with permissible operating temperature ≥ +90 °C required

Special conditions "X"

Repair work on flameproof joints is only permissible in accordance with the values specified by the manufacturer.

The protective covers and loudspeaker trumpets must be installed so that they are protected against electrostatic charge.

The ambient temperature range for dust applications is max. -35 to +50 °C or +70 °C.

For gas Ex applications, the ambient temperature can be as low as -45 °C.

The strength class of the screws (M5 x 16) used must be at least A2-70.

Technical data

Technical data

Product weight | 5.4 kg

Electrical data

Rated operational voltage (input and control input) | ATEX/IECEX:
12 to 24 V DC

UL:
24 V DC

Average input power/
max. current
consumption

Max. current
consumption
[mA]

Average
power
[W]

Horn

300

6

Class

I (PE connection) (internal + external)

Ambient conditions

Functional ambient temperature range | min. -40 °C
max. ambient temperature see certificate

Mechanical data

Degree of protection | IP66 (IEC/EN 60529)

Material

Enclosure | Aluminium 6005A – T6, seawater-resistant

Enclosure colours | Red (RAL 3001)

Horn | ABS, flame retardant

Mounting | Stainless steel

Seal | NBR O-ring seal

Cable entries | 2 cable entries, equipped with:
1 x Exd M20 stopping plug, red
1 x dust cap M20, red

For UL applications, an M20 x 1/2" adaptor is optionally pre-installed.

Technical data

Acoustic data

Volume	≤ 110 dB(A) @ 1 m	
Calculated max. range	Inform [80 dB(A)]	15 m
	Warn [85 dB(A)]	8 m
	Alarm [90 dB(A)]	4 m

Only these settings are evaluated by UL:
 Sound no. 10: 700 Hz with maximum volume ≥ 85 dB(A)
 Sound no. 11: 1000 Hz with maximum volume ≥ 85 dB(A)
 Sound no. 14: 440 Hz with maximum volume ≥ 85 dB(A)
 Sound no. 28: Evacuation pattern ≥ 85 dB(A)

Pole diagram

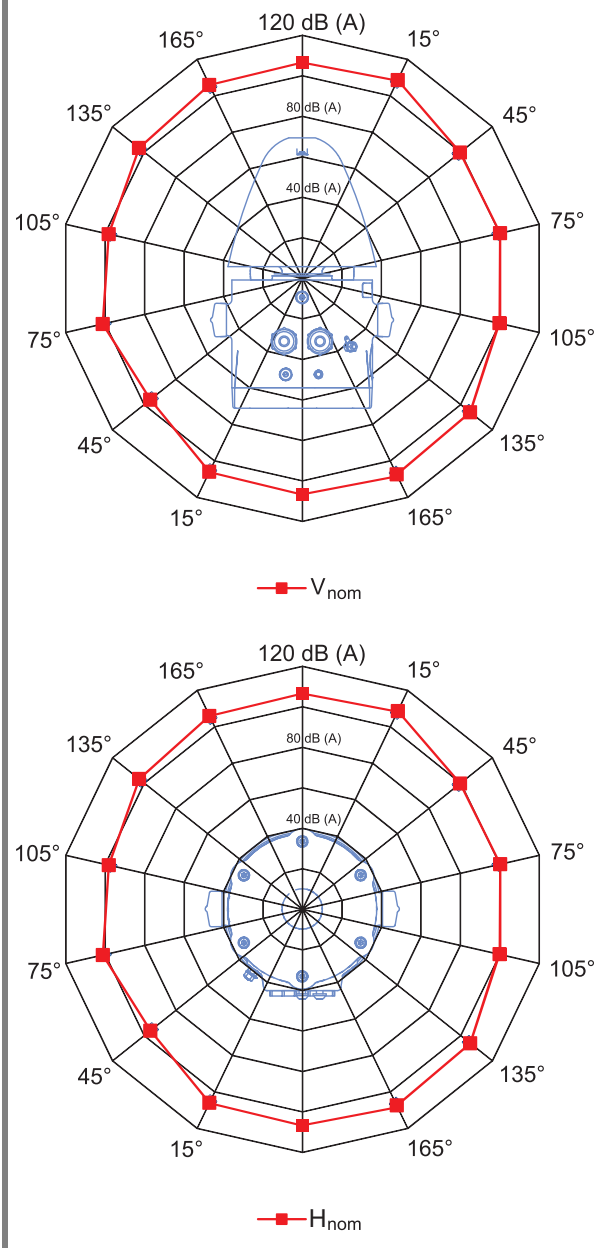

15288E00

22495E00

Technical data

Mounting/installation

Connection type	PUSH-IN terminal
Connection terminals	Solid: max. 2.5 mm ² / AWG 14 Finely stranded: max. 2.5 mm ² / AWG 14
Scope of delivery	- Signalling device according to configuration - L-bracket - Dust caps

For further technical data, see r-stahl.com.

6 Transport and storage

- Transport and store the device only in the original packaging.
- Store the device in a dry place (no condensation) free of vibrations.
- Do not drop the device.

7 Mounting and installation

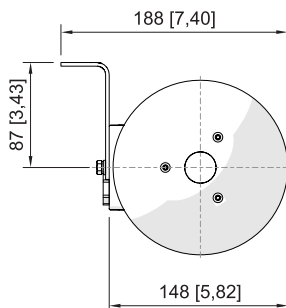
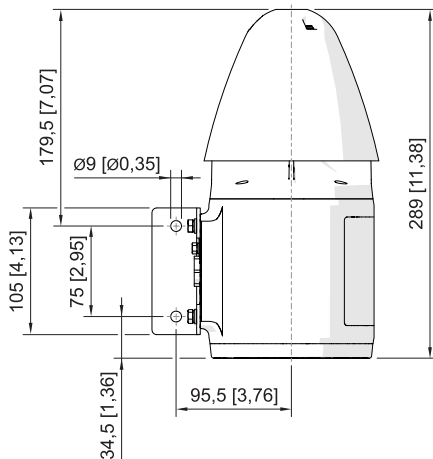

7.1 Dimensions/fastening dimensions

Dimensional drawings (all dimensions in mm [inch]) – Subject to modifications



18382E00

7.2 Mounting/dismounting, operating position

	<p style="text-align: center;">DANGER</p> <p>Explosion hazard due to improper mounting! Non-compliance results in severe or fatal injuries.</p> <ul style="list-style-type: none"> • Only operate the device if it is not damaged. If the thread is damaged, replace the device immediately. • Only install the device in a clean and dry operating environment. • Only mount the device on a wall or on a suitable surface. • Carefully protect exposed joint surfaces from damage, dust and dirt. • Install end flanges without applying force (without hammer and tool) in straight alignment. • If necessary, fit core end sleeves gas-tight and using a suitable tool.
	<p style="text-align: center;">DANGER</p> <p>Explosion hazard due to electrostatic discharge! Non-compliance results in severe or fatal injuries.</p> <p>Do not use the device in strong charge-generating environments.</p> <p>The following processes/activities should be avoided:</p> <ul style="list-style-type: none"> • Accidental friction • Particle flows

	DANGER
<p>Explosion hazard due to open drilled holes, unused cable entries and cable glands!</p> <p>Non-compliance results in severe or fatal injuries.</p> <ul style="list-style-type: none"> • Only use cable entries and stopping plugs that have been separately checked and certified in accordance with Directive 2014/34/EU (ATEX) and IECEx (CoC), and which technically correspond to the state of technology given in the certificate. • For UL applications for Class I Div. 1, the cable glands and stopping plugs must be certified according to the requirements of the applicable marked protection concepts (NEC and CE Code installation codes). • For UL applications for Class I Div. 2, Ex d cable glands and stopping plugs must be used. • The IP level of protection of the cable entries and stopping plugs must at least correspond to the IP level of protection of the device (see marking on the device). • When selecting cable entries, observe the type of thread and thread size in the component documentation. • Seal the thread with non-curing thread sealant in order to guarantee the IP66 degree of protection. • Always close unused drilled holes, cable entries and cable glands using approved stopping plugs or plugs. Observe IEC/EN 60079-14 for this. • Installation of the cable gland must be performed in accordance with the manufacturer's instructions. • The cable entry temperature may exceed 70 °C and cable gland temperature may exceed 80 °C. 	

- Select a mounting location that is suitable for the signal effect of the device, as well as the required mounting and installation parameters (see "Technical data" chapter).
- Mount the device on a flat surface using the L-bracket and screw holes.
- Mount suitable approved electrical lines (see "Technical data" chapter) using a suitable flameproof cable entry.
- Close unused entries using certified, flameproof stopping plugs.

7.3 Installation

The electrical installation and configuration of the device is performed in the following sequence:

- Dismounting the device (see chapter 7.3.1)
- Electrical connections (see chapter 7.3.2)
- Configuration (see chapter 7.3.3)
- Mounting the device (see chapter 7.3.4)
- Mounting the earth connection (see chapter 7.3.5)

7.3.1 Dismounting the device

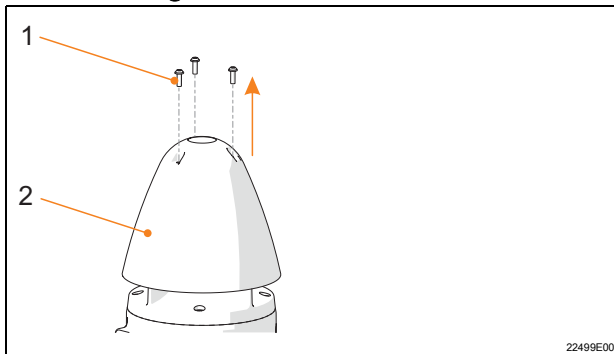
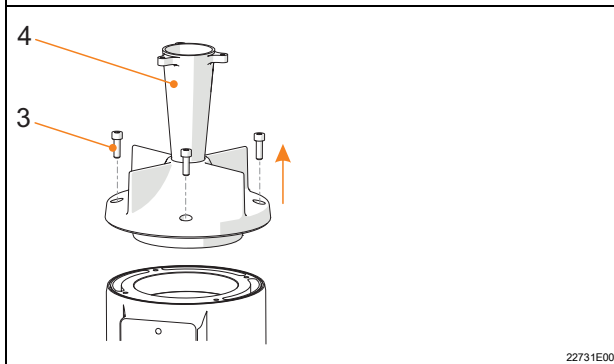
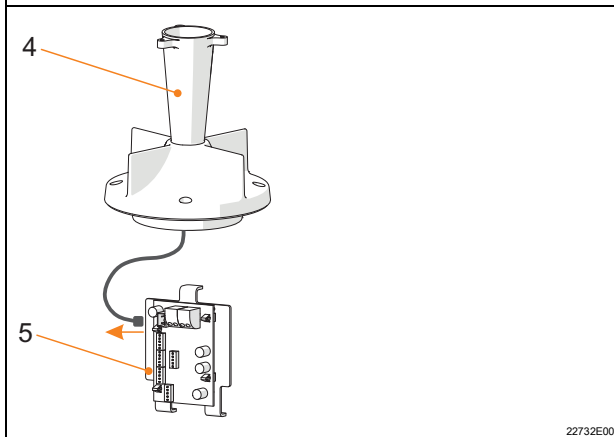
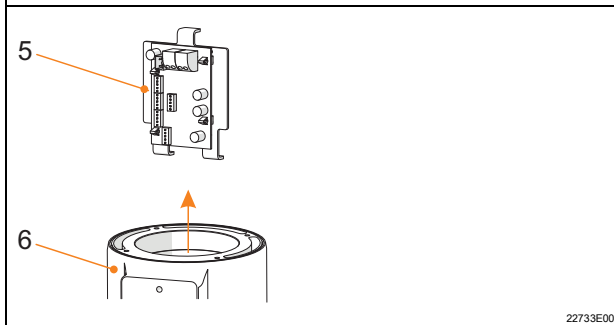
 <p>22499E00</p>	<ul style="list-style-type: none"> Loosen the 3 PT screws (4.0 x 12) (1) and remove the trumpet cover (2).
 <p>22731E00</p>	<ul style="list-style-type: none"> Loosen the 4 cheese-head screws (M5 x 16) (3) and remove the horn flange (4).
 <p>22732E00</p>	<ul style="list-style-type: none"> Disconnect the plug connector between the horn flange (4) and PCB (5).
 <p>22733E00</p>	<ul style="list-style-type: none"> Remove the PCB (5) from the enclosure (6).

7.3.2 Electrical connections

	DANGER
<p>Explosion hazard due to insufficient protective measures! Non-compliance results in severe or fatal injuries.</p> <ul style="list-style-type: none"> • Select suitable cables to ensure that the maximum permissible conductor temperatures are not exceeded. • When using core end sleeves, attach them using a suitable tool. • The conductor insulation must be touching the terminal. • Do not damage the conductor (e.g. nicking) when stripping it. • Finally, check the conductor to ensure that it is secure (fixed). 	

- Insert the pre-installed cabling into the electrical connections provided – see figure.

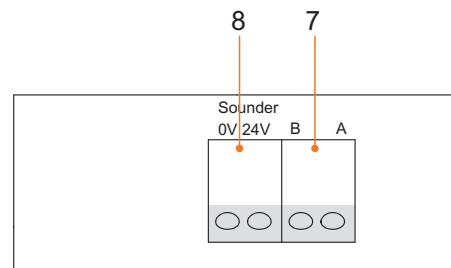
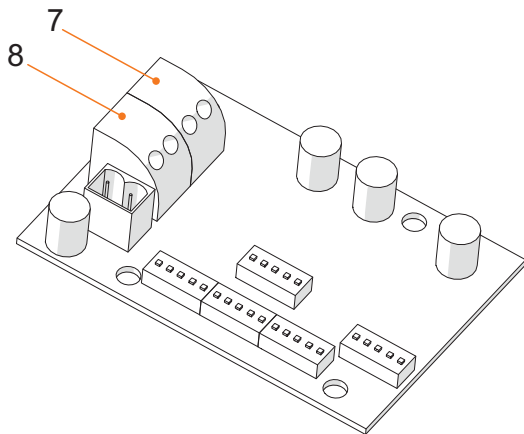

22735E00

22734E00

- 7 Control (A/B signal)
- 8 Audible signal power supply

Connection terminals

Clamping range:

1 x 0.5 to 2.5 mm² / 1 x AWG 21 to 14

(finely stranded without core end sleeve, or solid and finely stranded with core end sleeve)

Stripping length:

8 to 10 mm

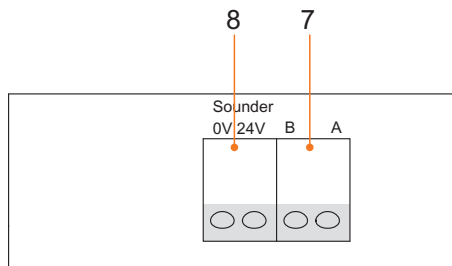

- 0 V = negative potential (DC)
- 24 V = positive potential (DC)
- A, B = control signals

22735E00

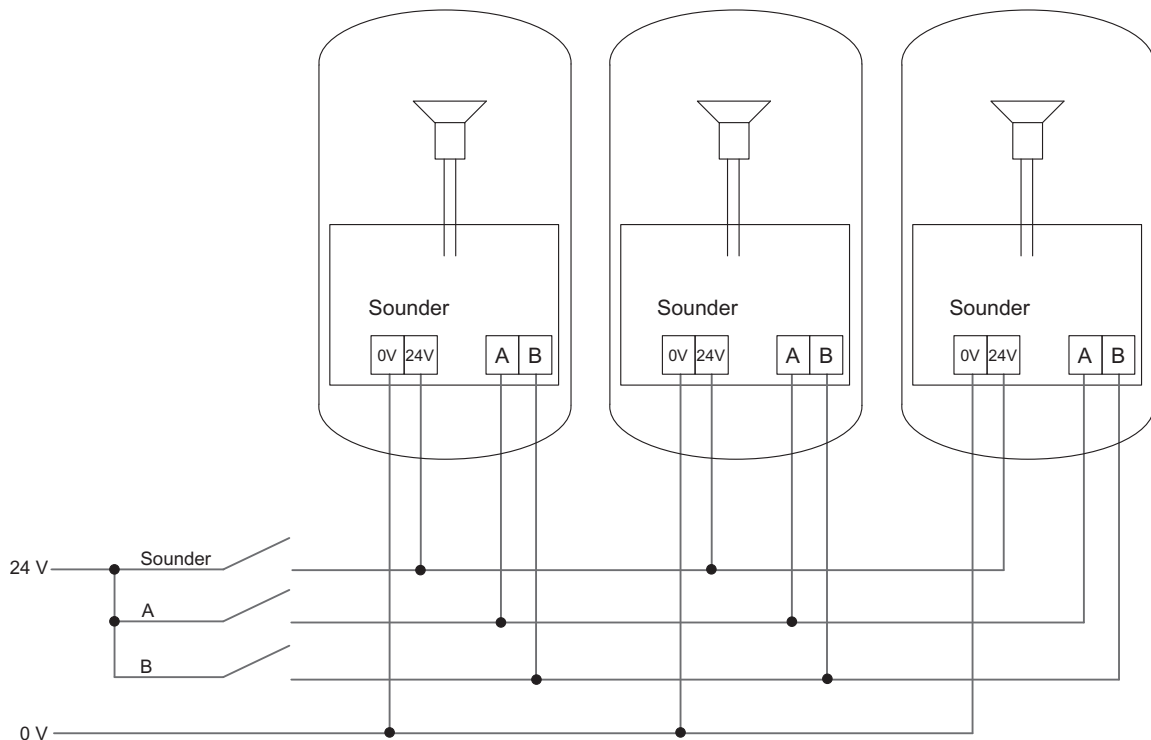

22736E00

Example: Connection diagram for combining multiple devices

When doing so:

- Observe the maximum permissible single wire cross-sections for the connection terminals – see "Technical data" chapter.
- Only such cable entries and stopping plugs may be installed that have been separately tested and certified according to Directive 2014/34/EU (ATEX) and IECEx (CoC); they must also comply technically with the standard version stated in the certificate.
- Use electrical lines with a minimum length of 3 m or a cable gland with compound.

7.3.3 Configuration

The configuration of the device is performed by adjusting the DIP switch on the PCB. The following general/audible configuration options are available:

Horn circuit board

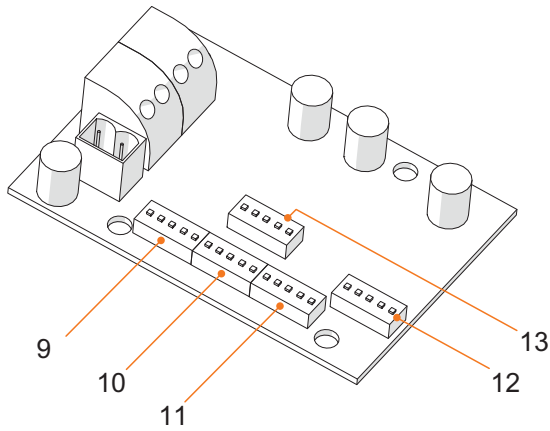

22737E00

	DIP switch designation	Function
9	SW1	Audible settings for sound level 1
10	SW2	Audible settings for sound level 2
11	SW3	Not equipped
12	SW4	Not equipped
13	OPTIONS	General settings



The YA60/2 audible signalling device provides four audible channels with 32 preconfigured tones.

Audible channels

The audible channels can be controlled in the connection area via the A/B control signals using separate cabling.

Tones

Tone 1 and tone 2 can be configured separately using DIP switches (SW1 / SW2).

Tone 3 and tone 4 are dependent on activation via tone selection 1 (SW1).

A tone change for tone 3 and tone 4 can be activated or deactivated separately (see "General settings").

This tone change function is deactivated on delivery.

REMOTE INITIATION

The REMOTE INITIATION function ("RI") is used to activate the audible signal via control line B. RI is deactivated on delivery.

It is activated or deactivated separately – in conjunction with control signal B – using the "OPTIONS" DIP switch.

General settings



"OPTIONS" DIP switch







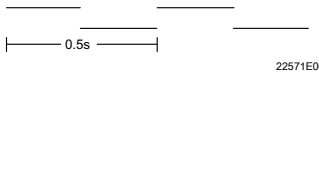
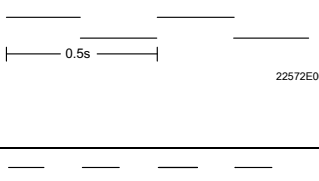
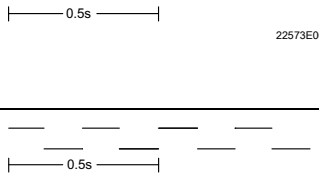
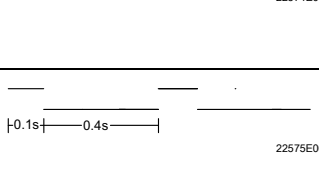
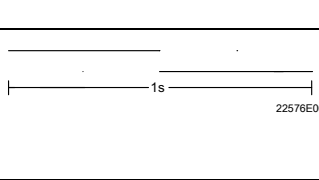
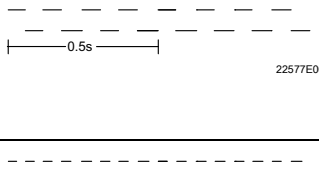
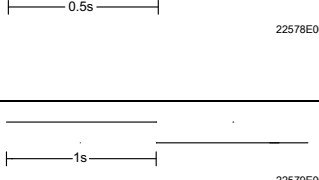
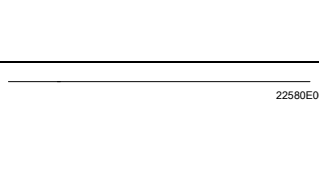
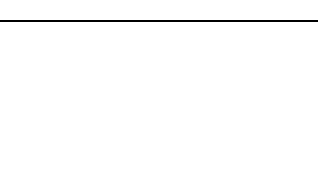

1	2	3	4	5	
			ON	ON	Sound volume reduced by up to 18 dB(A)
			ON	OFF	Sound volume reduced by up to 12 dB(A)
			OFF	ON	Sound volume reduced by up to 6 dB(A)
			OFF	OFF	Max. sound volume
		ON			Reserved
		OFF			Reserved
	ON				SOUND LEVEL 3/4 ACTIVATION (control via A/B signal)
	OFF				SOUND LEVEL 3/4 DEACTIVATION (control via A/B signal)
ON					RI ACTIVATION (active switching via B signal)
OFF					RI DEACTIVATION (active switching via B signal)

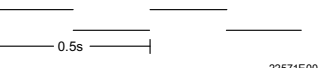
Function of "OPTIONS" DIP switch in combination with control (A/B signal)

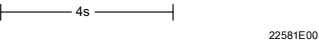
General settings		Control signal		Emitted sound	
RI ACTIVATION	SOUND LEVELS 3/4 ACTIVATION	A	B	SOUND	Sound selection
0	0	0	0	Sound 1	SW1
0	0	1	0	Sound 2	SW2
0	0	0	1	Sound 1	SW1
0	0	1	1	Sound 2	SW2
0	1	0	0	Sound 1	SW1
0	1	1	0	Sound 2	SW2
0	1	0	1	Sound 3	SW1
0	1	1	1	Sound 4	SW1
1	0/1	0	0	Sound deactivated	SW1
1	0/1	1	0	Sound deactivated	SW2
1	0/1	0	1	Sound 1	SW1
1	0/1	1	1	Sound 2	SW2

Audible settings

Sound no.	SW1/SW2					Frequency	Sound description	Special application	Sound level			
	SW x.1	SW x.2	SW x.3	SW x.4	SW x.5				1	2	3	4
									Sound no.	Sound no.	Sound no.	Sound no.
01	0	0	0	0	0	1000 Hz 800 Hz		Changing sound UK BS5839-1 (fire alarm, level crossing)	01	SW2	05	11
02	1	0	0	0	0	3100 Hz 2500 Hz		Safety alarm	02	SW2	04	11
03	0	1	0	0	0	1000 Hz 800 Hz		Increased urgency, level crossing	03	SW2	05	11
04	1	1	0	0	0	3100 Hz 2500 Hz		Security deterrent	04	SW2	02	11
05	0	0	1	0	0	554 Hz 440 Hz		AFNOR (France)	05	SW2	01	14
06	1	0	1	0	0	470 Hz 430 Hz			06	SW2	01	11
07	0	1	1	0	0	1000 Hz 800 Hz			07	SW2	28	11
08	1	1	1	0	0	3200 Hz 2500 Hz			08	SW2	07	11
09	0	0	0	1	0	554 Hz 440 Hz		Turn out (Sweden SS 031711)	09	SW2	01	11
10	1	0	0	1	0	700 Hz		All clear, (Sweden, SS 031711)	10	SW2	01	11

Sound no.	SW1/SW2					Frequency	Sound description	Special application	Sound level			
	SW x.1	SW x.2	SW x.3	SW x.4	SW x.5				1	2	3	4
	Sou-nd no.	Sou-nd no.	Sou-nd no.	Sou-nd no.	Sou-nd no.							
11	0	1	0	1	0	1000 Hz			11	SW2	31	15
12	1	1	0	1	0	2040 Hz 1632 Hz			12	SW2	01	11
13	0	0	1	1	0	2300 Hz			13	SW2	01	14
14	1	0	1	1	0	440 Hz			14	SW2	01	11
15	0	1	1	1	0	1000 Hz			15	SW2	31	11
16	1	1	1	1	0	420 Hz		AS2220, AS1610, AS1670 (Australia)	16	SW2	01	11
17	0	0	0	0	1	1000 Hz			17	SW2	31	11
18	1	0	0	0	1	2500 Hz			18	SW2	10	11
19	0	1	0	0	1	2500 Hz			19	SW2	28	11
20	1	1	0	0	1	700 Hz		Important message (Sweden)	20	SW2	08	11
21	0	0	1	0	1	1000 Hz			21	SW2	28	11

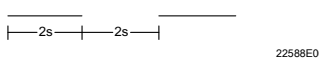
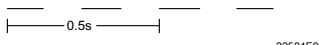
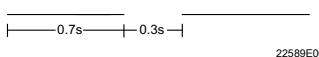
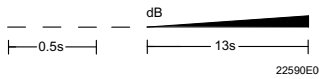
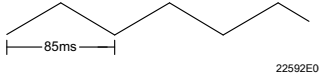
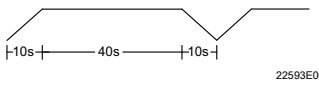
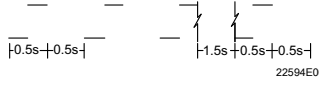
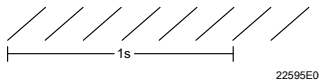
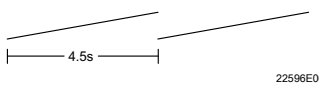
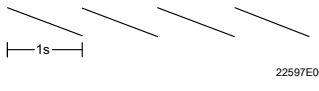
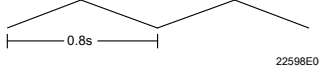
Sound no.	SW1/SW2					Frequency	Sound description	Special application	Sound level			
	SW x.1	SW x.2	SW x.3	SW x.4	SW x.5				1	2	3	4
	Sound no.	Sound no.	Sound no.	Sound no.	Sound no.							
22	1	0	1	0	1	700 Hz	 22588E00	Air-raid alarm (Sweden)	22	SW2	01	11
23	0	1	1	0	1	700 Hz	 22584E00	Local warning (Sweden)	23	SW2	22	11
24	1	1	1	0	1	720 Hz	 22589E00	Industrial alarm (Germany)	24	SW2	08	11
25	0	0	0	1	1	1400 Hz	 22590E00		25	SW2	22	11
26	1	0	0	1	1	1200 Hz 250 Hz	 22592E00		26	SW2	07	11
27	0	1	0	1	1	1000 Hz 250 Hz	 22593E00		27	SW2	31	15
28	1	1	0	1	1	1000 Hz 800 Hz	 22594E00	ISO 8201 (int. evacuation alarm)	28	SW2	08	11
29	0	0	1	1	1	1000 Hz 420 Hz	 22595E00		29	SW2	01	11
30	1	0	1	1	1	1200 Hz 500 Hz	 22596E00	Evacuation, Netherlands	30	SW2	26	11
31	0	1	1	1	1	2500 Hz 500 Hz	 22597E00	DIN 33404 fire alarm (Germany)	31	SW2	15	11
32	1	1	1	1	1	1200 Hz 250 Hz	 22598E00		32	SW2	01	11

7.3.4 Mounting the device

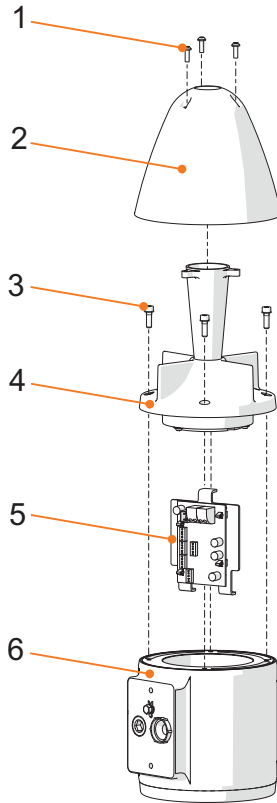

- | | | | |
|---|--------------------|---|-------------|
| 1 | Screws | 4 | Horn flange |
| 2 | Horn cover | 5 | PCB |
| 3 | Cheese head screws | 6 | Enclosure |

22730E00

i

Screws and seals

The cheese-head screws are delivered with Nyltite seals.

- Before mounting, check the seals for damage.
- Replace damaged seals.
- Use seals a maximum of 5 times.
- When using screws on a flat surface, note the seal on the screw head – see figure.

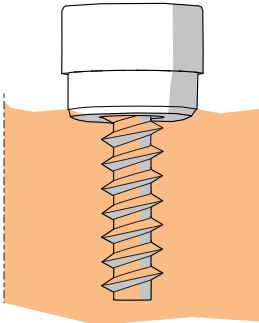
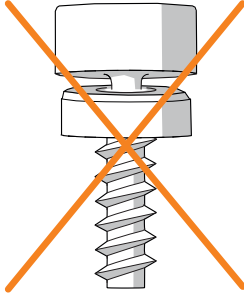
15748E00

 <p>22741E00</p>	<ul style="list-style-type: none"> • Insert the PCB (5) into the enclosure (6).
 <p>22740E00</p>	<ul style="list-style-type: none"> • Connect the plug connector between the horn flange (4) and PCB (5).
 <p>22739E00</p>	<ul style="list-style-type: none"> • Fit the horn flange (4) and mount using 4 cheese-head screws (M5 x 16) (3) (tightening torque 4 Nm).
 <p>22510E00</p>	<ul style="list-style-type: none"> • Fit the trumpet cover (2) and mount using 3 PT screws (4.0 x 12) (1) (tightening torque 0.4 Nm).

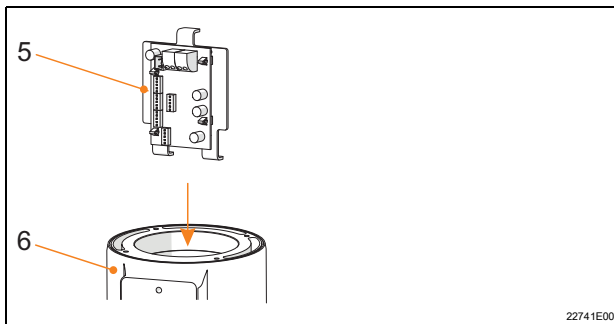
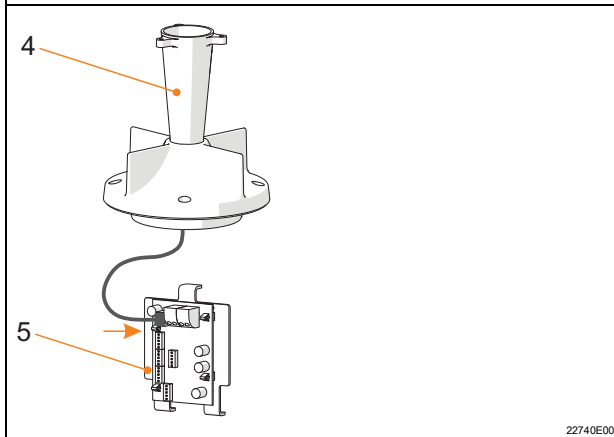
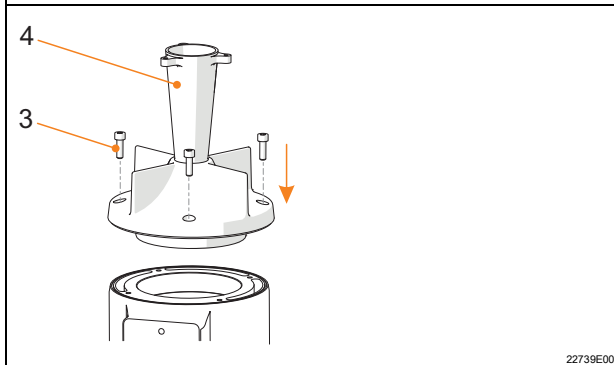
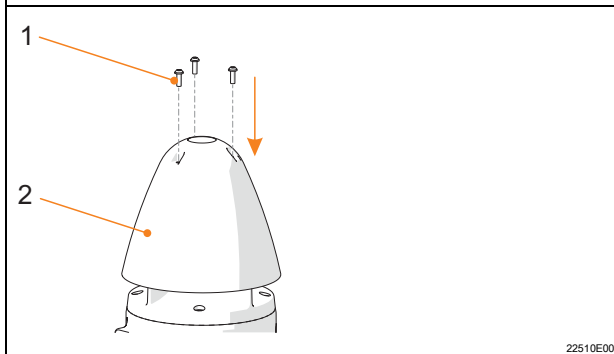
7.3.5 Mounting the earth connection

- Connect the internal earth connection as the primary connection point.

i	The external connection can be used as an additional equipotential bonding conductor, provided that it is permissible or required in accordance with local regulations or by the authorities.
----------	---

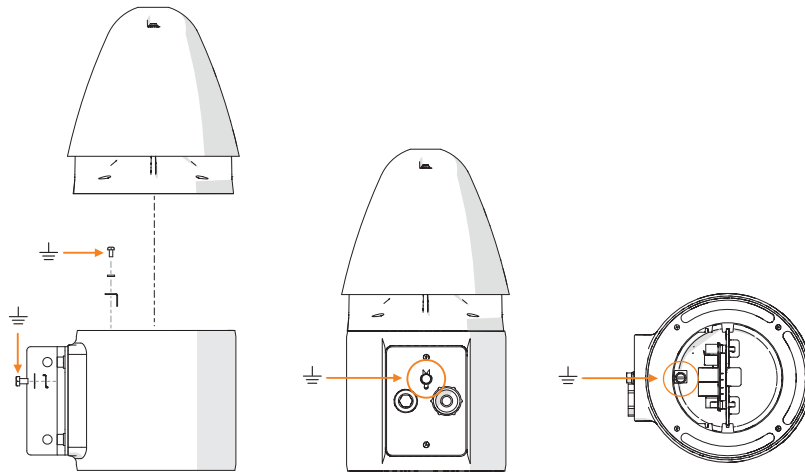

22738E00

8 Commissioning

8.1 Prerequisites

	DANGER
	<p>Explosion hazard due to incorrect installation! Non-compliance results in severe or fatal injuries.</p> <ul style="list-style-type: none"> • Check the device for proper installation before commissioning. • Comply with national regulations.

Before commissioning, make sure that:

- the device has been installed according to regulations.
- the line voltage and the rated operational voltage are consistent.
- the permissible cable diameter for the cable entries has been used.
- the cable entries and stopping plugs have been securely tightened.
- the electrical lines have been connected correctly.
- the connection has been performed correctly.
- all screws and nuts are tightened in accordance with the regulations.
- the connection chamber is clean.
- the device is not damaged.
- there are no foreign objects inside the device.
- the device is closed according to regulations.

8.2 Testing

For commissioning, the line voltage must correspond to the rated operational voltage. When doing so, the following pre-configured functions can be tested, see figure:

- Audible signal
- Control functions (A/B signal)

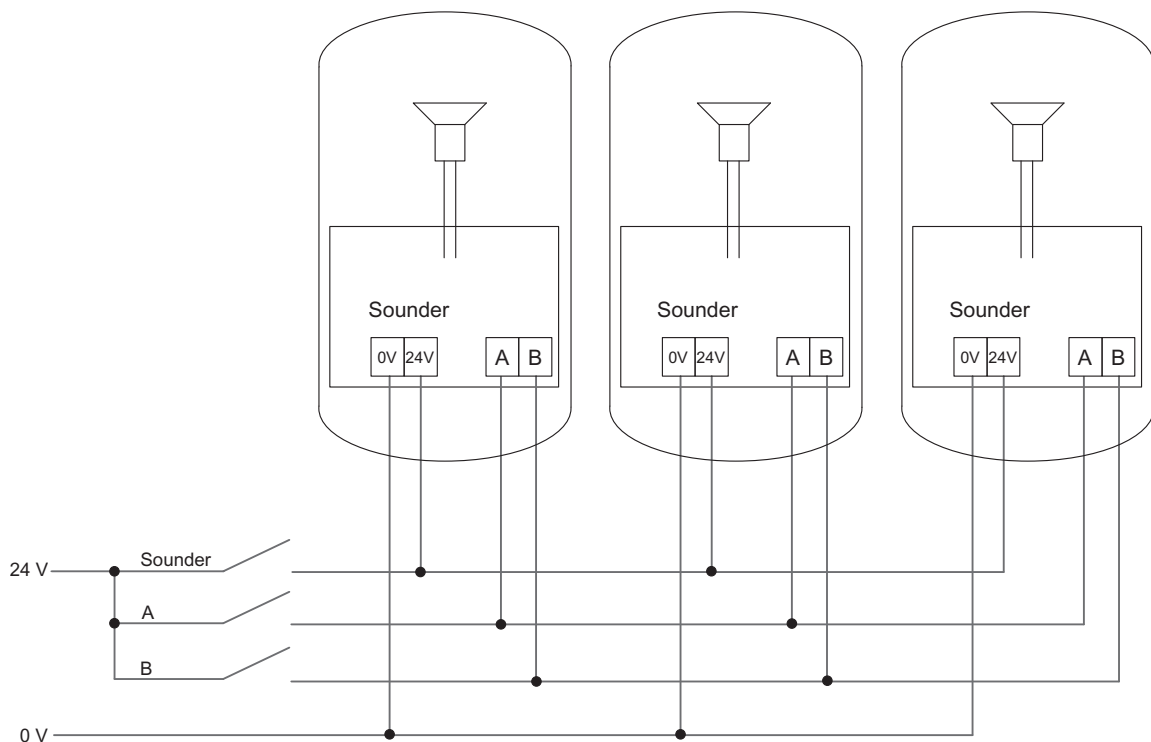

22736E00

9 Operation

The device is used to warn and alert by means of

- an audible signal.

9.1 Troubleshooting

If the error cannot be eliminated using the specified procedures:

- Contact R. STAHL Schaltgeräte GmbH.

For rapid processing, have the following information ready:

- Type and serial number of the device
- Purchase information
- Error description
- Intended purpose (especially input/output circuit)

10 Maintenance, overhaul, repair

10.1 Maintenance and overhaul

- Consult the relevant national regulations to determine the type and extent of inspections.
- Tailor inspection intervals to the operating conditions.
- Perform maintenance and repair work in accordance with IEC 60079-17 and IEC 60079-19.

	Observe the relevant national regulations in the country of use.
---	--

At a minimum, check the following points during maintenance on the device:

- Whether the conductors are clamped securely
- Whether the device has cracks or other visible signs of damage
- Whether the seals have aged or been damaged
- Compliance with the permissible temperatures (according to EN 60079)
- Whether the device is used as intended and functions properly

10.2 Repair

	DANGER
	<p>Explosion hazard due to improper repair! Non-compliance results in severe or fatal injuries.</p> <ul style="list-style-type: none"> • Repair work on the devices must be performed only by R.STAHL Schaltgeräte GmbH.

10.3 Returning the device

- Only return or package the devices after consulting R. STAHL!
Contact the responsible representative from R. STAHL.

R. STAHL's customer service is available to handle returns if repair or service is required.

- Contact customer service personally.

or

- Go to the r-stahl.com website.
- Under "Support" > "RMA" > select "RMA-REQUEST".
- Fill out the form and send it.
You will automatically receive an RMA form via email.
Please print this file off.
- Send the device along with the RMA form in the packaging to
R. STAHL Schaltgeräte GmbH (refer to chapter 1.1 for the address).

11 Cleaning

- Devices located in hazardous areas may only be cleaned with a damp cloth to avoid electrostatic charge.
- When cleaning with a damp cloth, use water or mild, non-abrasive, non-scratching cleaning agents.
- Do not use abrasive cleaning agents or solvents.
- Never clean the device with a strong water jet, e.g. a pressure washer!

12 Disposal

- Observe national, local and statutory regulations regarding disposal.
- Separate materials for recycling.
- Ensure environmentally friendly disposal of all components according to statutory regulations.

13 Accessories and spare parts

NOTICE

Malfunction or damage to the device due to the use of non-original components.
Non-compliance may lead to material damage!

- Use only original accessories and spare parts from R. STAHL Schaltgeräte GmbH.



For accessories and spare parts, see the data sheet on our homepage
r-stahl.com.

EU-Konformitätserklärung
EU Declaration of Conformity
Déclaration de Conformité UE



R. STAHL Schaltgeräte GmbH • Am Bahnhof 30 • 74638 Waldenburg, Germany
 erklärt in alleiniger Verantwortung, *declares in its sole responsibility, déclare sous sa seule responsabilité,*

dass das Produkt: **Akustische und optische Signalgeräte**
that the product: *Audible and visual signalling devices*
que le produit: *Appareil de signalisation sonore et lumineux*

Typ(en), type(s), type(s): **YL60/2, YA60/2, FL60/2**

mit den Anforderungen der folgenden Richtlinien und Normen übereinstimmt.
is in conformity with the requirements of the following directives and standards.
est conforme aux exigences des directives et des normes suivantes.

Richtlinie(n) / Directive(s) / Directive(s)		Norm(en) / Standard(s) / Norme(s)
2014/34/EU	ATEX-Richtlinie	EN IEC 60079-0:2018
2014/34/EU	<i>ATEX Directive</i>	EN 60079-1:2014
2014/34/UE	<i>Directive ATEX</i>	EN 60079-31:2014

Kennzeichnung, marking, marquage:  **II 2 G Ex db IIC T6/T4 Gb**  **0158**
II 2 D Ex tb IIIC T 80 °C/T100 °C Db

EU-Baumusterprüfbescheinigung: **EPS 20 ATEX 1077 X**
EU Type Examination Certificate: (Bureau Veritas Consumer Products Services Germany GmbH,
Attestation d'examen UE de type: Businesspark A96, 86842 Tuerkheim, Germany)

Produktnormen nach Niederspannungsrichtlinie: EN 60598-1:2015/ A1:2018
Product standards according to Low Voltage Directive: EN 62471:2008
Normes des produit pour la Directive Basse Tension:

2014/30/EU	EMV-Richtlinie	EN 50130-4:2011/ A1:2014
2014/30/EU	<i>EMC Directive</i>	EN 61000-6-3:2007/+ A1:2011/ AC:2012
2014/30/UE	<i>Directive CEM</i>	

2011/65/EU	RoHS-Richtlinie	EN 50581:2012
2011/65/EU	<i>RoHS Directive</i>	
2011/65/UE	<i>Directive RoHS</i>	

Waldenburg, 2021-06-11

Ort und Datum
Place and date
Lieu et date

i.V.

Dr. C. Chevalier
Vice President BU Lighting & Signalling
Vice-Président BU Eclairage & Appareils de signalisation

i.V.

J. Freimüller
Vice President global Quality Management
Vice-Président globale Gestion de Qualité

UK Declaration of Conformity

UK-Konformitätserklärung



R. STAHL Schaltgeräte GmbH • Am Bahnhof 30 • 74638 Waldenburg, Germany

represented locally by, *lokal vertreten durch*

R. STAHL LTD. • 2nd Floor, Bromwich Court, Gorse Lane, Coleshill • Birmingham B46 1JU, UK
 declares in its sole responsibility, *erklärt in alleiniger Verantwortung,*

that the product: **Audible and visual signalling devices**
dass das Produkt: **Akustische und optische Signalgeräte**

Type(s), *Typ(en)*: **YL60/2, YA60/2, FL60/2**

is in conformity with the requirements of the following regulations and standards.
mit den Anforderungen der folgenden Verordnungen und Normen übereinstimmt.

Regulation(s) / <i>Verordnung(en)</i>	Standard(s) / <i>Norm(en)</i>
S.I. 2016/1107 Equipment and Protective Systems Intended for Use in Potentially Explosive Atmospheres Regulations <i>S.I. 2016/1107 Verordnung für Geräte und Schutzsysteme zur bestimmungsgemäßen Verwendung in explosionsgefährdeten Bereichen</i>	EN IEC 60079-0:2018 EN 60079-1:2014 EN 60079-31:2014
Marking, <i>Kennzeichnung:</i>	 II 2G Ex db IIC T6 / T4 Gb II 2D Ex tb IIIC T80 °C / T100 °C Db UK CA 8505
UK Type Examination Certificate: <i>UK-Baumusterprüfbescheinigung:</i>	CML 21UKEX11047X (Eurofins E&E CML Limited, Newport Business Park, New Port Road, Ellesmere Port, Cheshire, CH65 4LZ, UK, AB2503)
Product standards according to S.I. 2016/1101 Electrical Equipment (Safety) Regulation <i>Produktnormen nach S.I. 2016/1101 (Sicherheits-) Verordnung für elektronische Geräte</i>	EN 60598-1:2015 + A1:2018 EN 62471:2008
S.I. 2016/1091 EMC Regulations <i>S.I. 2016/1091 EMV-Verordnung</i>	EN 50130-4:2011 + A1:2014 EN 61000-6-3:2007 + A1:2011 + AC:2012
S.I. 2012/3032 RoHS Regulations <i>S.I. 2012/3032 RoHS-Verordnung</i>	EN IEC 63000:2018

Waldenburg, 2024-01-16

Place and date
Ort und Datum

i.V.

S. Holtz
Head of R&D - BU Lighting & Signalling
Leiter Entwicklung Leuchten und Signalgerät

i.V.

D. Groth
Vice President global Quality Management
Leiter globales Qualitätsmanagement