



## GRP Flameproof Visual Signal Xenon or Steady LED

Series FX15

## Contents

1	General Information .....	2
1.1	Manufacturer .....	2
1.2	Information regarding the operating instructions .....	2
1.3	Conformity with standards and regulations .....	3
2	Symbols Used .....	3
3	General Safety Notes .....	3
3.1	Storage of these Operating Instructions .....	3
3.2	Modifications and alterations .....	4
3.3	Special Versions .....	4
4	Intended Use .....	4
5	Technical data .....	5
6	Transport and storage .....	7
7	Installation .....	8
7.1	Dimensions / fastening dimensions .....	8
7.2	Installation Conditions .....	9
7.3	Assembling and Operating Position .....	9
7.4	Installation conditions for electrical connections .....	10
7.5	Access to the PCB .....	10
7.6	Reassembly of Enclosure .....	11
7.7	Electrical Connection .....	11
7.8	Earth Connection .....	12
8	Putting into Service .....	12
9	Maintenance, overhaul and repair .....	12
9.1	Regular maintenance work .....	12
10	Cleaning .....	13
11	Disposal .....	13
12	Accessories and Spare Parts .....	13

## 1 General Information

### 1.1 Manufacturer

R. STAHL Schaltgeräte GmbH  
 Business Unit Lighting & Signalling  
 Nordstr. 10  
 99427 Weimar  
 Germany

Phone: +49 3643 4324  
 Fax: +49 3643 4221-76  
 Internet: [www.stahl-ex.com](http://www.stahl-ex.com)  
 E-mail: [info@stahl.de](mailto:info@stahl.de)

R. STAHL Schaltgeräte GmbH  
 Am Bahnhof 30  
 74638 Waldenburg  
 Germany

Phone: +49 7942 943-0  
 Fax: +49 7942 943-4333  
 Internet: [www.stahl-ex.com](http://www.stahl-ex.com)  
 E-mail: [info@stahl.de](mailto:info@stahl.de)

### 1.2 Information regarding the operating instructions





ID-No.: 218095 / FX1560300010  
 Publication Code: 2017-05-08·BA00·III·en·06



### 1.3 Conformity with standards and regulations

Conformity with standards and regulations is specified in the corresponding certificates and the EC Declaration of Conformity. These documents can be downloaded from our homepage [www.stahl-ex.com](http://www.stahl-ex.com).





## 2 Symbols Used

	<p><b>Safety instructions</b>  <b>Non-observance can result in damage to equipment, serious injuries or death.</b>                  The safety instructions contained in these operating instructions and affixed to the device must be observed!</p>
	<p><b>Warning symbol</b>                  Danger due to explosive atmosphere!</p>
	<p><b>Warning symbol</b>                  Danger due to live parts!</p>
	<p><b>Notice</b>                  This graphic marks important additional information, tips and recommendations.</p>

## 3 General Safety Notes

### 3.1 Storage of these Operating Instructions

Read these operating instructions carefully and store them near the installation place. For correct operation, please observe all other documents enclosed in this delivery and the operating instructions of the equipment to be connected.



 <b>WARNING</b>	
	<p><b>Use the devices only for their intended purpose!</b>                  ► We cannot be held liable for damage caused by an incorrect or unauthorized use or by non-observance of these operating instructions.                  ► Use the device only if it is undamaged.</p>
 <b>WARNING</b>	
	<p><b>Any unauthorized work on the device is prohibited!</b>                  Installation, maintenance, overhaul and repair may only be carried out by appropriately authorized and trained personnel.</p>

**Observe the following information during installation and operation:**

- Any damage may compromise the explosion protection
- National and local safety regulations
- National and local accident prevention regulations
- National and local assembly and installation regulations

- Generally recognized technical regulations
- Safety notes in these operating instructions
- Characteristic values and rated operating conditions on the rating plates and data plates
- Additional information plates on the device

### 3.2 Modifications and alterations

 <b>WARNING</b>	
	<b>Alterations and modifications to the device are not permitted.</b> We shall not accept any liability or warranty obligations for damage resulting from alterations and modifications.

### 3.3 Special Versions

In case of additional/different order options, special versions may differ from the description given here.

## 4 Intended Use

Product Series FX15 is a robust, rugged, GRP visual signal, designed for use in hazardous areas. The device can be used to alert, warn or draw attention to machine malfunction/start up or any number of fire & safety related applications. In addition to the xenon beacon, an LED steady version is available for continuous use when process status indication is required. In hazardous areas the devices have explosion protection for ATEX/IECEx zones 1 + 2 for gas and 21 + 22 for dust. The device is suitable for Gas groups IIB or IIC, Dust group IIIC.

The life of the xenon flash tube is guaranteed for the following number of flashes:

Variant:	Number of flashes:
5 J	2 million

The LED variant is designed for continuous use and has a lifetime of 100,000 Hrs if used within the standard operating parameters. See technical data section.

## 5 Technical data

### Explosion Protection

#### Global (IECEx)

Gas and dust

IIB	IECEx BAS 13.0005X
IIC	IECEx BAS 13.0003
IIB, IIC	IEC 60079-0: 2011 / IEC 60079-1: 2007-04 / IEC 60079-31: 2008
IIB	Ex d IIB T* Gb (Ta = -60 ... +** °C) Ex tb IIIC T***°C Db IP 66 (Ta = -60 ... +** °C)
IIC	Ex d IIC T* Gb (Ta = -60 ... +** °C) Ex tb IIIC T***°C Db IP 66 (Ta = -60 ... +** °C)

\* temperature class on the table

#### Europe (ATEX)

Gas and dust

IIB	Baseefa13ATEX0007X
IIC	Baseefa13ATEX0006
IIB, IIC	EN 60079-0: 2012 / EN 60079-1: 2007 / EN 60079-31: 2009
IIB	⊕ II 2 G Ex d IIB T* Gb (Ta = -60 ... +** °C) ⊕ II 2 D Ex tb IIIC T***°C Db IP 66 (Ta = -60 ... +** °C)
IIC	⊕ II 2 G Ex d IIC T* Gb (Ta = -60 ... +** °C) ⊕ II 2 D Ex tb IIIC T***°C Db IP 66 (Ta = -60 ... +** °C)

\* temperature class on the table

#### Product variant table

5 Joule Xenon Strobe

Power and voltage	Temperature class	Max. surface temperature	Ambient temperature range
5 J 24 V DC	T6	T73 °C	-60 ... +40 °C
	T5	T88 °C	-60 ... +55 °C
	T4	T103 °C	-60 ... +70 °C
5 J 48 V DC	T6	T73 °C	-60 ... +40 °C
	T5	T88 °C	-60 ... +55 °C
	T4	T103 °C	-60 ... +70 °C
5 J 60 V DC	T5	T90 °C	-60 ... +40 °C
	T4	T110 °C	-60 ... +60 °C
5 J 115 V AC	T5	T83 °C	-60 ... +40 °C
	T4	T113 °C	-60 ... +55 °C
5 J 230 V AC	T6	T75 °C	-60 ... +40 °C
	T5	T90 °C	-60 ... +55 °C
	T4	T105 °C	-60 ... +70 °C

**Explosion Protection**

Steady LED	Power and voltage	Temperature class	Max. surface temperature	Ambient temperature range
	see certificate	T6	T85 °C	-60 ... +70 °C
	see certificate	T6	T85 °C	-60 ... +70 °C

**Certifications and certificates**

Certificates	IECEX, ATEX, Brazil (INMETRO), India (PESO), Kazakhstan (TR), Russia (TR), Belarus (TR)
--------------	---

**Technical Data**

**Electrical data**

Version	5 Joule Xenon Beacon					Steady LED				
Rated operational voltage	24 V DC, 48 V DC, 60 V DC, 115 V AC and 230 V AC operational parameters +/-10 %					24 V DC +/-10 %, 100 ... 254 V AC				
Rated operational current	<b>24 V DC</b>	<b>48 V DC</b>	<b>60 V DC</b>	<b>115 V AC</b>	<b>230 V AC</b>		Nominal			
							<b>24 V DC</b>	<b>110 V AC</b>	<b>230 V AC</b>	
Power	300 mA	185 mA	150 mA	140 mA	75 mA	green	150 mA	34 mA	16 mA	
						red	109 mA	25 mA	12 mA	
						amber	113 mA	26 mA	12 mA	
						blue	133 mA	30 mA	15 mA	
						white	139 mA	31 mA	15 mA	
								Nominal		
							<b>24 V DC</b>	<b>110 V AC</b>	<b>230 V AC</b>	
						green	3.6 W	3.7 W	3.7 W	
						red	2.6 W	2.7 W	2.8 W	
						amber	2.7 W	2.8 W	2.8 W	
					blue	3.2 W	3.3 W	3.3 W		
					white	3.3 W	3.4 W	3.5 W		

**Luminous characteristics**

Version	5 Joule Xenon Beacon					Steady LED			
Effective candela	Clear lens	49 cd				green	51 cd		
						red	37 cd		
Luminous flux	not applicable					amber	33 cd		
						blue	20 cd		
						white	72 cd		
						green	45 lm		
						red	44 lm		
Flash energy	5 J					amber	40 lm		
						blue	24 lm		
						white	72 lm		
						--	--		
						--	--		
Flash rate	1 per second					--	--		



**Technical Data**

Colour definition	green	colour pigmented polycarbonate lens	green	505 nm
	red		red	625 nm
	amber		amber	590 nm
	blue		blue	475 nm
	clear		white	Cx = 0.34, Cy = 0.33
	yellow		yellow	white LED under colour pigmented polycarbonate lens
	opal		opal	
	magenta		magenta	
Status LED lifetime	not applicable		100,000 hours	
<b>Operating temperature range</b>				
Version	5 Joule Xenon Beacon		Steady LED	
	24 & 48 V DC	-50 ... +70 °C	-60 ... +50 °C	
	60 V DC	-60 ... +60 °C		
	115 V AC	-55 ... +55 °C		
	230 V AC	-55 ... +70 °C		
<b>Mechanical data</b>				
Material				
Enclosure	GRP			
Lens cover	polycarbonate			
Wire guard	stainless steel			
Degree of protection	IP66 & IP67 IEC 60529			
Cable entries	3 x M20, product supplied with 3 x dust cover			
Weight	2.4 kg			

## 6 Transport and storage

- Transport and storage are permitted only in the original packaging.
- The devices must be stored in a dry place and vibration-free.
- Do not discard any packing material until installation is complete.

## 7 Installation

### 7.1 Dimensions / fastening dimensions

Dimensional Drawings (All Dimensions in mm) - Subject to Alterations

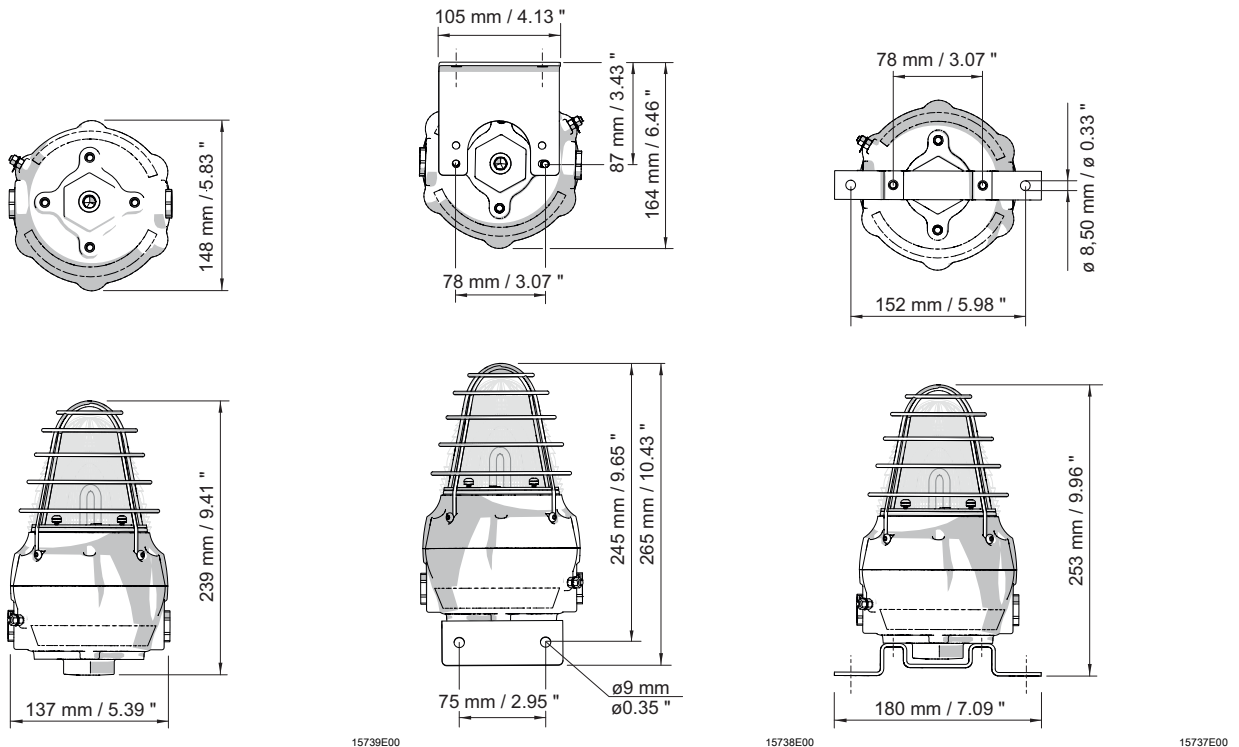

Beacon dimensions

Beacon with 'L' bracket

Beacon with backstrap bracket

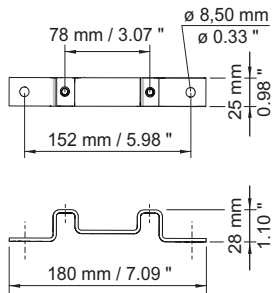



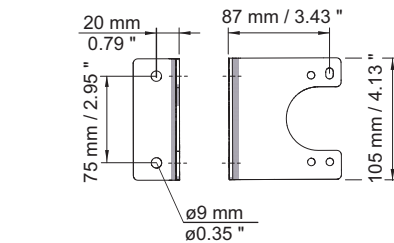



Mounting bracket bolting dimensions





L-shaped bracket bolting dimensions



## 7.2 Installation Conditions

 <b>WARNING</b>	
	<p><b>Risk of electric shock!</b> Before opening the device, disconnect it from the power supply.</p>
 <b>WARNING</b>	
	<p><b>No explosion protection if components are damaged or incorrectly installed!</b></p> <ul style="list-style-type: none"> <li>▶ Operate the device only if it is not damaged.</li> <li>▶ If the thread is damaged, the device must be replaced immediately.</li> <li>▶ Take extreme care when handling the device and internal components.</li> <li>▶ Particular care is needed when accessing the PCB for installation.</li> <li>▶ Exposed joint surfaces must be protected and not have contact with dust or dirt, or be knocked against any object.</li> <li>▶ The end flanges must be fitted squarely and on no account is force to be used.</li> <li>▶ The flange must not be hammered, levered with a metal instrument or the fixing screws used to pull down the flange.</li> <li>▶ With care and patience, it will be found that the flange enters the body without difficulty.</li> <li>▶ Install the device only in a clean and dry operating environment.</li> </ul>
<b>NOTE</b>	
	<p><b>Check the following:</b></p> <ul style="list-style-type: none"> <li>▶ Do you have the correct device to satisfy the system specification?</li> <li>▶ Are the gas group and temperature range of the product suitable for the intended application?</li> <li>▶ Is the supply voltage correct?</li> <li>▶ Is the strobe the correct colour?</li> <li>▶ Is a suitable mounting location available?</li> </ul>
<b>NOTE</b>	
	<p><b>Danger due to electrostatic discharge.</b></p> <p>Electronic components can be destroyed if touched. Do not touch the LED-PCBs!</p>



## 7.3 Assembling and Operating Position

 <b>WARNING</b>	
	<p><b>Incorrectly installed components!</b></p> <ul style="list-style-type: none"> <li>▶ Explosion protection cannot be guaranteed any more if the components are incorrectly installed.</li> <li>▶ When terminal sleeves are fitted, they must be gas-tight and applied with a suitable tool.</li> </ul>

- Select a suitable location with regard to the area to be covered by the FX15.
- The surface should be flat in the area of the fixings (See 7.1 for fastening dimensions) and the material suitable to carry the weight of the FX15.

## 7.4 Installation conditions for electrical connections

### Cable entry to device

 <b>WARNING</b>	
	<p><b>No explosion protection if non-approved cable glands are used!</b></p> <ul style="list-style-type: none"> <li>▶ Only cable glands with a corresponding certificate may be used. They must be flameproof (Ex d), suitable for the type of cable used and fulfil the requirements of IEC/EN 60079-14.</li> <li>▶ Cable entry temperature may reach 70 °C.</li> <li>▶ To ensure the required ingress protection, installation of the cable gland must be performed in accordance with the manufacturer's instructions.</li> <li>▶ For unused enclosure holes use Ex d stopping plugs, for unused cable glands Ex d plugs. Make sure that these components have an appropriate approval and fulfil the requirements of IEC/EN 60079-14.</li> <li>▶ All threaded cable entries to be fitted with an appropriately certified component and the thread sealed with a suitable non-setting thread sealant to maintain IP 66 rating.</li> </ul>

## 7.5 Access to the PCB

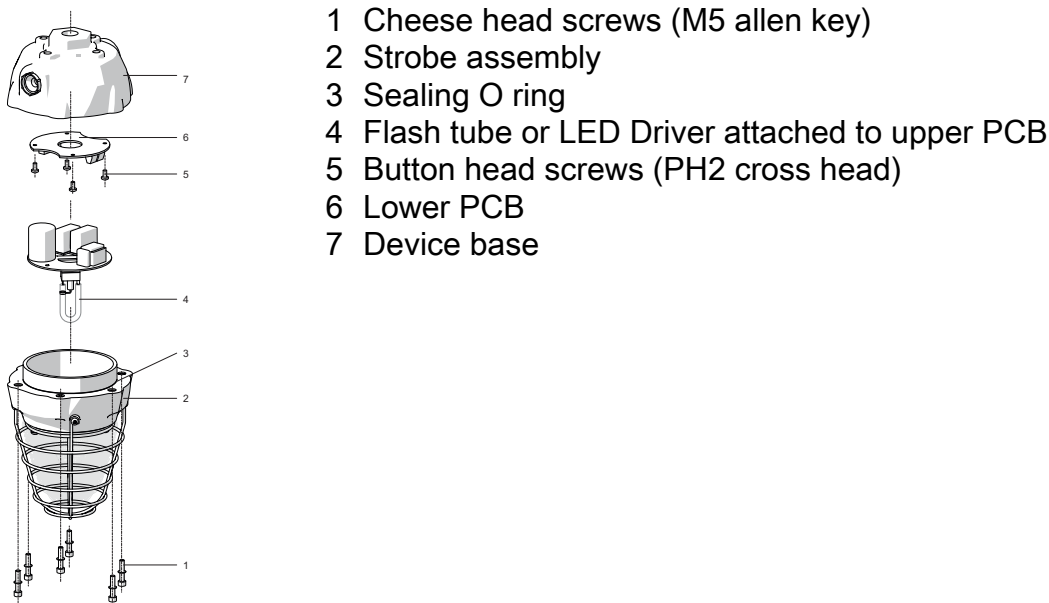

15755E00

### Exploded diagram accessing the PCB FX15

The diagram depicts the Xenon flash tube variant of the FX15. The upper PCB components of the LED variant are different to the Xenon variant however the fundamental build of both products is the same.

#### Instructions

- Remove cheese head screws (M5 allen key) x 6
- Lift strobe assembly and disconnect upper and lower PCB's
- Set aside strobe assembly and upper PCB and terminate wires on lower PCB

## 7.6 Reassembly of Enclosure

- With wires terminated, reconnect upper and lower PCB.
- Carefully insert strobe assembly into base, take care when fitting the assembly it must be fitted squarely into the base. Do not use force, with patience it will be found that the assembly enters without difficulty.
- Replace cheese head screws (M5 allen key).

<b>NOTE</b>	
	▶ Cheese head screws should be tightened with a torque of 3 to 3.05 Nom.

## 7.7 Electrical Connection

### 7.7.1 Key Components

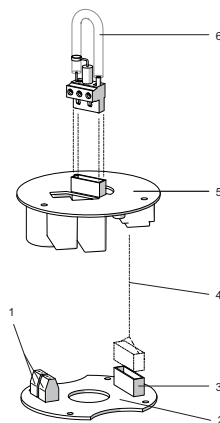

Key components FX15

15756E00

- 1 Terminals
- 2 Lower PCB base board
- 3 PCB connector
- 4 Connecting wire
- 5 Upper PCB
- 6 Flash tube (not present with LED variants)

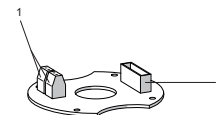

Lower PCB key components FX15 for xenon flash and LED versions

15757E00

### 7.7.2 Cable Connection

<b>NOTE</b>	
	▶ The terminals accept wires of 2.5 mm <sup>2</sup> or 14 ... 18 AWG.

### 7.7.3 Wiring Diagrams for Xenon and LED variants

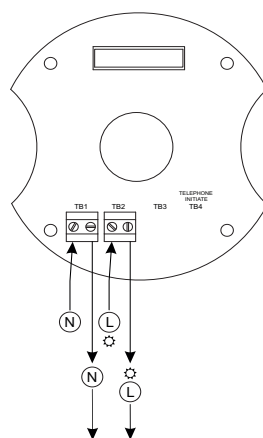

Wiring diagram FX15 AC

15759E00

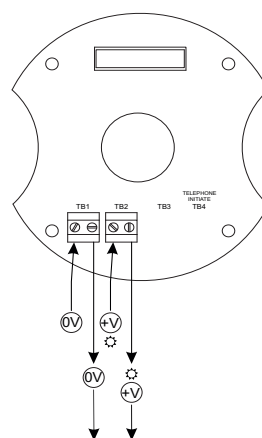

Wiring diagram FX15 DC

15758E00

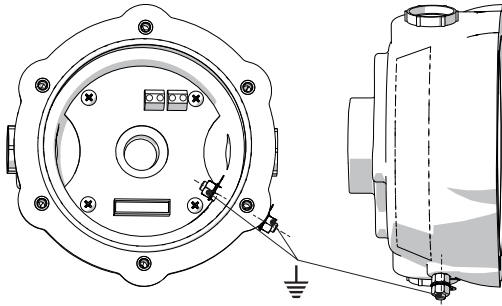

## 7.8 Earth Connection

- FX15 must be connected to a good quality earth.
- The internal Earth connection is the primary point. The external connection is for a supplementary bonding connection and is used where local code or authorities permit or require such connection.



15761E00



## 8 Putting into Service

 <b>WARNING</b>	
	<b>Check the device before commissioning!</b> To ensure the correct operation, check the device before commissioning.

### Before commissioning, ensure that:

- no components are damaged
- the device has been installed according to regulations
- there are no foreign bodies inside the device
- all screws and nuts have been firmly tightened
- the prescribed tightening torques have been observed
- connection has been made correctly

## 9 Maintenance, overhaul and repair

 <b>WARNING</b>	
	<b>Risk due to unauthorized work being performed on the device!</b> ▶ Risk of injury and damage to equipment. ▶ Assembly, installation, commissioning, operation and maintenance must only be carried out by appropriately authorized and trained personnel.

### 9.1 Regular maintenance work

- Consult the relevant national regulations (e.g. IEC/EN 60079-17) to determine the type and extent of inspections.
- Plan the intervals such that any expected defects in the equipment are detected promptly.

### To check as part of maintenance:

- Check if the cables are clamped properly.
- Inspect the device for signs of visible damage.
- Compliance with the permitted temperatures in accordance with IEC/EN 60079-0.
- Make sure that the device is used according to its designated use.

## 10 Cleaning

- Clean with a cloth, brush, vacuum cleaner or similar items.
- When cleaning with a damp cloth, use water or mild, non-abrasive, non-scratching cleaning agents.
- Never use aggressive cleaning agents or solvents.

## 11 Disposal

- Observe the national waste disposal regulations.

## 12 Accessories and Spare Parts

<b>⚠ WARNING</b>	
	<p><b>If wrong accessories are used, explosion protection cannot be guaranteed!</b></p> <p>Use only original R. STAHL spare parts.</p>

The FX15 is sold without a bracket, customers can choose from the following stainless steel brackets:

### Backstrap bracket

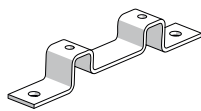

15741E00

Isometric view of FX15 mounting bracket

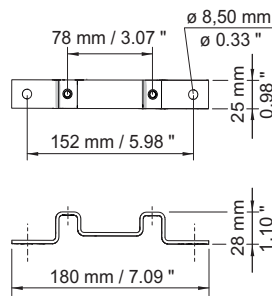

15743E00

Mounting bracket bolting dimensions

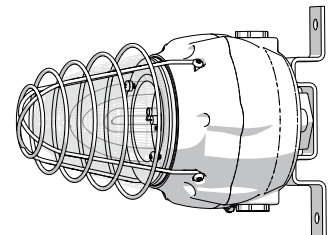

15763E00

FX15 with mounting bracket

### 'L' Bracket

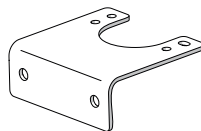

15740E00

Isometric view of L-shaped mounting bracket

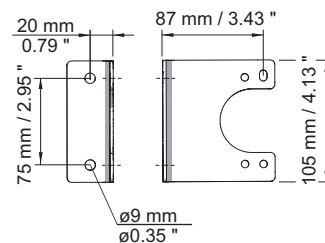

15742E00

L-shaped bracket bolting dimensions

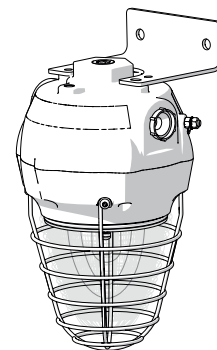

15762E00

FX15 with mounting L-shaped bracket

It is permitted for customers to replace certain components of the FX15.

The following parts are available for sale

- Strobe assembly (including wire guard)
- Replacement bracket assembly kit
- Upper PCB (including flash tube & connection wire)
- Lower PCB

Please contact your local STAHL sales office for part numbers and prices.

NOTE	
	No further alterations are permitted and customers should follow the returns guidelines on the RMA service form (sent with the product)

**EG/EU-Konformitätserklärung**  
*EC/EU Declaration of Conformity*  
*Déclaration de Conformité CE/UE*



**R. STAHL Schaltgeräte GmbH • Am Bahnhof 30 • 74638 Waldenburg, Germany**  
 erklärt in alleiniger Verantwortung, *declares in its sole responsibility, déclare sous sa seule responsabilité,*

dass das Produkt: **GRP Optisches Signal 5 Joule, druckfest gekapselt**  
*that the product: GRP Flameproof Visual Signal 5 Joule*  
*que le produit: Feu flash GRP 5 Joule, antidéflagrant*

Typ(en), type(s), type(s): **FX15B**

mit den Anforderungen der folgenden Richtlinien und Normen übereinstimmt.  
*is in conformity with the requirements of the following directives and standards.*  
*est conforme aux exigences des directives et des normes suivantes.*

Richtlinie(n) <i>Directive(s)</i> <i>Directive(s)</i>		Norm(en) <i>Standard(s)</i> <i>Norme(s)</i>
<b>Bis/Until/Jusque</b> <b>2016-04-19:</b>	<b>Ab/From/De</b> <b>2016-04-20:</b>	EN 60079-0:2012 + A11:2013 EN 60079-1:2014 EN 60079-31: 2014
<b>94/9/EG:</b> ATEX-Richtlinie	<b>2014/34/EU:</b>	
<b>94/9/EC:</b> ATEX Directive	<b>2014/34/EU:</b>	
<b>94/9/CE:</b> Directive ATEX	<b>2014/34/UE:</b>	

Kennzeichnung, marking, marquage:

II 2 G Ex d IIB T\* Gb  
 II 2 D Ex tb IIIC T\*\*\*°C Db

0158

EG-Baumusterprüfbescheinigung:  
*EC Type Examination Certificate:*  
*Attestation d'examen CE de type:*

**Baseefa 13 ATEX 0007X**  
 (Baseefa Ltd., Rockhead Business Park Staden Lane, Buxton Derbyshire, SK17 9RZ United Kingdom)

Produktnormen nach Niederspannungsrichtlinie:  
*Product standards according to Low Voltage Directive:*  
*Normes des produit pour la Directive Basse Tension:*

EN 60947-1: 2007 + A1: 2011/A2:2014

**Bis/Until/Jusque**  
**2016-04-19:**

**Ab/From/De**  
**2016-04-20:**

EN 61000-6-1: 2007  
 EN 61000-6-2: 2006  
 EN 61000-6-3: 2007 + A1: 2011 / AC:2012  
 EN 61000-6-4: 2007 + A1: 2011

**2004/108/EG:** EMV-Richtlinie  
**2004/108/EC:** EMC Directive  
**2004/108/CE:** Directive CEM

**2014/30/EU:**  
**2014/30/EU:**  
**2014/30/UE:**

**2011/65/EU** RoHS-Richtlinie  
**2011/65/EU** RoHS Directive  
**2011/65/UE** Directive RoHS

EN 50581: 2012

Waldenburg, 01.02.2016

i.V.

Ort und Datum  
*Place and date*  
*Lieu et date*

Dr. A. Kaufmann  
 Leiter BU Leuchten & Signalgeräte  
*Head of BU Lightings & Signalling*  
*Directeur BU Eclairage & Appareils de Signal*

i.V.

J.-P. Rückgauer  
 Leiter Qualitätsmanagement  
*Director Quality Management*  
*Directeur Assurance de Qualité*

**EG/EU-Konformitätserklärung**  
*EC/EU Declaration of Conformity*  
*Déclaration de Conformité CE/UE*



**R. STAHL Schaltgeräte GmbH • Am Bahnhof 30 • 74638 Waldenburg, Germany**  
 erklärt in alleiniger Verantwortung, declares in its sole responsibility, déclare sous sa seule responsabilité,

dass das Produkt: **GRP Optisches Signal 5 Joule, druckfest gekapselt**  
 that the product: *GRP Flameproof Visual Signal 5 Joule*  
 que le produit: *Feu flash GRP 5 Joule, antidéflagrant*

Typ(en), type(s), type(s): **FX15C**

mit den Anforderungen der folgenden Richtlinien und Normen übereinstimmt.  
 is in conformity with the requirements of the following directives and standards.  
 est conforme aux exigences des directives et des normes suivantes.

Richtlinie(n) Directive(s) Directive(s)	Norm(en) Standard(s) Norme(s)
<b>Bis/Until/Jusque</b> <b>2016-04-19:</b>	<b>Ab/From/De</b> <b>2016-04-20:</b>
<b>94/9/EG:</b> ATEX-Richtlinie	EN 60079-0:2012 + A11:2013
<b>94/9/EC:</b> ATEX Directive	EN 60079-1:2014
<b>94/9/CE:</b> Directive ATEX	EN 60079-31: 2014
<b>2014/34/EU:</b>	
<b>2014/34/EU:</b>	
<b>2014/34/UE:</b>	

Kennzeichnung, marking, marquage:

II 2 G Ex d IIC T\* Gb  
 II 2 D Ex tb IIIC T\*\*\*°C Db

**CE 0158**

EG-Baumusterprüfbescheinigung:  
 EC Type Examination Certificate:  
 Attestation d'examen CE de type:

**Baseefa 13 ATEX 0006**  
 (Baseefa Ltd., Rockhead Business Park Staden Lane, Buxton  
 Derbyshire, SK17 9RZ United Kingdom)

Produktnormen nach Niederspannungsrichtlinie:  
 Product standards according to Low Voltage Directive:  
 Normes des produit pour la Directive Basse Tension:

EN 60947-1: 2007 + A1: 2011/A2:2014

**Bis/Until/Jusque**  
**2016-04-19:**

**Ab/From/De**  
**2016-04-20:**

EN 61000-6-1: 2007  
 EN 61000-6-2: 2006  
 EN 61000-6-3: 2007 + A1: 2011 / AC:2012  
 EN 61000-6-4: 2007 + A1: 2011

**2004/108/EG:** EMV-Richtlinie  
**2004/108/EC:** EMC Directive  
**2004/108/CE:** Directive CEM

**2014/30/EU:**  
**2014/30/EU:**  
**2014/30/UE:**

**2011/65/EU** RoHS-Richtlinie  
**2011/65/EU** RoHS Directive  
**2011/65/UE** Directive RoHS

EN 50581: 2012

Waldenburg, 01.02.2016

i.V.

Ort und Datum  
 Place and date  
 Lieu et date

**Dr. A. Kaufmann**  
 Leiter BU Leuchten & Signalgeräte  
 Head of BU Lightings & Signalling  
 Directeur BU Eclairage & Appareils de Signal

i.V.

**J.-P. Rückgauer**  
 Leiter Qualitätsmanagement  
 Director Quality Management  
 Directeur Assurance de Qualité