



Tubular Light Fitting with LED

Series 6036

Contents

1	General Information	3
1.1	Manufacturer	3
1.2	Information regarding the operating instructions	3
1.3	Further documents	3
1.4	Conformity with standards and regulations	3
2	Explanation of the symbols	4
2.1	Symbols in these operating instructions	4
2.2	Warning notes	4
2.3	Symbols on the device	5
3	Safety notes	5
3.1	Operating instructions storage	5
3.2	Safe use	5
3.3	Intended Use	6
3.4	Modifications and alterations	6
4	Function and device design	6
4.1	Function	6
4.2	Device design	7
5	Technical data	8
6	Transport and storage	17
7	Mounting and installation	18
7.1	Dimensions / fastening dimensions	18
7.2	Removing protective foil	18
7.3	Mounting / dismounting, operating position	19
7.4	Installation	21
8	Commissioning	21
9	Maintenance, Overhaul, Repair	22
9.1	Maintenance	22
9.2	Repair	22
9.3	Returning the device	23
10	Cleaning	23
11	Disposal	23
12	Accessories and Spare parts	23

1 General Information

1.1 Manufacturer

R. STAHL Schaltgeräte GmbH
Business Unit Lighting & Signalling
Nordstr. 10
99427 Weimar
Germany

Phone: +49 3643 4324
Fax: +49 3643 4221-76
Internet: r-stahl.com
E-mail: info@r-stahl.com

R. STAHL Schaltgeräte GmbH
Am Bahnhof 30
74638 Waldenburg
Germany

Phone: +49 7942 943-0
Fax: +49 7942 943-4333
Internet: r-stahl.com
E-mail: info@r-stahl.com

1.2 Information regarding the operating instructions

ID-No.: 224538 / 603660300010
Publication Code: 2022-04-25-BA00-III-en-15

1.3 Further documents

- Data sheet

For documents in additional languages, see r-stahl.com.

1.4 Conformity with standards and regulations

IECEX, ATEX, EU Declaration of Conformity and further national certificates can be downloaded via the following link: <https://r-stahl.com/en/global/support/downloads/>.
IECEX is also available at: <http://iecex.iec.ch/>

2 Explanation of the symbols

2.1 Symbols in these operating instructions

Symbol	Meaning
	Tips and recommendations on the use of the device
	Danger due to explosive atmosphere
	Danger due to live components
	Risk of damage to the eyes caused by optical radiation



2.2 Warning notes

Warnings must be observed under all circumstances, in order to minimize the risk due to construction and operation. The warning notes have the following structure:

- Signalling word: DANGER, WARNING, CAUTION, NOTICE
- Type and source of danger/damage
- Consequences of danger
- Taking countermeasures to avoid the danger or damage

	DANGER
	Danger to persons Non-compliance with the instruction results in severe or fatal injuries to persons.
	WARNING
	Danger to persons Non-compliance with the instruction can result in severe or fatal injuries to persons.
	CAUTION
	Danger to persons Non-compliance with the instruction can result in light injuries to persons.
NOTICE	
Avoiding material damage Non-compliance with the instruction can result in material damage to the device and / or its environment.	

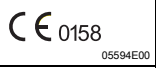
2.3 Symbols on the device

Symbol	Meaning
 0158 <small>05594E00</small>	CE marking according to the currently applicable directive.
 <small>02198E00</small>	According to marking, device approved for hazardous areas.

3 Safety notes

3.1 Operating instructions storage

- Read the operating instructions carefully.
- Store the operating instructions at the mounting location of the device.
- Observe applicable documents and operating instructions of the devices to be connected.

3.2 Safe use

Before mounting

- Read and observe the safety notes in these operating instructions!
- Ensure that the contents of these operating instructions are fully understood by the personnel in charge.
- Use the device in accordance with its intended and approved purpose only.
- Always consult R. STAHL Schaltgeräte GmbH if using the device under operating conditions which are not covered by the technical data.
- We cannot be held liable for damage to the device caused by incorrect or unauthorised use or non-compliance with these operating instructions.

For assembly and installation

- Observe national assembly and installation regulations (e.g. IEC/EN 60079-14).
- Observe national safety and accident prevention regulations.
- During installation and operation, observe the information (characteristic values and rated operating conditions) on the type plates and data plates and information signs located on the device.
- Before installation, make sure that the device is not damaged.

Maintenance, repair, commissioning

- Before commissioning, make sure that the device is not damaged.
- Work on the device, such as installation, maintenance, overhaul, repair, may only be carried out by appropriately authorised and trained personnel.
- Perform only maintenance work or repair described in these operating instructions.



3.3 Intended Use

The tubular light fitting 6036 is equipment

- for lighting areas, work spaces and objects
- can be used indoors and outdoors
- for stationary mounting
- for use in Zones 1, 21, 2, 22 and in the safe area

In treatment plants and retaining basins, tubular light fittings from size 2 onwards are recommended.

3.4 Modifications and alterations

	DANGER
	<p>Explosion hazard due to modifications and alterations to the device! Non-compliance results in severe or fatal injuries.</p> <ul style="list-style-type: none"> • Do not modify or alter the device.
	<p>No liability or warranty for damage resulting from modifications and alterations.</p>

4 Function and device design

	DANGER
	<p>Explosion hazard due to improper use! Non-compliance results in severe or fatal injuries.</p> <ul style="list-style-type: none"> • Use the device only in accordance with the operating conditions described in these operating instructions. • Use the device only for the intended purpose specified in these operating instructions.

4.1 Function

	DANGER
	<p>Explosion hazard if device is used in aggressive ambient conditions! Non-compliance results in severe or fatal injuries.</p> <ul style="list-style-type: none"> • Do not use the device in environments with kerosene, ammonia or phosphorus vapours.

Application range

The tubular light fitting is equipment used for lighting areas, work equipment and objects. It can be used indoors and outdoors.

4.2 Device design

EN

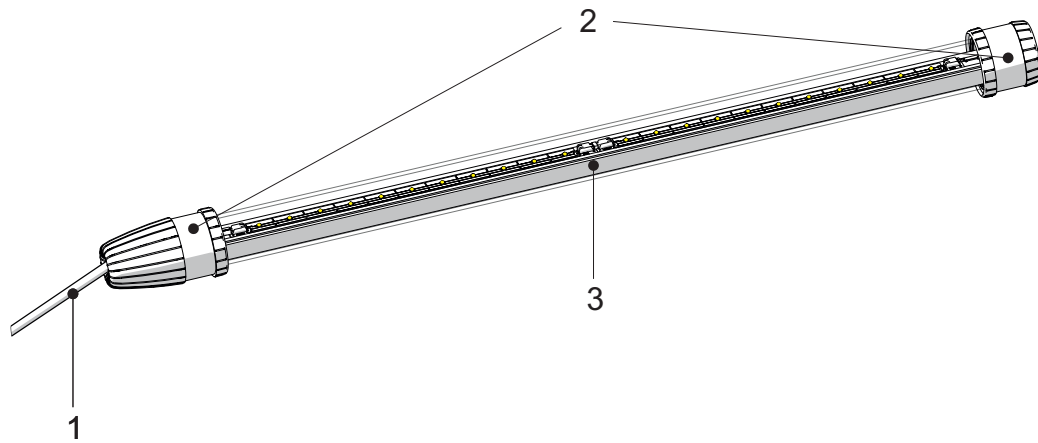

- 1 Connection line
- 2 Rubber caps including mounting surfaces
- 3 Polycarbonate tube with LED insert

5 Technical data

Explosion Protection

Global (IECEX)

Gas, dust and mining	IECEX EPS 13.0027 Ex db op is IIC T* Gb Ex tb IIIC T* °C Db Ex db op is I Mb * temperature classes and surface temperatures see technical data
----------------------	--

Europe (ATEX)

Gas, dust and mining	EPS 13 ATEX 1 597 ⊕ II 2 G Ex db op is IIC T* Gb ⊕ II 2 D Ex tb IIIC T* °C Db ⊕ I M 2 Ex db op is I Mb * temperature classes and surface temperatures see technical data
----------------------	--

Certifications and certificates

Certificates	IECEX, ATEX, Brazil (INMETRO), Kazakhstan (TR), Russia (TR), Belarus (TR)
Ship approval	DNV GL

Technical Data

Electrical data

Rated operational voltage	Size 1, 12 V (6036/1212-..2-0...-..): 12 V DC
	Size 1, 24 to 48 V (6036/1212-..3-0...-..): 24 to 48 V AC/DC 0, 50 to 60 Hz
	Size 1, 110 to 240 V (6036/1212-..5-0...-..): 110 to 240 V AC/DC; 0, 50 to 60 Hz
	Size 2, 220 to 240 V (6036/1225-..0-0...-..): 220 to 240 V AC; 50 to 60 Hz 209 to 240 V DC
	Size 3, 220 to 240 V (6036/1235-..0-0...-..): 220 to 240 V AC; 50 to 60 Hz 209 to 240 V DC
	Size 4, 220 to 240 V (6036/1248-..0-0...-..): 220 to 240 V AC; 50 to 60 Hz 209 to 240 V DC

Technical Data

Voltage range

Size 1, 12 V (6036/1212-...2-0...-...):
10.8 to 13.2 V DC
Size 1, 24 to 48 V (6036/1212-...3-0...-...):
21.6 to 52.8 V AC/DC; 0, 50 to 60 Hz
Size 1, 110 to 240 V (6036/1212-...5-0...-...):
99 to 264 V AC/DC; 0, 50 to 60 Hz
Size 2, 220 to 240 V (6036/1225-...0-0...-...):
198 to 264 V AC; 50 to 60 Hz
188 to 264 V DC
Size 3, 220 to 240 V (6036/1235-...0-0...-...):
198 to 264 V AC; 50 to 60 Hz
188 to 264 V DC
Size 4, 220 to 240 V (6036/1248-...0-0...-...):
198 to 264 V AC; 50 to 60 Hz
188 to 264 V DC

Rated operational current

Size 1:
1.30 A (12 V)
0.70 A (24 V)
0.30 A (48 V)
0.13 A (110 V)
0.07 A (240 V)
Size 2:
0.13 A (230 V)
Size 3:
0.18 A (230 V)
Size 4:
0.25 A (230 V)

Inrush current

Size 1:

maximum number of luminaires per miniature circuit breaker:

U _n [V]	I _{peak} [A]	Δt [μs]	B10A	B16A	C10A	C16A
24	27	290	6	10	10	20
48	58	360	3	5	5	9
110	2	960	28	45	47	75
230	4	810	16	26	27	44

Size 2 to 4:

maximum number of luminaires per miniature circuit breaker:

Size	U _n [V]	I _{peak} [A]	Δt [μs]	B10A	B16A	C10A	C16A
2	230	13	38	61	98	61	98
3	230	13	38	44	71	44	71
4	230	13	38	32	51	32	51

Technical Data

Power factor $\cos \varphi$	Size 1: N/A (12 V) N/A (24 V) N/A (48 V) > 0.90 (110 V) > 0.85 (230 V) Size 2 to 4: > 0.95 (230 V)
THD	Size 1: N/A (12 V) N/A (24 V) N/A (48 V) < 38% (110 V) < 46% (230 V) Size 2 to 4: < 23% (230 V)

Luminous characteristics

Standard
 Light colour: neutral white
 Colour temperature [K]: 5,000 K
 Colour rendering R_a : ≥ 80
 Application example: lighting of desktops
LED: High-Power, one-row arrangement

Size	Voltage	Without diffuser		With diffuser		Narrow-beam 20°	
		Luminous flux [lm]	Luminaire efficacy [lm/W]	Luminous flux [lm]	Luminaire efficacy [lm/W]	Luminous flux [lm]	Luminaire efficacy [lm/W]
1	12 V						
	24 to 48 V						
	110 to 240 V	1,443	111	1,277	98	1,371	105
2	220 to 240 V	2,995	111	2,651	98	2,845	105
3	220 to 240 V	4,492	114	3,976	101	4,267	108
4	220 to 240 V	5,990	118	5,301	105	5,691	112

Technical Data

LED: Mid-Power, one-row arrangement

Size	Voltage	Without diffuser		With diffuser		20° optics		Batwing optics	
		Luminous flux [lm]	Luminaire efficacy [lm/W]	Luminous flux [lm]	Luminaire efficacy [lm/W]	Luminous flux [lm]	Luminaire efficacy [lm/W]	Luminous flux [lm]	Luminaire efficacy [lm/W]
1	12 V 24 to 48 V 110 to 240 V	1,599	119	1,396	104	1,389	104	1,357	101
2	220 to 240 V	3,261	128	2,847	112	2,834	111	2,768	109
3	220 to 240 V	4,886	133	4,266	116	4,246	115	4,147	113
4	220 to 240 V	6,385	133	5,575	116	5,549	116	5,419	112

Alternative

Light colour: Warm white
 Colour temperature [K]: 4,000 K
 Colour rendering R_a: ≥80
 Application example: lighting of desktops

Light colour: Daylight
 Colour temperature [K]: 6,500 K
 Colour rendering R_a: ≥70 at LED High-Power
 Colour rendering R_a: ≥80 at LED Mid-Power
 Application example: Lighting outside areas

For the luminous flux and light efficiency, see the table above (LED: Mid-Power, one-row arrangement)

Yellow phosphorus converted

Light colour: yellow
 Application example: no impact on animals in lighting

Size	Voltage	Without diffuser		With diffuser	
		Luminous flux [lm]	Luminaire efficacy [lm/W]	Luminous flux [lm]	Luminaire efficacy [lm/W]
1	12 V 24 to 48 V 110 to 240 V	1,057	79	935	70
2	220 to 240 V	2,349	84	2,079	74
3	220 to 240 V	3,523	87	3,118	77
4	220 to 240 V	4,698	90	4,157	80

Technical Data

Monochromatic yellow

Light colour: yellow
 Application example: lighting of areas for processing materials sensitive to UV light and blue light such as photo development laboratories

Size	Voltage	Without diffuser		With diffuser	
		Luminous flux [lm]	Luminaire efficacy [lm/W]	Luminous flux [lm]	Luminaire efficacy [lm/W]
1	24 to 48 V 110 to 240 V	392	38	347	33
4	220 to 240 V	1,744	41	1,543	37

Blue

Light colour: blue
 Application example: marking of fire extinguishing equipment

Size	Voltage	Without diffuser		With diffuser	
		Luminous flux [lm]	Luminaire efficacy [lm/W]	Luminous flux [lm]	Luminaire efficacy [lm/W]
1	12 V 24 to 48 V 110 to 240 V	406	30	359	27
2	220 to 240 V	902	32	798	29
3	220 to 240 V	1,353	33	1,197	30
4	220 to 240 V	1,804	34	1,596	31

Technical Data

Green

Light colour: green

Application example: eyewash stations, safety showers and in the offshore area and near ports

Size	Voltage	Without diffuser		With diffuser	
		Luminous flux [lm]	Luminaire efficacy [lm/W]	Luminous flux [lm]	Luminaire efficacy [lm/W]
1	12 V 24 to 48 V 110 to 240 V	758	56	671	50
2	220 to 240 V	1,685	60	1,491	53
3	220 to 240 V	2,528	62	2,237	55
4	220 to 240 V	3,371	64	2,983	57

Red

Light colour: red

Application example: offshore area or near ports

Size	Voltage	Without diffuser		With diffuser	
		Luminous flux [lm]	Luminaire efficacy [lm/W]	Luminous flux [lm]	Luminaire efficacy [lm/W]
1	24 to 48 V 110 to 240 V	537	51	475	45
4	220 to 240 V	2,386	57	2,112	50

Technical Data

Luminous flux decline

- during DC operation to 50% (only size 2 to 4)
- at ambient temperature

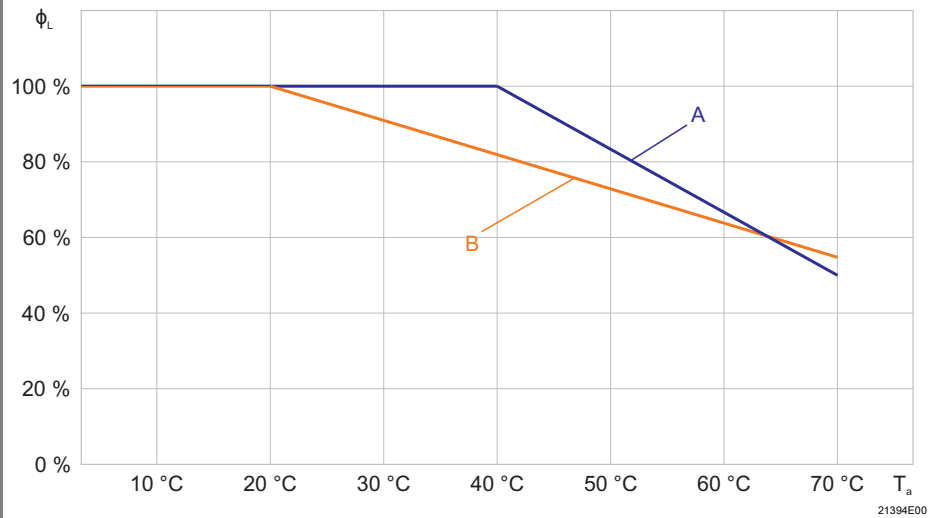

A: Size 1 (110 to 240 V)
B: Size 1 (12, 24 to 48 V)

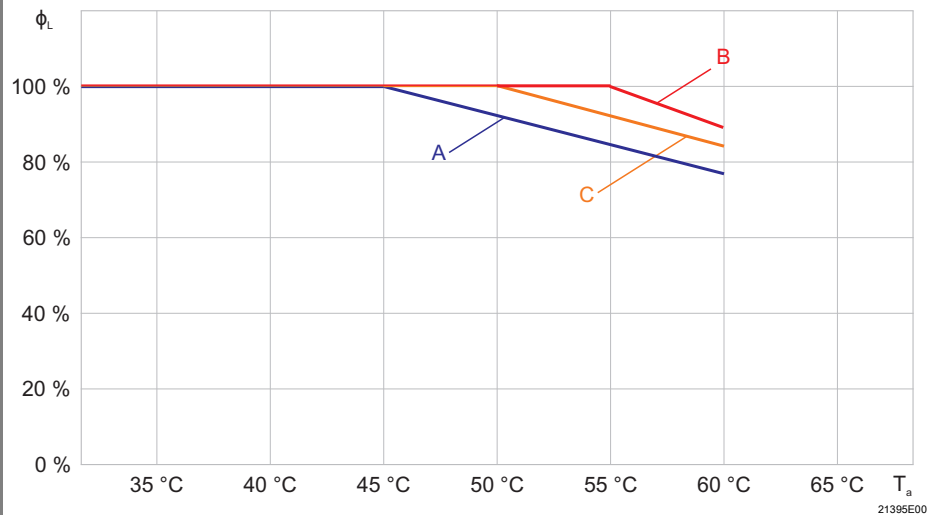

A: Size 2
B: Size 3
C: Size 4

Ambient conditions

Temperature class, max. surface temperature

Version	Temperature class	Surface temperature
6036/1...-0..-....-..	T4	100 °C
6036/1...-1..-....-..	T6	80 °C

Technical Data

Operating temperature range	Size 1:			
	Voltage range	T4 variant Mining variant	T6 variant	
	100 to 240 V AC/DC	-30 to +70 °C	-30 to +40 °C	
	24 to 48 V AC/DC	-40 to +70 °C	-40 to +40 °C	
	12 V DC	-40 to +40 °C	–	
	Size 2 to 4:			
	Cable	T4 variant	T6 variant	Mining variant
	H07RN-F; 2 x 2.5 mm ²	-55 to +60 °C	-55 to +45 °C	-40 to +60 °C
	H07RN8-F; 2 x 1.5 mm ²	-55 to +60 °C	-55 to +45 °C	-40 to +60 °C
	HXSLHXÖ; 2 x 1.5 mm ²	-40 to +60 °C	-40 to +45 °C	-40 to +60 °C
RCO 52261; 2 x 1.5 mm ²	-55 to +60 °C	-55 to +45 °C	-40 to +60 °C	
BFOU P5-P12; 2 x 1.5 mm ²	-52 to +60 °C	-52 to +45 °C	-40 to +60 °C	
(N)SSHÖU 1 kV; 2 x 1.5 mm ²	-45 to +60 °C	-45 to +45 °C	-40 to +60 °C	
RADOX, MFH-S B; 2 x 1.5 mm ² 3 x 1.5 mm ² 3 x 2.5 mm ²	-50 to +60 °C	-50 to +45 °C	-40 to +60 °C	
Storage	Data applies to fixed electric lines.			
	The luminaire must be switched on above -40 °C.			
	-40 to +70 °C -30 to +70 °C (size 1 variant 100 to 240 V AC/DC)			

Technical Data

Service life

LED

Variants with High-Power LED:

	$T_a \leq 25\text{ °C}$	$T_a \leq 45\text{ °C}$	$T_a \leq 60\text{ °C}$
L ₇₀ B ₁₀	100,000 h	90,000 h	80,000 h

Variants with Mid-Power LED:

	$T_a \leq 25\text{ °C}$	$T_a \leq 45\text{ °C}$	$T_a \leq 60\text{ °C}$
L ₉₀ B ₅₀	100,000 h	100,000 h	100,000 h

L_xB_y

At the end of the service life:

- Luminous flux decrease to "x" percent
- up to "y" percent of all light fittings fall below "x"

Control gear

	$T_a \leq 25\text{ °C}$	$T_a \leq 45\text{ °C}$	$T_a \leq 60\text{ °C}$
C ₁₀	100,000 h	90,000 h	80,000 h

C₁₀ = failure rate 10 %

Mechanical data

Degree of protection

IP66 / IP67
IP68 (10 m / 1 h)
acc. to IEC 60598

Protection class

II

Impact strength
(IK code)

IK10 (IEC 62262)

Material

Enclosure tube

Polycarbonate

Sealing cap

NBR / PVC (EPDM)

Technical Data

Mounting / Installation

Connection line

The connection line must be laid securely.**Designation**H07RN8-F, \varnothing 8.6 to 9.6 mm, 2 x 1.5 mm²**Application**

Standard
 Longitudinally
 watertight,
 environment with
 a very high level of
 humidity,
 rainwater retention
 basin,
 mixed water,
 groundwater,
 seawater,
 suitable for surface
 mining, Ex tested

HXSLHXÖ, \varnothing 7.0 to 7.6 mm, 2 x 1.5 mm²

Increased flame
 resistance,
 halogen-free,
 acid-resistant

RCO 52261, \varnothing 10 to 12 mm, 2 x 1.5 mm²

Special applications,
 shielded cable

BFOU P5-P12, \varnothing 12.2 to 13.8 mm, 2 x 1.5 mm²

Increased flame
 resistance, offshore,
 slurry, drilling and
 cleaning fluids

(N)SSHÖU 1 kV, \varnothing 8.7 to 9 mm, 2 x 1.5 mm²

Voltage-proof
 up to 1 kV, mining

RADOX, MFH-S B, \varnothing 6 to 7 mm, 2 x 1.5 mm²

Offshore, marine,
 halogen-free

Cable entry

CMP-20sA2F KLE MsNi M20 (installed ex-factory)

Mounting

Mounting options:

Pipe clamp: rubber coated, clamping range 48 to 53 mm

Double pipe
 clamp: made of plastic for mounting of pipes with a
 diameter of 45 to 55 mm
 (Screws and nuts made of stainless steel V2A)

For further technical data, see r-stahl.com.

6 Transport and storage

- Transport and store the device only in the original packaging.
- Store the device in a dry place (no condensation) and vibration-free.
- Do not drop the device.

7 Mounting and installation

	DANGER
	<p>Explosion hazard due to incorrect installation of the device! Non-compliance results in severe or fatal injuries.</p> <ul style="list-style-type: none"> • Carry out installation strictly according to the instructions and national safety and accident prevention regulations to maintain the explosion protection. • Select and install the electrical device so that explosion protection is not affected due to external influences, i.e. pressure conditions, chemical, mechanical, thermal and electric impact such as vibration, humidity and corrosion (see IEC/EN 60079-14). • The device must only be installed by trained qualified personnel who is familiar with the relevant standards.

7.1 Dimensions / fastening dimensions

Dimensional drawings (All dimensions in mm [inches]) – Subject to alterations

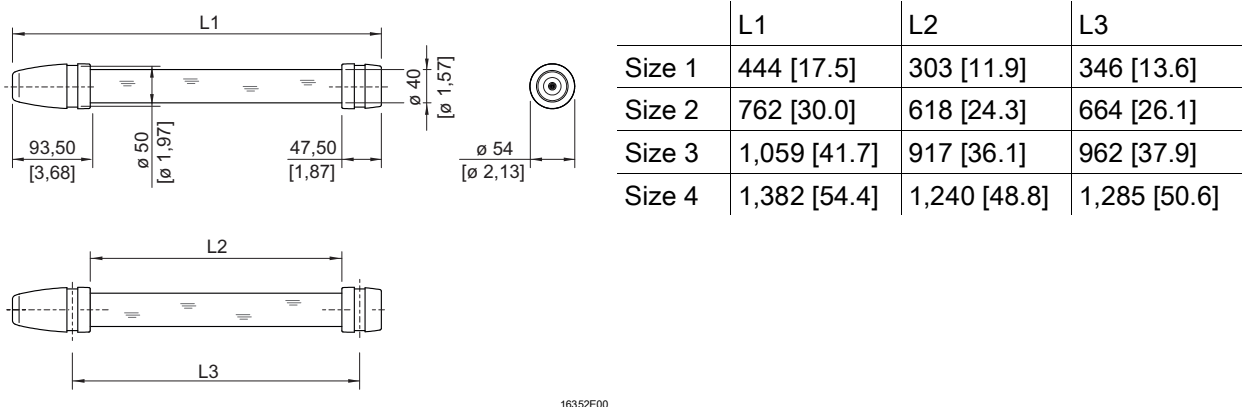





7.2 Removing protective foil

As standard, the luminaire is generally delivered with protective foil on the translucent cover. However, in some cases, it can be delivered without protective foil.

	DANGER
	<p>Explosion hazard due to electrostatic discharge! Non-compliance results in severe or fatal injuries.</p> <ul style="list-style-type: none"> • Only remove protective foil in safe areas.

- If protective foil is available:
 Remove protective foil prior to commissioning.

7.3 Mounting / dismantling, operating position

	<p style="text-align: center;">DANGER</p> <p>Explosion hazard due to electrostatic discharge Non-compliance results in severe or fatal injuries.</p> <p>Do not use the luminaire in strong charge generating environments!</p> <p>The following processes/activities should be avoided:</p> <ul style="list-style-type: none"> • accidental friction • particle currents
	<p style="text-align: center;">DANGER</p> <p>Explosion hazard due to sparking! Non-compliance results in severe or fatal injuries.</p> <ul style="list-style-type: none"> • Use the luminaire only with the two rubber caps installed ex-factory.
	<p style="text-align: center;">CAUTION</p> <p>Risk of damage to the eyes caused by optical radiation! Minor injuries are possible!</p> <ul style="list-style-type: none"> • Minimum distance of at least 0.7 m between the luminaire and the eye of the viewer for the version with blue LEDs.
<p style="text-align: center;">NOTICE</p> <p>The use in extremely humid environments may cause malfunctions or damage to the device. Non-compliance can result in material damage.</p> <ul style="list-style-type: none"> • Energise the light fitting > 2 hours per day. This will avoid moisture inside the light fitting and prevent premature failure of the electronic elements. 	
	<p>The light fitting is suitable for wall and ceiling mounting. Outdoors, the mounting position with cable outlet at top is not allowed.</p>

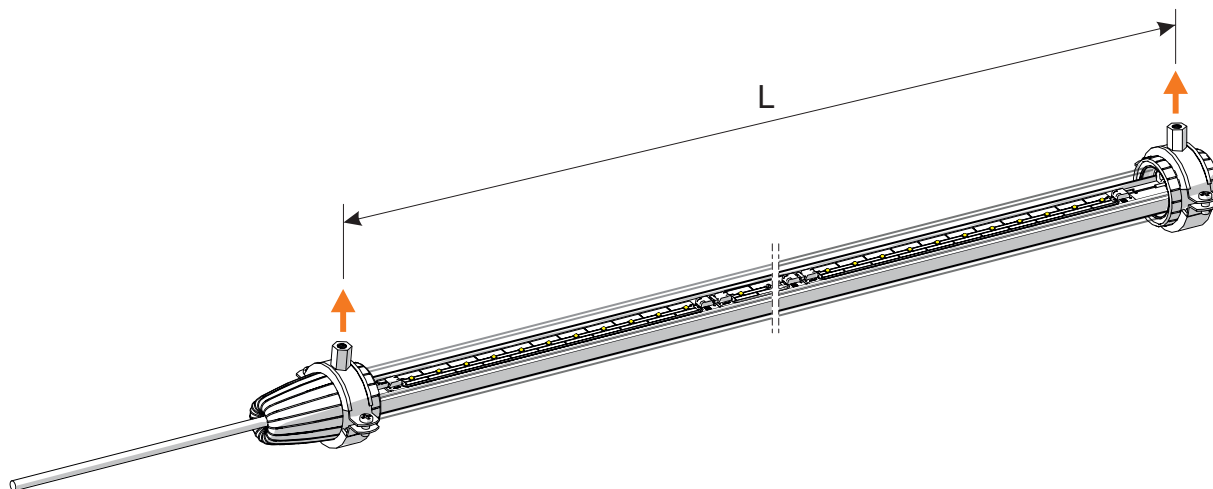

16362E00

Size	L in mm [inches]
1	346 ±2 [13.6 ±0.08]
2	664 ±2 [26.1 ±0.08]
3	962 ±2 [37.9 ±0.08]
4	1,285 ±2 [50.6 ±0.08]

- Attach suitable hanger bolts with M8 or M10 thread at a distance "L" depending on the version of luminaire.
- Screw the pipe clamps on the hanger bolts.
- Mount the tubular light fitting inside the pipe clamps.

7.4 Installation

7.4.1 Electrical connections

The light fitting is delivered with connection cable.



The connection to the power supply must be established using a terminal box or a plug.

7.4.2 Shortening the connection cable

The connection cable can be shortened in order to adapt the installation.

	DANGER
	<p>Explosion hazard if the electrical line is shortened too much! Non-compliance results in severe or fatal injuries.</p> <ul style="list-style-type: none"> • Do not shorten the cable connected ex-factory to a length of < 1 m.

8 Commissioning

	DANGER
	<p>Explosion hazard due to incorrect installation! Non-compliance results in severe or fatal injuries.</p> <ul style="list-style-type: none"> • Check the device for proper installation before commissioning. • Comply with national regulations.
	<p>The luminaire is delivered with a protection foil. Prior to commissioning, remove the foil completely.</p>

Before commissioning, ensure the following:

- Check the mounting and installation.
- Check the device for damage.
- Remove any foreign bodies.
- If necessary, clean the connection chamber.
- Check if all screws and nuts have been tightened firmly.

9 Maintenance, Overhaul, Repair

	CAUTION
	<p>Risk of electric shock or malfunction of the device due to unauthorized work! Non-compliance can result in light injuries!</p> <ul style="list-style-type: none"> • Before carrying out work on the device, switch off voltage supply. • Work performed on the device must only be carried out by authorized and appropriately trained qualified electricians.

9.1 Maintenance

- Consult the relevant national regulations to determine the type and extent of inspections.
- Adapt inspection intervals to the operating conditions.
- Perform maintenance and repair work in accordance with IEC 60079-17 and IEC 60079-19.

	CAUTION
	<p>Danger of electric shock due to energised parts! Non-compliance can result in minor injuries!</p> <ul style="list-style-type: none"> • All connections must be disconnected from the power supply. • Secure the connections against unauthorized switching.

	<p>Observe the relevant national regulations in the country of use.</p>
---	---

At a minimum, check the following points during maintenance work on the device:

- Whether the device has cracks or other visible signs of damage
- Whether the device is clean inside and out
- Compliance with the permissible temperatures (in accordance with EN 60079)
- Whether the cables and electrical lines show signs of ageing and damage
- Whether the device is used as intended and functions properly.

9.2 Repair

	DANGER
	<p>Explosion hazard due to improper repair! Non-compliance results in severe or fatal injuries.</p> <ul style="list-style-type: none"> • Repair work on the devices must be performed only by R. STAHL Schaltgeräte GmbH.

9.3 Returning the device

- Only return or package the devices after consulting R. STAHL!
Contact the responsible representative from R. STAHL.

R. STAHL's customer service is available to handle returns if repair or service is required.

- Contact customer service personally.

or

- Go to the r-stahl.com website.
- Under "Support" > "RMA" > select "RMA-REQUEST".
- Fill out the form and send it.
You will automatically receive an RMA form via email. Please print this file off.
- Send the device along with the RMA form in the packaging to
R. STAHL Schaltgeräte GmbH (refer to chapter 1.1 for the address).

10 Cleaning

- To avoid electrostatic charging, the devices located in potentially explosive areas may only be cleaned using a damp cloth.
- When cleaning with a damp cloth, use water or mild, non-abrasive, non-scratching cleaning agents.
- Do not use aggressive detergents or solvents.

11 Disposal

- Observe national and local regulations and statutory regulation regarding disposal.
- Separate materials when sending it for recycling.
- Ensure environmentally friendly disposal of all components according to the statutory regulations.

12 Accessories and Spare parts

NOTICE

Malfunction or damage to the device due to the use of non-original components.
Non-compliance can result in material damage.

- Use only original accessories and spare parts from R. STAHL Schaltgeräte GmbH.



For accessories and spare parts, see data sheet on our homepage
r-stahl.com.

EU-Konformitätserklärung
EU Declaration of Conformity
Déclaration de Conformité UE





R. STAHL Schaltgeräte GmbH • Am Bahnhof 30 • 74638 Waldenburg, Germany
 erklärt in alleiniger Verantwortung, *declares in its sole responsibility, déclare sous sa seule responsabilité,*

dass das Produkt: **Rohrleuchte**
that the product: *Tubular light fitting*
que le produit: *Appareil d'éclairage tubulaire*

Typ(en), type(s), type(s): **6036/.....-.....-.....**

mit den Anforderungen der folgenden Richtlinien und Normen übereinstimmt.
is in conformity with the requirements of the following directives and standards.
est conforme aux exigences des directives et des normes suivantes.

Richtlinie(n) / Directive(s) / Directive(s)		Norm(en) / Standard(s) / Norme(s)
2014/34/EU 2014/34/EU 2014/34/UE	ATEX-Richtlinie <i>ATEX Directive</i> <i>Directive ATEX</i>	EN 60079-0:2012 + A11:2013 EN 60079-1:2014 EN 60079-28:2015 EN 60079-31:2014
Kennzeichnung, marking, marquage:		 II 2 G Ex db op is IIC T6/T4 Gb II 2 D Ex tb IIIC T80 °C/T100 °C Db I M2 Ex db op is I Mb  0158
EU-Baumusterprüfbescheinigung: <i>EU Type Examination Certificate:</i> <i>Attestation d'examen UE de type:</i>		EPS 13 ATEX 1597 (Bureau Veritas Consumer Products Services Germany GmbH, Businesspark A96, 86842 Tuerkheim, Gemany, NB 2004)
Produktnormen nach Niederspannungsrichtlinie: <i>Product standards according to Low Voltage Directive:</i> <i>Normes des produit pour la Directive Basse Tension:</i>		EN 60598-1:2015 EN 60598-2-22:2014 EN 62471:2008 EN 62493:2010
2014/30/EU 2014/30/EU 2014/30/UE	EMV-Richtlinie <i>EMC Directive</i> <i>Directive CEM</i>	EN 61547:2009 EN 55015:2013 EN 61000-3-2:2014 EN 61000-3-3:2013
2011/65/EU 2011/65/EU 2011/65/UE	RoHS-Richtlinie <i>RoHS Directive</i> <i>Directive RoHS</i>	EN 50581:2012

Waldenburg, 2017-05-29

Ort und Datum
Place and date
Lieu et date

i.V.

Dr. A. Kaufmann
Leiter BU Leuchten & Signalgeräte
Head of BU Lightings & Signalling
Directeur BU Eclairage & Appareils de signalisation

i.V.

J. Freimüller
Leiter Qualitätsmanagement
Director Quality Management
Directeur Assurance de Qualité