

Emergency Luminaire with LED

Series EXLUX 6009/1 Version IIC



www.stahl.de



18327E00

- > For use in hazardous areas with gas group IIC
- > Emergency luminaire for wall, ceiling, pendant or pole installation
- > Latest LED technology with a high luminous efficacy and a long service life
- > Central locking system
- > Weekly functional test
- > Annually rated operating time test

E2



The luminaires of the series **EXLUX 6009 LED** can be used for safety lighting

Zone	ATEX / IECEx					
	0	1	2	20	21	22
For use in		x	x		x	x

Explosion Protection

Global (IECEx)	
Gas and dust	IECEx IBE 16.0038 Ex db eb mb op is IIC T4 Gb Ex tb op is IIIC T100°C Db
Europe (ATEX)	
Gas and dust	IBExU16ATEX1199 ⊕ II 2 G Ex db eb mb op is IIC T4 Gb ⊕ II 2 D Ex tb op is IIIC T100°C Db
Certifications and certificates	
Certificates	IECEx, ATEX

WebCode 6009C

Emergency Luminaire with LED

Series EXLUX 6009/1 Version IIC

Selection Table

Version	Colour temperature	CRI	Power consumption	Cable entry	Order number	Art. no.	Weight
							kg
Emergency luminaire with LED, Series EXLUX 6009/1, gas group IIC	5,000 K	≥ 80	28 W	3x M25 Plastic	6009/1282-171-7611-131-00	256334	6.780
				3x M20 Metal	6009/1282-171-7611-232-00	256280	6.830
			52 W	3x M25 Plastic	6009/1482-171-7611-131-00	256332	9.350
				3x M20 Metal	6009/1482-171-7611-232-00	256278	9.350

Order Number Supplement

Through wiring	with 6 conductors	6.09/.....6.....
	without	6.09/.....0.....
Connection terminal	Spring clamp terminal type WAGO 0.75 ... 4 mm ²	6.09/.....1-.....
	Screw-type terminal type STAHL 1.5 ... 6 mm ²	6.09/.....2-.....
Cable glands	M25 hole	6.09/.....-1....
	M20 hole	6.09/.....-2....
	1/2" hole	6.09/.....-3....
	3/4" hole	6.09/.....-4....
	Number of holes = 1	6.09/.....-1...-
	Number of holes = 2	6.09/.....-2...-
	Number of holes = 3	6.09/.....-3...-
	Number of holes = 4	6.09/.....-4...-
	Insert made of plastic	6.09/.....-1...-
	Insert made of stainless steel	6.09/.....-2...-
Rated operating time test	with	6.09/.....-7-.....
	without	6.09/.....-8-.....

Note

The light fittings are delivered without mounting material. These accessories must be ordered separately!

Emergency Luminaire with LED

Series EXLUX 6009/1 Version IIC



Technical Data

Electrical data

Control gear

	AC: 110 ... 240 V \pm 10 %; 50 ... 60 Hz			
	6009/12...-1...-...-...-...		6009/14...-1...-...-...-...	
Power consumption [W]	28		52	
Voltage [V]	230	110	230	110
Frequency [Hz]	50	60	50	60
Power factor	\geq 0.90	\geq 0.98	\geq 0.95	\geq 0.99
THD [%]	\leq 12.5	\leq 12.5	\leq 7	\leq 8
Rated operational current [A]				
LEDs off, battery conservation mode	typ. 0.05	typ. 0.05	typ. 0.05	typ. 0.05
LEDs on, battery conservation mode	typ. 0.14	typ. 0.26	typ. 0.24	typ. 0.48
LEDs off, battery charging mode	typ. 0.06	typ. 0.08	typ. 0.06	typ. 0.08
LEDs on, battery charging mode	typ. 0.14	typ. 0.28	typ. 0.24	typ. 0.50

Inrush current

$I_{peak} = 63$ A; $\Delta t = 115$ μ s
 maximum number of luminaires per miniature circuit breaker at 230 V:

Type	10 A	16 A	20 A	25 A
B	7	12	15	18
C	12	20	25	31
K	25	40	50	62

Luminous characteristics

	6009/12...-1...-...-...-00	6009/14...-1...-...-...-00	6009/12...-1...-...-...-01	6009/14...-1...-...-...-01
Power consumption [W]	28	52	28	52
Colour rendering [CRI]	\geq 80	\geq 80	\geq 70	\geq 70
Colour temperature [K]	5,000	5,000	5,700	5,700
without diffuser				
Luminous flux [lm]	typ. 2,850	typ. 5,700	typ. 3,150	typ. 6,300
Luminaire efficiency [lm/W]	typ. 102	typ. 110	typ. 113	typ. 121
with diffuser				
Luminous flux [lm]	typ. 2,350	typ. 4,700	typ. 2,600	typ. 5,200
Luminaire efficiency [lm/W]	typ. 84	typ. 90	typ. 93	typ. 100

Values apply to $T_a = +25$ °C.

E2

Emergency Luminaire with LED

Series EXLUX 6009/1 Version IIC

Technical Data

Service life

Service life

	$T_a \leq 25\text{ °C}$	$T_a \leq 45\text{ °C}$	$T_a \leq 60\text{ °C}$
L ₇₀ B ₁₀ C ₁₀	100,000 h	90,000 h	50,000 h

L_xB_yC_z

At the end of the Service Life:

- Luminous flux decrease to "x" percent
- max. "y" percent of all the light fittings fall below "x"
- max. "z" percent of all the light fittings break down completely

Ambient conditions

Ambient temperature

-30 ... +60 °C (1, 2)	without through wiring
-30 ... +55 °C (1, 2)	with through wiring; I _N ≤ 10 A
-30 ... +50 °C (1)	with through wiring; I _N ≤ 16 A

(1) Rated operating time during emergency light operation

is guaranteed within an ambient temperature range of -5 ... +50 °C. This also applies to charging and discharging of the battery. The rated operating time might be reduced if used outside this temperature range.

(2) Battery service life

is guaranteed within an ambient temperature range of -30 ... +50 °C according to IEC/EN 60598-2-22.

Mechanical data

Degree of protection

IP66 / IP67 (IEC 60598)

Protection class

I (with internal PE connection)

Impact strength (IK code)

IK10 (IEC 62262)

Material

Enclosure

Enclosure

Polyester resin, glass fibre-reinforced

Colour

colour grey, similar to RAL 7035

Translucent cover

Polycarbonate

Seal

Silicone foam gasket in the lamp cover

Luminaire locking

Central locking which can be opened/closed using a socket key M8 / wrench size 13, hinged lamp cover

Mounting / Installation

Cable glands

Standard luminaire

Plastic: 2 x M25 x 1.5 cable entries 8161 and
2 x M25 x 1.5 stopping plugs 8290 (enclosed)

Metal: 2 x metal plates M20 x 1.5 connected by means of PE for metal cable entries
Attention: cable entries must be ordered separately

Special: max. 4 drilled holes for M20, M25, NPSM ½"
max. 2 drilled holes for NPT ¾"

Metal cable glands: M20 x 1.5, M25 x 1.5; earthing of the metal cable entries by means of metal plates

Connection

Standard: Spring clamp terminals
6-pole: L1, L2, L3, L', N, PE
Clamping range: 1 x 0.75 ... 4 mm² (solid / finely stranded)
(2 free clamping units per pole available)

Special: Terminal block with covering
6-pole: L1, L2, L3, L', N, PE
Clamping range: 2 x 1.5 ... 6 mm² (solid); 2 x 1.5 ... 4 mm² (finely and extra finely stranded)

Emergency Luminaire with LED

Series EXLUX 6009/1 Version IIC



Technical Data

Through wiring	Through wiring	Standard luminaire Luminaires are equipped with internal through wiring. Ingoing and outgoing leads can be connected to the opposite sides. Terminals: see techn. data Wiring cross section: 2.5 mm ² for max. 16 A.
	without	Optional On the connection side, there are 2 cable entries M25 x 1.5 for ingoing and outgoing wiring of the connection line (ingoing and outgoing leads on one side).
Assembly	Standard luminaire	
	Standard:	2 x M8 insert nuts in the enclosure
	Special:	Mounting grooves in the enclosure for use of fastening and ceiling rails for variable luminaire mounting (variable mounting distances for luminaires L = 700 mm: 320 ... 480 mm; L = 1310 mm; 670 ... 930 mm)

Control gear

Emergency light mode	In case of power failure the LEDs are supplied by the battery		
Rated operating time	at optimal ambient temperature of the battery:		
	Battery capacity	Operating time of emergency light	Emergency light output
			28 W 52 W
	7 Ah	1.5 h	58 % 31 %
		3.0 h	30 % 21 %
Switchover voltage	from mains to battery operation for $U < 0.83 \times U_N$ from battery to mains operation for $U > 0.88 \times U_N$		

Battery set

Version	Gas-tight NiCd battery
Operating voltage	6 V
Capacity	7 Ah
Replacing the battery set	When opening the battery enclosure, the connection between the battery and the emergency light electronics is disconnected by means of a switch. The battery set can be replaced after disconnecting the plug-in contacts.

E2

Emergency Luminaire with LED

Series EXLUX 6009/1 Version IIC

Light Distribution Curves

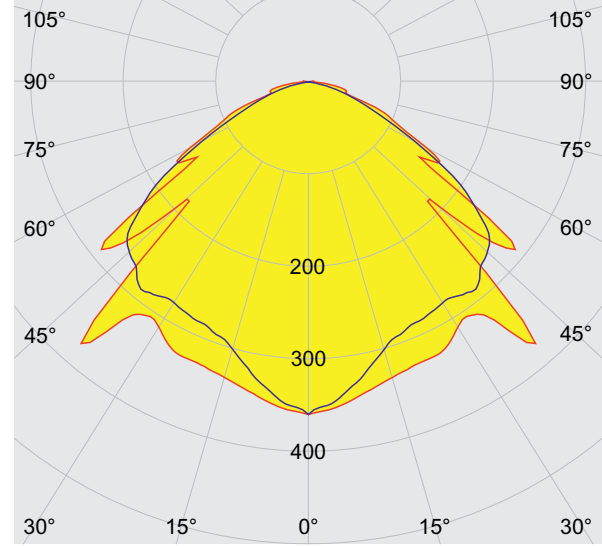

cd/klm $\eta = 100\%$
 — C0 - C180 — C90 - C270

18729E00

28 W without diffuser

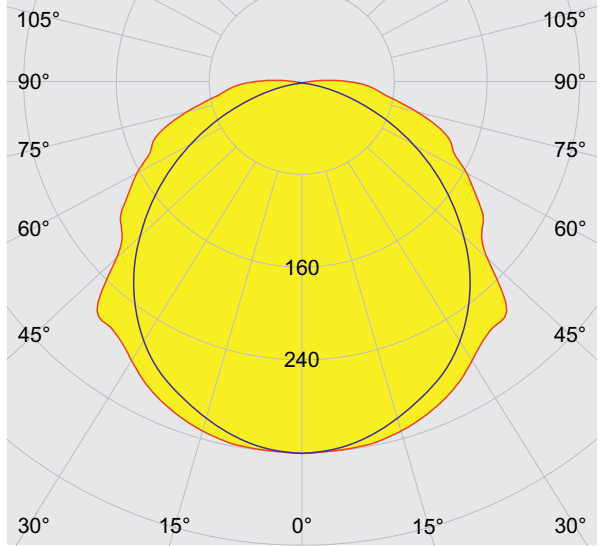

cd/klm $\eta = 100\%$
 — C0 - C180 — C90 - C270

18728E00

28 W with diffuser

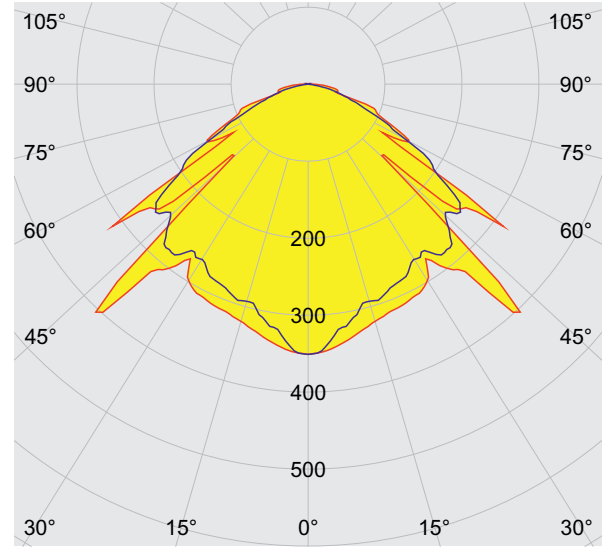

cd/klm $\eta = 100\%$
 — C0 - C180 — C90 - C270

18731E00

52 W without diffuser

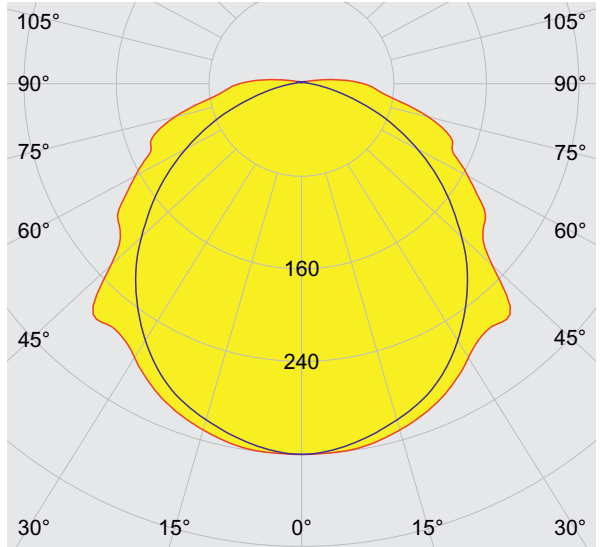

cd/klm $\eta = 100\%$
 — C0 - C180 — C90 - C270

18730E00







52 W with diffuser

Emergency Luminaire with LED

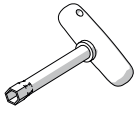
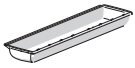
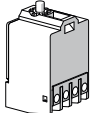
Series EXLUX 6009/1 Version IIC

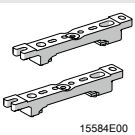
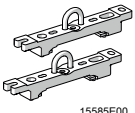
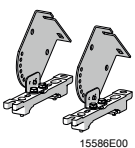
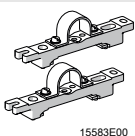

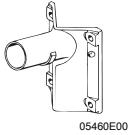
Accessories and Spare Parts

Designation	Figure	Description	Art. no.	Weight kg
Socket key	 15507E00	M8 / wrench size 13; to open/close the central locking	222430	0.210
Lamp cover		for luminaire L=700	222427	0.639
		for luminaire L=1310	222428	1.149
		for luminaire L=700 (resistant to aromatic substances)	256534	0.639
		for luminaire L=1310 (resistant to aromatic substances)	256535	1.149
Switch	 10809E00	Switching element 8080/1-3-L, 2 normally closed contacts	132527	0.026
Breathing gland	 05703E00	M25 x 1.5 in order to avoid condensate formation for 6009/1	115738	0.017
Ring bolt	 05378E00	M8, direct mounting in insert nuts, 1 pair	115736	0.112
Mounting rail	 15584E00	for a variable mounting distance	1 pair 222826	0.300
Mounting bracket	 15585E00	mounting clamp mounted on a mounting rail for a variable mounting distance	1 pair 222456	0.400
Ceiling and wall-mounting bracket	 15586E00	mounted on a mounting rail for a variable mounting distance; Material: stainless steel Lamp can be swiveled in steps of 15°	1 pair 222827	1.200
Pipe clamp	 15583E00	R 1 1/2"	222459	1.200
		R 1 1/4"	222458	0.900
		R 2"	222460	0.750
		with mounting rail for a variable mounting distance; Material: stainless steel	1 pair	
Pole mounting sleeve	 16985E00	for the subsequent mounting on lights 18 W and 36 W, completely with assembly parts	227512	3.200
Bracket for wall mounting with tube	 05460E00	for side entry lamp; with tube, length 400 mm, \varnothing 42 mm	108947	2.480
Battery set	 16332E00	Battery cover with built-in battery. Gas-tight NiCd battery; 7 Ah / 6 V	223532	1.195

E2

Emergency Luminaire with LED

Series EXLUX 6009/1 Version IIC

Dimensional Drawings (All dimensions in mm [inches]) - Subject to alterations

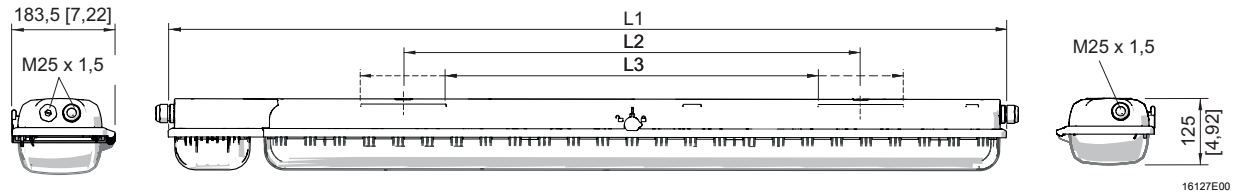

Dimensions	Luminaire	
	28 W	52 W
L1	857 [33.74]	1467 [57.76]
L2 ¹⁾	400 [15.75]	800 [31.50]
L3 ²⁾	320 ... 480 [12.60 ... 18.90]	670 ... 930 [26.38 ... 36.61]

- ¹⁾ fixed mounting distance
- ²⁾ variable mounting distance

EXLUX 6009/1

Dimensional drawings for assembly parts and accessories (all dimensions in mm [inches]) – Subject to alterations

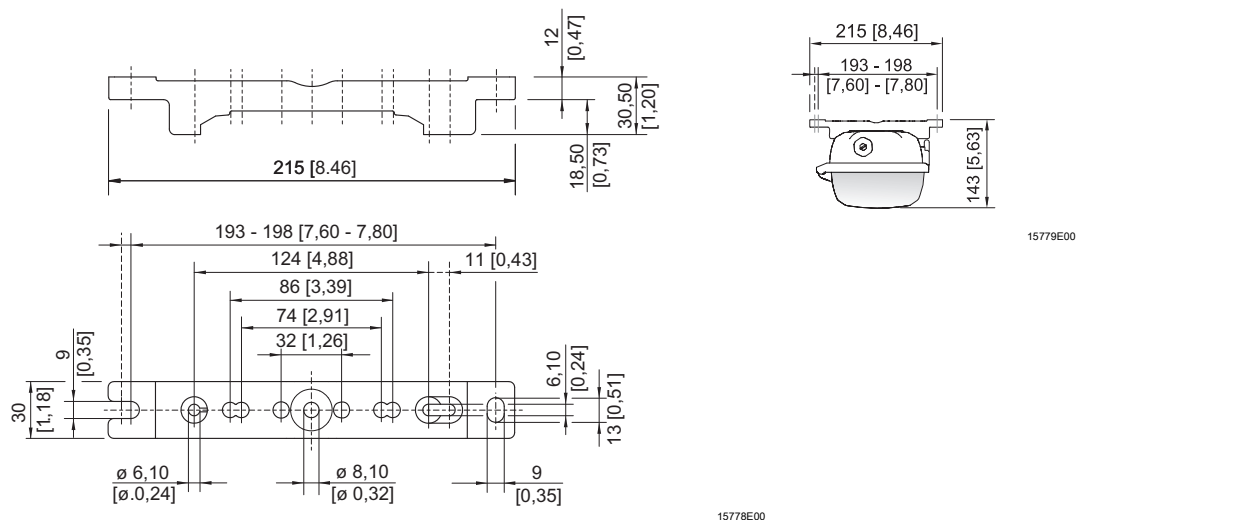

Mounting rail

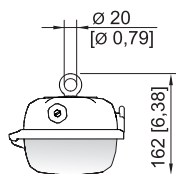

15782E00

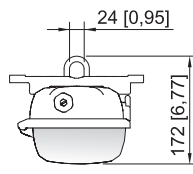

15781E00

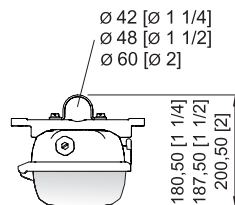

15783E00

Ring bolt fitted in insert nut of the luminaire

Mounting bracket fitted in mounting rail

Pipe clamp fitted in mounting rail

Emergency Luminaire with LED

Series EXLUX 6009/1 Version IIC



Dimensional drawings for assembly parts and accessories (all dimensions in mm [inches]) – Subject to alterations

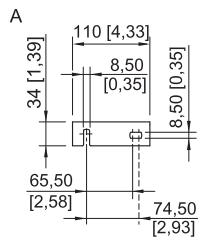
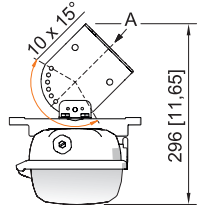

15780E00

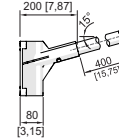
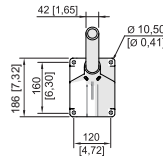

03257E00

Wall mounting bracket fitted in mounting rail

Bracket for wall mounting with pipe section

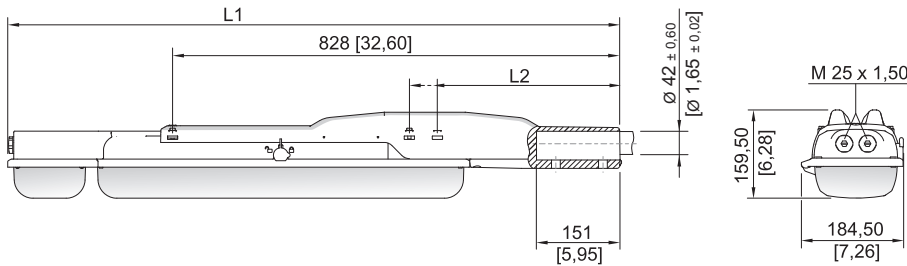

17756E00

Dimensions	Luminaire	
	28 W	52 W
L1	1135 [44.69]	1744 [68.66]
L2	390 [15.35]	338 [13.31]

Linear luminaire EXLUX with pole mounting sleeve

We reserve the right to make alterations to the technical data, dimensions, weights, designs and products available without notice. The illustrations cannot be considered binding.