



Operating Instruction



Device platform RAPTOR

ET-208

SERIES 200 Operator Interfaces



THE STRONGEST LINK.

HW-Rev. ET-208-TX-*-DC:	01.00.15
HW-Rev. ET-208-TX-*-AC:	01.00.25
HW-Rev. ET-208-TX-W00-DC-GLN:	01.00.32
HW-Rev. ET-208-TX-W00-AC-GLN:	01.00.40

Operating instruction version:	01.00.31
Issue:	03.02.2023

Order number:	297622
---------------	--------

Disclaimer

Publisher and copyright holder:

R. STAHL HMI Systems GmbH
Adolf-Grimme-Allee 8
D 50829 Köln

Telephone:	(Sales Support)	+49 221 768 06	- 1200
	(Technical Support)		- 5000
Fax:			- 4200
E-mail:	(Sales Support)	sales.dehm@r-stahl.com	
	(Technical Support)	support.dehm@r-stahl.com	

- All rights reserved.
- This document may not be reproduced in whole or in part except with the written consent of the publisher.
- Subject to alterations.

Any warranty claims are limited to the right to demand amendments. Liability for any damage that might result from the contents of these instructions or all other documentation is limited to clear cases of premeditation.

We reserve the right to change our products and their specifications at any time, provided it is in the interest of technical progress. The information in the current manual (online or on CD / DVD / USB stick) or in the operating instructions included in the delivery applies.

Trademarks

The terms and names used in this document are registered trademarks and / or products of the companies in question.

Copyright © 2023 by R. STAHL HMI Systems GmbH. Subject to alterations.

Specific markings

The markings in these operating instructions refer to specific features that must be noted.

In detail, these are:

 DANGER	This sign alerts users to hazards that will result in death or serious injury if ignored !
-------------------------------------------------------------------------------------------------	---------------------------------------------------------------------------------------------------

 WARNING	This sign alerts users to hazards that may result in death or serious injury if ignored !
--------------------------------------------------------------------------------------------------	--------------------------------------------------------------------------------------------------

 CAUTION	This sign alerts users to hazards that may damage machinery or equipment or result in injury if ignored !
--------------------------------------------------------------------------------------------------	-----------------------------------------------------------------------------------------------------------

 ATTENTION	Information highlighted by this symbol indicates measures for the prevention of damage to machinery or equipment !
----------------------------------------------------------------------------------------------------	--------------------------------------------------------------------------------------------------------------------

 NOTICE	Information highlighted by this symbol (with and without lettering) indicates important information of which particular note should be taken !
---------------------------------------------------------------------------------------------------	------------------------------------------------------------------------------------------------------------------------------------------------

 DOCUMENTATION	Information highlighted by this symbol (with and without lettering) refers to a different chapter or section in this manual or other documentation or a web-page !
----------------------------------------------------------------------------------------------------------	--------------------------------------------------------------------------------------------------------------------------------------------------------------------

Warnings

	<p>Caution !</p> <p>In ambient temperatures exceeding +45 °C the surface of the devices may heat up. Caution when touching !</p>
-------------------------------------------------------------------------------------	----------------------------------------------------------------------------------------------------------------------------------

Table of contents

	Description	Page
	Disclaimer	2
	Specific markings	3
	Warnings	3
	Table of contents	4
1	Preface	6
2	Device function	6
2.1	Image sticking	6
2.2	Overview hardware revision ET-208	7
3	Technical data	8
3.1	Heater operation	10
4	Conformity to standards	11
5	Certificates	12
	Europe (CE / ATEX)	12
	Global (IECEx)	12
	Russia (EAC)	12
	USA (NEC)	12
	Canada (CEC)	12
	China (CCC / CNEX)	12
	Korea (KCC / KCS)	12
	Japan (JPNEEx)	12
	India (PESO / BIS)	12
	Marine certification (DNV)	12
5.1	FSB notification	12
6	Marking	13
7	Power supply	14
7.1	ET-208 Operator Interfaces	14
7.1.1	Terminals	14
7.1.1.1	Tightening torques	14
8	Permitted maximum values	15
8.1	External, non-intrinsically safe circuits	15
8.2	External intrinsically safe circuits	16
9	Type code	16
10	Safety Advice	17
10.1	Installation and operation	17
10.2	Special conditions	18
10.3	Industrial Security	18
11	Installation	19
11.1	General information	19
11.2	ET-208	19
11.2.1	Cable glands	19
11.2.2	Ingress Protection	20
11.2.2.1	IP54	20
11.2.2.2	IP65	20
11.2.2.3	IP66, IP69	20

11.2.3	HMI installation in enclosures with degree of protection "e" or "t"	20
11.2.4	Capacitive touch screen	21
12	Assembly and disassembly	22
12.1	General information	22
12.2	Cut-out ET-208	22
12.3	Mounting ET-208	22
12.4	Views	23
13	Operation	23
13.1	General information	23
13.2	Connection Overview	24
13.2.1	Connection details terminals	25
13.2.1.1	Ex e compartment	25
13.2.1.2	I.S. compartment	26
13.3	LEDs	26
14	Maintenance, service	27
14.1	Damaged sealing	27
14.2	Repair	27
14.3	Servicing	28
14.4	Saving data with ET-208	28
14.5	Time function	28
15	Troubleshooting	28
15.1	Repairs / hazardous substances	28
16	Disposal / Restricted substances	29
16.1	Declaration of substances and restricted substances	29
16.1.1	Declarable substance groups	29
16.1.2	RoHS directive 2011/65/EC	29
16.1.3	China RoHS labelling	29
16.1.4	IMO Resolution MEPC.269(68)	29
17	General information	30
17.1	Touch driver	30
18	Defective pixels	30
18.1	Terminology	30
18.2	Display specification	31
19	Optical acceptance of surfaces	32
19.1	Optical acceptance glass	32
19.2	Optical acceptance printing	33
19.3	Optical acceptance, other surfaces	33
20	Control Drawing	35
20.1	USA / Canada UL	35
21	Declaration of conformity	37
21.1	EC	37
21.2	EAC	38
21.3	CCC	42
21.3.1	English version	42
21.3.2	Chinese version	47
22	Release notes	52

1 Preface

These Operating Instructions contain all aspects relevant to explosion protection for the ET-208 units (SERIES 200 operator interfaces). They also contain information on the connection and installation (etc.) of these devices.

 NOTICE	All data relevant to explosion protection from the EC-type examination certificate were copied into these operating instructions.
	For the correct operation of all associated components please note, in addition to these operating instructions, all other operating instructions enclosed in this delivery as well as the operating instructions of the additional equipment to be connected !

 DOCUMENTATION	The certificates for the ET-208 devices are compiled in the document entitled CE_ET-208, which is stored on the CD / DVD / USB stick included in the delivery. You can also find this document online at r-stahl.com or request a copy from R. STAHL HMI Systems GmbH.
--------------------------------------------------------------------------------------------------------	---------------------------------------------------------------------------------------------------------------------------------------------------------------------------------------------------------------------------------------------------------------------------------------------------------

2 Device function

The ET-208 Operator Interfaces are explosion-protected equipment for installation in hazardous areas and can be operated in zones 1, 2, 21 and 22 according to ATEX Directive. The devices may be fitted in control cabinets, panels etc. or in field enclosures. They fit the cut-outs made for units of the FALCON SERIES.

The ET-208 operator interface is ideal for machine-oriented operations and visualisation (e.g. stirring units, compressors) and for installation on oil-rigs and tank farms. Its innovative product concept makes the ET-208 highly robust, seawater-proof, with IP66 / IP69 at the front and universally installable in temperatures ranging from -40 °C to +65 °C [-40 °F up to +149 °F]. The luminous 7" wide screen display shows processes with great contrast and easily legible in brilliant colours. For project engineering, the ET-208 can be configured with our proprietary, affordable SPSPlusWIN software and Windows Embedded Compact 7. For the integration of third-party software a version with the WEC7 open operating system is available. All major communication interfaces are available: industrial Ethernet as well as serial interfaces (RS-422 / RS-485).

2.1 Image sticking

Continuous displaying fixed pattern may include image sticking. It's recommended to use screen saver or moving content periodically if fixed pattern is displayed on the screen.

2.2 Overview hardware revision ET-208

HW-Rev.	Device type	Technical changing	Changing date hardware	OI version	OI date
01.00.10	ET-208-TX-W00-DC-GL	Approval 208, DC version	28.04.2015	01.00.02	11.05.2015
01.00.11		Internal changes	29.10.2015	01.00.04	10.11.2015
01.00.12		Internal changes	04.08.2017	01.00.17	18.09.2018
01.00.13		Approval KGS / KCC (Korea)	-	01.00.21	10.07.2019
		Approval JPNEEx (Japan)	09.01.2020	01.00.23	31.01.2020
01.00.14		Approval USA / Canada UL (terminals Phoenix)	30.06.2020	01.00.24	12.08.2020
01.00.15		Approval BIS (India)	14.09.2021	01.00.29	14.10.2021
01.00.20	ET-208-TX-W00-AC-GL	Approval 208, AC version	28.04.2015	01.00.02	11.05.2015
01.00.21		Internal changes	29.10.2015	01.00.04	10.11.2015
01.00.22		Internal changes	04.08.2017	01.00.17	18.09.2018
01.00.23		Approval KGS / KCC (Korea)	-	01.00.21	10.07.2019
		Approval JPNEEx (Japan)	09.01.2020	01.00.23	31.01.2020
		Approval DNV / GL	-	01.00.24	12.08.2020
01.00.24		Approval USA / Canada UL	09.10.2020	01.00.26	14.10.2020
01.00.25	Approval BIS (India)	14.09.2021	01.00.29	14.10.2021	
01.00.30	ET-208-TX-W00-DC-GLN	Approval USA / Canada UL (terminals WAGO) front plate neutral	10.01.2020	01.00.23	31.01.2020
01.00.31		Terminals Phoenix	10.08.2020	01.00.24	12.08.2020
01.00.32		Renew CCC / CNEX	09.10.2020	01.00.26	14.10.2020
01.00.40	ET-208-TX-W00-AC-GLN	Approval USA / Canada UL (terminals Phoenix)	30.06.2020	01.00.24	12.08.2020

3 Technical data

Function / Equipment	ET-208					
Picture						
Display version	TFT Color display					
Display version 2	16.2 million colours					
Display size inch	7					
Display size centimetres	18					
Display resolution	WVGA					
Total pixels	800 x 480					
Display brightness	500 cd/m ²					
Display contrast	600:1					
Touchscreen	yes, glass touch					
Touchscreen technology	projected, capacitive (PCAP)					
Touchscreen activation	no activation pressure necessary					
Touchscreen input method	Finger, thin gloved finger or special gloves, conductive stylus					
Touchscreen durability	very good					
Touchscreen scratch hardness MoHS	6					
Touchscreen scratch hardness pencil hardness test ISO 15184	9H					
Touchscreen transmissivity / optics	very good					
Touchscreen surface contaminants	Unaffected (but can be affected by conductive fluids (e.g. saltwater))					
Touchscreen abrasive resistance	no visible abrasion by rubber or finger					
Backlight	LED background lighting					
Service life backlight at +25 °C [+77 °F]	50,000 h					
Function keys at display	Optionally via key matrix, freely configurable up to 4 x 8 keys					
Power supply	in the Ex e terminal compartment					
Connections	via screw terminals, 2.5 mm ² green					
Voltage supply						
Version DC						
Rated Voltage	24 VDC					
Input Voltage Range	20.4 – 28.8 VDC					
Version AC						
Rated Voltage Range	115 - 230 VAC					
Input Voltage Range	85 - 253 VAC					
Rated Frequency Range	48 - 62 Hz					
Max. power consumption [mA] at	24 VDC	85 VAC	115 VAC	230 VAC	250 VAC	
Normal operation	475	168	131	84	82	
Operation with heating	890	373	280	162	152	
Power						
Normal operation	11.4 W	P = 10.7 W S = 14.2 VA cos φ = 0.75	P = 10.9 W S = 15 VA cos φ = 0.72	P = 12.5 W S = 19.4 VA cos φ = 0.64	P = 12.8 W S = 20.7 VA cos φ = 0.62	
Operation with heating	21.4 W	P = 25.2 W S = 31.2 VA cos φ = 0.8	P = 24.8 W S = 32 VA cos φ = 0.77	P = 26 W S = 37.3 VA cos φ = 0.69	P = 26.2 W S = 38.2 VA cos φ = 0.68	
Max. operating voltage U _m	253 VAC					
Protection fuse internal	1.6 A					
Protection fuse external	1.25 A					
Interfaces (part 1)	in the Ex e terminal compartment					
Connections	via screw terminals, 2.5 mm ² green					
Ethernet *						
Copper (TX)	10/100Base-TX, 10/100 Mbit/s					
USB1 *	as host or device, USB 2.0, 480 Mbit/s (Engineering port)					
Serial COM1	RS-422, RS-485 (keyed, keying by application)					
Readers COM2	RS-422, RS-485, connection for Barcode scanner or readers (via optional supply VM125-ex)					
Fieldbus	MPI with MPI Box SSW7-RK512-RS-422					

Interfaces (part 2)	in the I.S. terminal compartment:	
Connections	via screw terminals, 1.5 mm ² green	
USB2 *	as host (terminal or USB socket type A), USB 2.0, 12 Mbit/s (I.S. ib) (Engineering port)	
Keyboard	for the connection of up to 32 potential-free contacts (switches / buttons)	
Data cables / lengths		
Copper (TX)	up to 100 m [328.08 ft] via CAT5 installation cable AWG22	
* Note on USB interfaces	The USB interfaces are based on USB 2.0. Due to explosion protection rules, the USB interface properties (such as speed or power supply) may be restricted.	
Real-time clock	yes, capacitor buffered, maintenance-free	
Data buffer	at least 4 days	
Status display LEDs	- Ethernet link and activity (green) - Ethernet speed (yellow)	
below the back cover		
in the Ex i compartment		
Processor	Cortex A8, 800 MHz	
Main memory	512 MB	
Data memory	1 GB Flash, 512 MB SSD	
Operating system	Windows Embedded Compact 7	
Languages	global, multilingual language support	
Number of protocol drivers	a maximum of 4 simultaneously	
Number of process images	> 1000 dynamic	
Number of texts / messages	dynamically limited by main memory	
Number of variables per page	255	
Number of messages	4096 fault messages, 4096 operation messages	
Font sets	4 independent Windows uncondensed fonts	
Software download		
Safe area	USB transfer via USB stick	
Explosion protection area	via Ethernet connection via intrinsically safe USB stick	
Note 1	Download with a connected VB-USB-PLUG cable is also possible from outside of the enclosure.	
Note 2	A software download via the serial interface is not possible.	
Enclosure	Aluminium / stainless steel 304	
Front	Specially hardened glass front plate on aluminium	
Ingress protection		
Front	IP66, IP69 according DIN EN 60529 IP65 according EN / IEC 60079-0	
Back side	IP54 according EN / IEC 60079-0	
HMI Types	PM = PanelMount = panel mount device OS = Operator Station	
HMI Types comment	Panel mount device (PM): devices without additional enclosure (HSG) and without additional accessories Operator Station (OS): devices mounted inside additional enclosure (HSG)	
Operating temperature range		
Operation	-40 °C ... +65 °C / [-40 °F ... +149 °F]	
Operation (functional)	-40 °C ... +70 °C * / [-40 °F ... +158 °F] *	
Storage temperature range	-40 °C ... +70 °C / [-40 °F ... +158 °F]	
* Remark	Functional operation at +70 °C / +158 °F for a maximum of 8 hours per day, +65 °C / +149 °F for continuous operation (24/7)	
HMI Types comment OS	If the HMI device is installed in an additional enclosure (HSG), the upper temperature limit is reduced by 5 °C / [41 °F], due to the device's own heating and lower temperature dissipation in the additional enclosure ! Thus, the operator stations offers "only" an operation temperature range of -40 °C ... +60 °C / [-40 °F ... +140 °F] !	
Heat dissipation	Cooling via back side	
Operation with heater	Automatic	
Cable glands		
Terminal compartment	Ex i	Ex e
Type	HSK-M-Ex (Ex e)	
Number	2 x M16 and 1 x M20	3 x M16 and 2 x M20
Thread size	M16 x 1,5 and M20 x 1,5	
Cable diameter range	M16 = 6 ... 10 mm / M20 = 6 ... 12 mm	
Width across flats	M16 = SW20 / M20 = SW22	

Relative humidity	90 % at +40 °C [+104 °F], without condensation	
Corrosion resistant	ISA-S71.04-1985, severity level G3, according to EN 60068-2-60	
Vibration	Level	test specification
Vibration (sinus)	5 up to 500 Hz ±1,00 mm up to 15,76 Hz 1 gn from 15,76 Hz 1 Okt./minute 20 cycle in all 3 axis axis X, Y, Z	IEC 60068-2-6 : 2008
Shock	18 impacts 15 g / 11 ms 18 impacts 25 g / 6 ms axis X, Y, Z	IEC 60068-2-27 : 2010
Positive pressure operation	< = 20 mbar	
Dimensions [mm] / [ft]		
Front (w x h)	290 x 146 / [0.95] x [0.48]	
Cut-out w x h [mm] (+/- 0.5) / [0.0016]	275 x 131 / [0.9] x [0.43]	
Depth of cut-out	83 / [0.27]	
Wall thickness	≤ 8 / [0.0087]	
Mounting orientation	any position	
Weight [kg] / [lbs]	5 / [11.02]	

3.1 Heater operation

The ET-208 Operator Interfaces have a heating system that is automatically switched on and off, thus ensuring operation even at low temperatures. If the temperature falls below -20 °C [-4 °F], the heating system comes on automatically and keeps the device at service temperature.

At temperatures above zero the system is switched off.

 NOTICE	<p>If the ET-208 Operator Interface has cooled down to temperatures below -20 °C [-4 °F] and is then switched on, <u>ONLY</u> the heating system will be activated initially !</p> <p>The device is then heated up and the other electric circuits will be energized only once the service temperature has been reached !</p> <p>Up to this point you cannot see that the ET-208 Operator Interface is working, as there are no status LEDs, and the display has not yet been activated !</p> <p>Depending on how low the temperature is, this process / state may last up to half an hour !</p>
---------------------------------------------------------------------------------------------------	---------------------------------------------------------------------------------------------------------------------------------------------------------------------------------------------------------------------------------------------------------------------------------------------------------------------------------------------------------------------------------------------------------------------------------------------------------------------------------------------------------------------------------------------------------------------------------------------------------

4 Conformity to standards

The ET-208 Operator Interfaces comply with the following standards and directive:

Standard	Classification
Initial certification	
ATEX Directive 2014/34/EU	
EN 60079-0 : 2012	General requirements
EN 60079-5 : 2015	Powder filling »q«
EN 60079-7 : 2007	Increased safety "e"
EN 60079-11 : 2012	Intrinsic safety "i"
EN 60079-31 : 2009	Protected by enclosures "t" (dust)
The product corresponds to requirements from:	
EN 60079-0 : 2012 + A11 : 2013	General requirements
EN IEC 60079-0 : 2018	
EN 60079-7 : 2015	Increased safety "e"
EN IEC 60079-7 : 2015 + A1 : 2018	
EN 60079-31 : 2014	Protected by enclosures "t" (dust)
Electromagnetic compatibility	
EMC Directive	
2014/30/EU	Classification
EN 61000-6-2 : 2005	Immunity
EN 61000-6-4 : 2007 + A1 : 2011	Interference emission
Low Voltage Directive	
2014/35/EU	Classification
EN 61010-1 / A1 / AC : 2019	Safety requirements for electrical equipment for measurement, control and laboratory use (General requirements)
RoHS Directive	
2011/65/EU	Classification
EN IEC 63000 : 2018	Technical documentation for the assessment of electrical and electronic products with respect to the restriction of hazardous substances
Other standards	
EN 60529 : 2014	Degrees of protection provided by enclosures (IP Code)

5 Certificates

The ET-208 Operator Interfaces are certified for installation in the following areas:

Synonym	Scope	Certificate number	Valid until	Comment
CE / ATEX	Europe	BVS 15 ATEX E 042 X	unlimited	
IECEX	Global	BVS 15.0039X	unlimited	
EAC	Russia	RU C-DE.HA91.B.00166/20	11.08.2025	
NEC	USA	UL E202379	unlimited	
CEC	Canada		unlimited	
CCC	China	2020312309000287	31.08.2025	
CNEX		CNEx18.3155X	17.07.2023	
KCC	Korea	R-R-RS3-ET208AC R-R-RS3-ET208DC	unlimited	
KCS		19-KA4BO-0206X 19-KA4BO-0207X	unlimited	
JPNEx	Japan	CML 19JPN5469X	11.12.2025	
PESO	India	A/P/HQ/TN/104/6230 (P541910/1)	31.12.2026	
BIS		R-41201782	07.09.2023	
DNV	Marine certification	TAA00002SK	28.05.2025	only version: ET-208-TX-W00-AC-GL



 DOCUMENTATION	You can access all IECEx certificates on the official website of the IEC under their certificate number. https://www.iecex-certs.com/#/home
----------------------------------------------------------------------------------------------------------	-------------------------------------------------------------------------------------------------------------------------------------------------------------------------------------------------

 NOTICE	The importer have to use exception documents which are applied in Korea rule for Korea. A corresponding example document, the so-called "Customer confirmation letter", is included in the CE_ET-208 certificate compilation of the devices.
---------------------------------------------------------------------------------------------------	-------------------------------------------------------------------------------------------------------------------------------------------------------------------------------------------------------------------------------------------------

5.1 FSB notification

	The FSB notification of the RAPTOR field systems can be reviewed under this link: https://portal.eaeunion.org/sites/odata/_layouts/15/Portal.EEC.Registry.Ui/DirectoryForm.aspx?ViewId=859ec98d-f4fe-423a-b6bc-d01b53fd4b7c&ListId=0e3ead06-5475-466a-a340-6f69c01b5687&ItemId=232#f=STAHL
-------------------------------------------------------------------------------------	--------------------------------------------------------------------------------------------------------------------------------------------------------------------------------------------------------------------------------------------------------------------------------------------------------------------------------------------------------------------------------------------------------------------------------------------------------------------------------------------------------------------------------------

6 Marking

Manufacturer	R. STAHL HMI Systems GmbH	
Type code	ET-208	
CE classification:	 0158	
Testing authority and certificate number:	BVS 15 ATEX E 042 X IECEX BVS 15.0039X	
Ex classification:		
ATEX guideline		II 2 G Ex eb ib q [ib] IIC T4 Gb II 2 D Ex tb ib [ib] IIIA T115°C Db
IECEX		Ex eb ib q [ib] IIC T4 Gb Ex tb ib [ib] IIIA T115°C Db
EAC		1Ex e ib q [ib] IIC T4 Gb X Ex tb ib [ib] IIIA T115°C Db X
CCC / CNEX		Ex e ib q [ib] IIC T4 Gb Ex tb ib [ib] IIIA T115°C Db
KCC / KCS		Ex e ib q [ib] IIC T4 Ex tb ib q [ib] IIIA T115°C
JPNEx		Ex e ib q [ib] IIC T4 Gb Ex tb ib [ib] IIIA T115°C Db Tamb: -40 °C to +65 °C
NEC / CEC		Class I, Zone 1, AEx e ib q [ib] IIC T4 Gb Zone 21, AEx tb ib [ib] IIIA/IIIC T115°C Db
PESO		Ex eb ib q [ib] IIC T4 Gb

7 Power supply

7.1 ET-208 Operator Interfaces

Power supply

Version DC:

Rated Voltage: 24 VDC
Input Voltage Range: 20.4 – 28.8 VDC

Version AC:

Rated Voltage Range: 115 - 230 VAC
Input Voltage Range: 85 – 253 VAC
Rated Frequency Range: 48 - 62 Hz

7.1.1 Terminals

Copper cables with the cross sections between 0.2 mm² (AWG25) and 2.5 mm² (AWG14) may be connected to the terminals X1, X2, X3, X4 and X5 of the ET-208 Operator Interfaces.

Copper cables with the cross sections between 0.14 mm² (AWG26) and 1.5 mm² (AWG16) may be connected to the terminals X7 and X9 of the ET-208 Operator Interfaces.



NOTICE

When connecting cables please ensure that the cable insulation reaches right up to the terminal contact.

7.1.1.1 Tightening torques

Terminals X1, X2, X3, X4 and X5 require a tightening torque of:

0.4 Nm to 0.5 Nm

and terminals X7 and X9 require a tightening torque of:

0.22 Nm to 0.25 Nm.



NOTICE

The stipulated tightening torques of the connection terminals must be observed and applied. Again, they must be checked and possibly adjusted before commissioning !

8 Permitted maximum values

8.1 External, non-intrinsically safe circuits

Input voltage (X1)

Rated voltage	24 VDC or 230 VAC (85 - 250 VAC; 48 - 62 Hz)
Power consumption at U_{rated}	1.6 A max
Max. working voltage U_m	253 VAC

RS-422/-485 COM 1 (X2):

Rated voltage	RS-422/-485: 5 VDC
Max. operating voltage U_m	30 VAC

RS-422/-485 COM 2 (X3):

Rated voltage	RS-422/-485: 5 VDC
Max. operating voltage U_m	30 VAC

USB1 (X4):

Rated voltage	5 VDC
Max. operating voltage U_m	30 VAC



CAUTION

Terminal X4.5 shall not be connected in hazardous areas !

Copper Ethernet (X5):

Rated voltage	5 VDC
Rated power	100 mW
Max. operating voltage U_m	30 VAC

8.2 External intrinsically safe circuits

USB2 (X7) or (X8):

 CAUTION	Connection via terminal block X7 or USB-socket X8 shall not be used at the same time !
--------------------------------------------------------------------------------------------------	----------------------------------------------------------------------------------------

Uo	=	5.45 V	
Io	=	755 mA	
Po	=	2.5 W	
Lo (IIC)	≤	4.8 μH	1.8 μH
Co (IIC)	≤	4.7 μF	27.7 μF
Lo (IIB)	≤	49.8 μH	19.8 μH
Co (IIB)	≤	20.7 μF	51.7 μF

Keyboard (X9):

		between connection / terminal X9.1 to X9.12	
Uo	=	4.96 V	
Io	=	60 mA	
Po	=	74 mW	
Lo (IIC)	≤	100 μH	20 μH
Co (IIC)	≤	6.7 μF	11.9 μF
Lo (IIB)	≤	100 μH	20 μH
Co (IIB)	≤	42 μF	95 μF

 NOTICE	The X9 interface is regarded as a joint signal circuit !
---------------------------------------------------------------------------------------------------	----------------------------------------------------------

9 Type code

ET-208-aa-bb-cc-GL

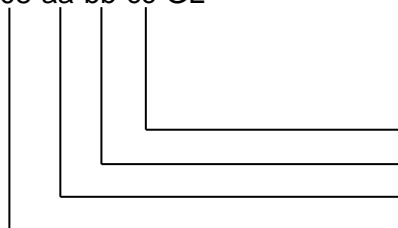



GL = Glass on aluminium
 Voltage supply
 Wireless option
 Ethernet interface
 18 cm / 7" Display

Product type:

Product key structure	Description
	Type with
ET-208- TX -bb-cc-GL	Copper 10/100Base-TX (Ex e) Ethernet interface
ET-208-aa- W00 -cc-GL	no WLAN
ET-208-aa-bb- AC -GL	Power supply 85 - 250 VAC, 48 - 62 Hz (Ex e)
ET-208-aa-bb- DC -GL	Power supply 24 VDC (Ex e)
ET-208-aa-bbb-cc- GLN	Glass on aluminium with neutral front

10 Safety Advice

 NOTICE	<p>This chapter is a summary of the key safety measures. The summary is supplementary to existing rules which staff also have to study.</p>
	<p>The safety of persons and equipment in hazardous areas depends on compliance with all relevant safety regulations. Thus, the installation and maintenance staff carry a particular responsibility, requiring precise knowledge of the applicable regulations and conditions.</p>

 CAUTION	<p>The notes listed below in section 10.1 must be heeded to avoid injury and damage to equipment !</p>
--------------------------------------------------------------------------------------------------	--------------------------------------------------------------------------------------------------------

10.1 Installation and operation

Please note the following when installing and operating the device:

- The national regulations for installation and assembly apply (e.g. IEC/EN 60079-14).
- The ET-208 Operator Interface may only be switched on when it is closed.
- The ET-208 Operator Interfaces may be installed in zones 1 or 2 and 21 or 22.
- The intrinsically safe circuits must be installed according to applicable regulations.
- When installed in zones 1, 2, 21 and 22, intrinsically safe devices suitable of categories 2G, 3G, 2D and 3D may be connected to the intrinsically safe power supply circuits.
- If the ET-208 Operator Interfaces are operated in areas at risk of dust explosions, the maximum values resulting from group IIB apply to the intrinsically safe circuits.
- Interconnecting several devices in a single intrinsically safe circuit can result in different safety characteristic values. This could compromise intrinsic safety !
- The safe maximum values of the connected field device(s) must correspond to the values listed on the data sheet or the EC-type examination certificates.
- After switching the ET-208 operator interface off, wait for at least 1 minute before opening it.
- Before opening the lid of the "e" compartment, users must ensure that all non-intrinsically safe circuits have been switched off. Circuits supplied from different sources may be connected !
Please note that all associated equipment must also be switched off !
- The ET-208 operator interface and any connected equipment must be incorporated into the same equipotential bonding system (see installation example in the Hardware Manual (Online version)). An alternative would be to connect only devices that are safely isolated from earth potential.
- National safety and accident prevention rules.
- Generally accepted technical rules.
- Safety instructions contained in these operating instructions.
- Any damage may compromise the explosion protection !

Use the ET-208 Operator Interface for its intended purpose only (see "[Device Function](#)").
 Incorrect or unauthorized use and non-compliance with the instructions in this manual will void any warranty on our part.
 No changes to the device that compromise its explosion protection are permitted !
 The ET-208 Operator Interface may only be installed and operated in an undamaged, dry and clean condition !

 CAUTION	If the device in its factory state is damaged or altered in any way, decommission it immediately and contact the manufacturer !
	If small glass beads (filling material) escape the device, immediately decommission the device !

10.2 Special conditions

 CAUTION	The intrinsically safe circuits are connected to earth. Along the intrinsically safe circuits, potential equalization must exist. Maximum overvoltage category II according to IEC 60664-1 is permitted for the non-intrinsically safe circuits.
	For use in explosive gas atmospheres the device may be built in the wall of an enclosure fulfilling all relevant clauses of IEC 60079-0. The device itself fulfills all mechanical requirements according to IEC 60079-0 and the degrees of protection IP65 according to IEC 60529 if mounted according to the Operating Instructions.

10.3 Industrial Security

Our products with Industrial Security functions support the secure operation of plants, systems and equipment. Protection against cyber threats requires an all-encompassing Industrial Security concept. The key to a successful concept is integrated implementation, continuous maintenance and state-of-the-art technology. This is the responsibility of the plant operator.

The following are key issues for an effective Industrial Security concept:

- Prevention of unauthorised access to plants, systems, equipment and networks
- Systems, equipment and components should only be connected to the company intranet or the internet if and when required
- Employ protective measures such as firewalls and network segmentation
- Only use the latest software product versions
- Carry out software updates as soon as new versions are available
- Use standard user accounts for regular operation
- Use secure passwords
- Appropriate safeguarding of administrator accounts
- Application of security guidelines
- Other measures to be taken as required

R. STAHL uses Windows 10 for its products. It does not develop any cryptographic functions.

R. STAHL does not configure / harden the operating system, nor does it provide or refer to security guidelines for doing so.

Furthermore, R. STAHL is constantly working on enhancing its products, thereby contributing to plant security and to minimizing the risk of cyber threats.

11 Installation

11.1 General information

 NOTICE	Electrical plants are subject to certain regulations concerning installation and operation (e.g. RL 1999/92/EC, RL 94/9/EC and IEC/EN 60079-14).
	The users of electrical installations in hazardous environments must ensure that the equipment is kept in proper condition, is operated according to instructions and that maintenance and repairs are carried out.

11.2 ET-208

- Operators must ensure compliance with the EC type examination certificates before installation. Users must adhere to any “special conditions” therein. Also of importance are the maximum electrical operating values specified therein.
- The earth / ground (equipotential bonding) connector at the back of the ET-208 Operator Interface's enclosure must be connected to the equipotential bonding conductor of the hazardous area. The earthing cable must have a minimum cross section of 4 mm² and be fitted properly. To prevent equalizing currents flowing to the earth / ground (equipotential bonding) system of the ET-208 Operator Interface it is necessary to safely isolate any connected devices from earth or to integrate them into the earth / ground (equipotential bonding) system of the ET-208 Operator Interface.
- The equipotential bonding connector of the ET-208 Operator Interface located at the back of the housing is internally connected with all GND terminals.
- The ET-208 Operator Interfaces may be installed in any position, provided there is sufficient air circulation guaranteeing that the service temperature is not exceeded.
- Intrinsically safe and non intrinsically safe conducting connection parts must be installed with a minimum distance of 50 mm.
- When connecting the ET-208 Operator Interfaces to the intrinsically safe circuits of the associated equipment the respective peak values of the field unit and the associated device must be observed to ensure explosion protection (proof of intrinsic safety).
- According to IEC 60950, a suitable, easily accessible circuit breaker must be installed outside of the ET-208 Operator Interface which can cut the power line.

11.2.1 Cable glands

- The tightening torques for the cable glands may vary depending on the cables and wires used. The users have to determine and apply the required torques themselves.
- In the case of ex-factory systems, all components are installed correctly and in accordance with applicable standards. Since storage or temperature etc. can have an impact on the cables and cable glands, the pre-installed screw connections must be checked and possibly tightened before commissioning.
- If they are too loose or too tight, the type of protection, sealing or strain relief might be negatively impacted.
- Cable glands with cap nut and without strain relief clamp should only be used for permanently installed cables and electrical lines. Installation of the required strain relief is the responsibility of the system set-up engineer.

11.2.2 Ingress Protection

11.2.2.1 IP54

The ET-208 Operator Interface meets the mechanical requirements for full IP54 according to IEC 60529.

11.2.2.2 IP65

Gas explosion hazardous area

The ET-208 meets the mechanical requirements of IEC 60079-0 and Ingress Protection IP65 according to IEC 60529 if it is installed according to these Operating Instructions or the Online Manual.

For this, the Operator interface may be integrated into an enclosure which adheres to all relevant sections of the IEC 60079-0.

The Operator Interface can also be installed in an enclosure with Increased Safety "e" type of protection. All connection compartments of the Operator Interface are fitted with suitable cable glands or stopping plugs.

Dust explosion hazardous area:

The ET-208 Operator Interface can also be operated in dust explosion hazardous areas requiring device groups IIIB or IIIC. For this, the Operator Interface must be installed in an enclosure that meets all relevant requirements of the IEC 60079-0 and IEC 60079-31 and has at least IP65.

11.2.2.3 IP66, IP69

The ET-208 meets the mechanical requirements of Ingress Protection IP66 / IP69 according to IEC 60529 if it is installed according to these Operating Instructions or the Online Manual and inside a suitable enclosure.

11.2.3 HMI installation in enclosures with degree of protection "e" or "t"

If the ET-208 Operator Interfaces are mounted inside an enclosure with degree of protection Ex e or Ex t, the mechanical impact protection and the IP of the enclosure (up to IP65) is retained even after the device has been installed. The internal separation requirements and the temperature conditions of the Ex e enclosure must adhere to the applicable directives. The distance between the terminals of the ET-208 Operator Interfaces and other, insulated conductive parts (except earth) within the Ex e enclosure must be at least 50 mm.



If it is mounted inside a suitable enclosure with protection type Ex t, the device may also be installed and operated in group IIIC.

11.2.4 Capacitive touch screen



The instructions listed below must be heeded to avoid injury and damage to equipment !

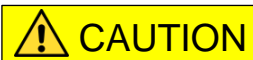

Malfunction:

To avoid malfunction and functional impairment of the touch screen the HMI device must be incorporated into the system's functional earth. The functional earth is used to suppress electromagnetic disturbance.

- Connect the equipotential bonding of the device with a short, low-resistance cable (minimum cross section 2.5 mm²) to a central earthing point in the system.

Incorrect / phantom operation:

Incorrect operation of the touch screen may result in accidental functions and errors. The operating device will then be unable to implement these, may implement these incorrectly or in a way not intended.

- Do not realise safety-relevant functions via the touch screen !
- Avoid accidental multi-touches !
- Do not touch the touch screen across a large area !
- Use a touch pen only for the capacitive touch screen !
- Before operating the device, thoroughly acquaint yourself with the multi-touch functions of the operating system and the application !
- Switch off the device for cleaning and maintenance.

Conductive liquids on the touch screen can result in incorrect or phantom operations. This applies in particular to salt water.

- Avoid contamination of the touch screen surface with salt water.

12 Assembly and disassembly

12.1 General information

 NOTICE	Assembly and disassembly are subject to general technical rules. Additional, specific safety regulations apply to electronic and pneumatic installations.
-------------------------------------------------------------------------------------------------	-----------------------------------------------------------------------------------------------------------------------------------------------------------

12.2 Cut-out ET-208

Make a cut-out with the following dimensions:

Width	Height	Depth of cut-out	Material thickness
275 ± 0.5 mm [0.9 ± 0.0016 ft]	131 ± 0.5 mm [0.43 ± 0.0016 ft]	85 mm [0.28 ± 0.0016 ft]	up to 8 mm [0.0087 ft]

The cut-out must be without burrs, clean and smooth.

12.3 Mounting ET-208

Mount the device from its back: Slide the fixing frame (included in the delivery) up to the front plate and then clip on and tighten the fixing brackets (torque of 0.4 - 0.6 Nm).

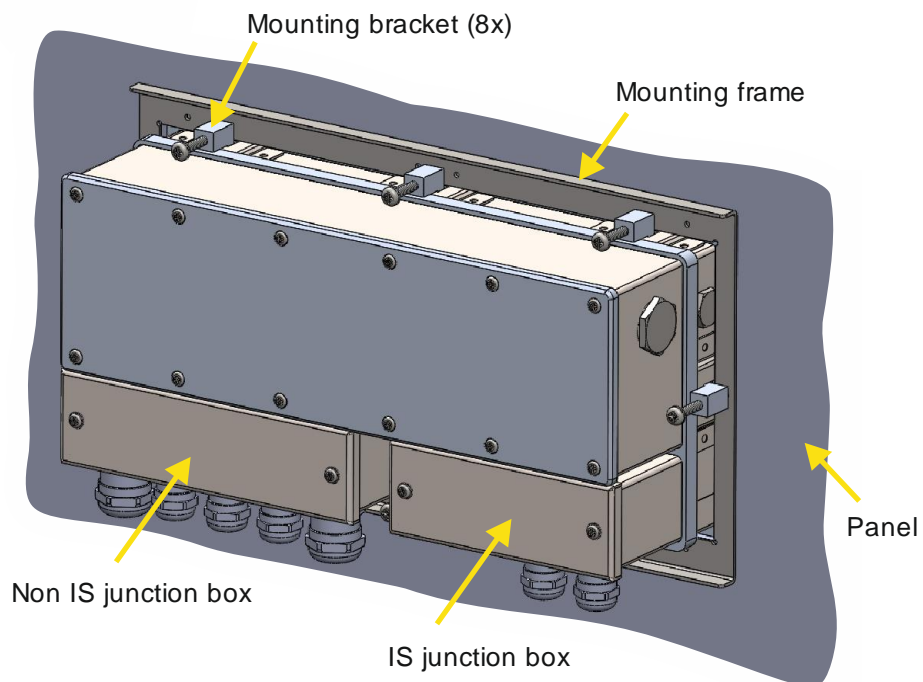

12.4 Views

Front:

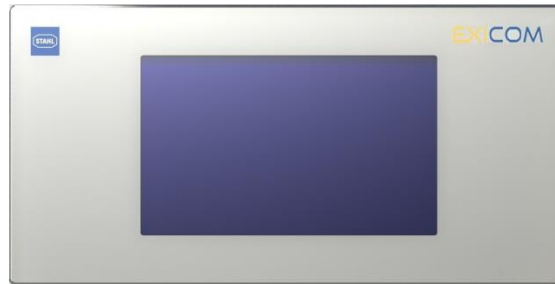

Back:

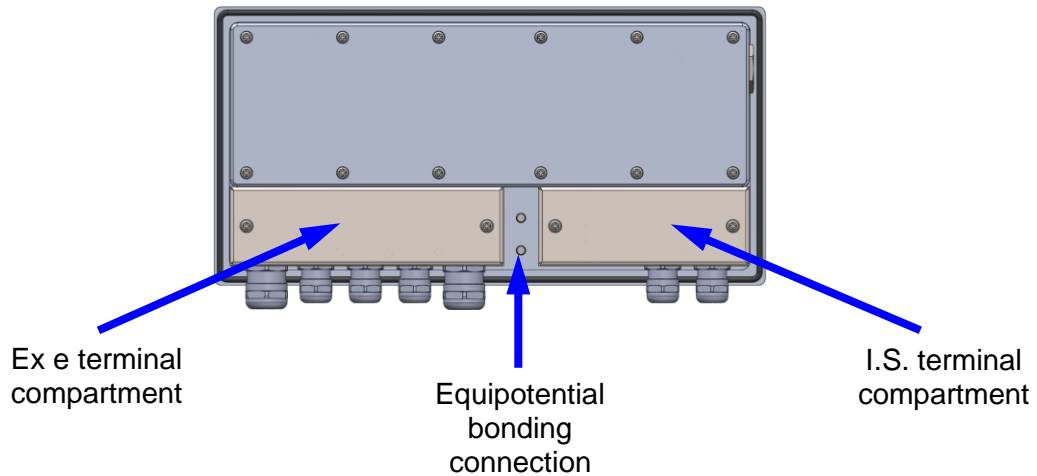

13 Operation

13.1 General information

 NOTICE	<p>When operating the devices, particular care shall be taken that:</p> <ul style="list-style-type: none">• the HMI device has been properly installed according to instructions,• the device is undamaged,• the terminal compartment is clean,• all screws are tightened fast,• before switching the HMI device on, its external PE terminal is properly connected to the equipotential bonding system at its place of use,• the cover of the terminal compartment is completely closed.
---------------------------------------------------------------------------------------------------	------------------------------------------------------------------------------------------------------------------------------------------------------------------------------------------------------------------------------------------------------------------------------------------------------------------------------------------------------------------------------------------------------------------------------------------------------------------------------------------------------------------------------------------------------

13.2 Connection Overview

Terminal	Pin	Meaning	Connection
X1	1	Power supply +24 VDC	DC
	2	Power supply 0 VDC	
	or		Power supply ET-208 (Ex e)
	1	Power supply L	
2	Power supply N	AC	
X2	1	TxD-b	COM1 serial interface (Ex e) RS-422/485
	2	TxD-a	
	3	RxD-b	
	4	RxD-a	
X3	1	TxD-b	COM2 serial interface (Ex e) RS-422/485
	2	TxD-a	
	3	RxD-b	
	4	RxD-a	
X4	1	VBUS (A)	USB1 (Ex e)
	2	D -	
	3	D +	
	4	GND	
	5 *	No connection allowed in hazardous areas !	
X5	1	RxD (-)	Ethernet interface copper (Ex e)
	2	RxD (+)	
	3	TxD (-)	
	4	TxD (+)	
X7	1	VBUS	USB2 (I.S.)
	2	D -	
	3	D +	
	4	GND	
	5	Shield	
X8		USB interface, connection type A	USB2 (I.S.)
X9	1	IN1	Connection of potential-free contacts (switches / keys) (I.S.)
	2	IN2	
	3	IN3	
	4	IN4	
	5	IN5	
	6	IN6	
	7	IN7	
	8	IN8	
	9	OUT1	
	10	OUT2	
	11	OUT3	
	12	OUT4	
	13	GND	



* Terminal X4.5 shall not be connected in hazardous areas !
Connection via terminal block X7 or USB-socket X8 shall not be used at the same time !

! NOTICE

The X9 interface is regarded as a joint signal circuit !
 Copper cables with a cross section between 0.2 mm² (AWG25) and 2.5 mm² (AWG14) may be used for terminals X1, X2, X3, X4 and X5 of the ET-208 Operator Interfaces.
 Copper cables with a cross section between 0.14 mm² (AWG26) and 1.5 mm² (AWG16) may be used for terminals X7 and X9 of the ET-208 Operator Interfaces.
 Which cable cross sections are chosen should be decided on the basis of relevant regulations, such as DIN VDE 0298. Factors that might require a larger cross section, such as current, increased temperatures, cable bundling, etc. must also be taken into account. Factors that might require a larger cross section, such as current, increased temperatures, cable bundling, etc. must also be taken into account.

View of the terminals:

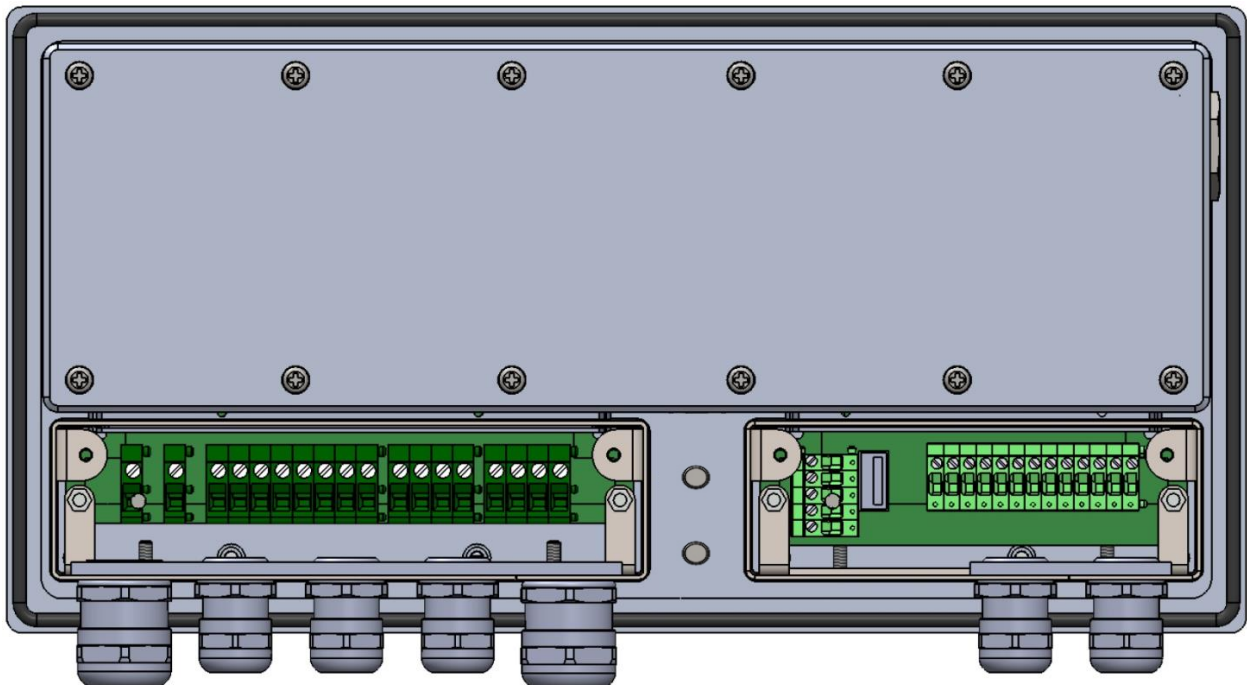

13.2.1 Connection details terminals

13.2.1.1 Ex e compartment

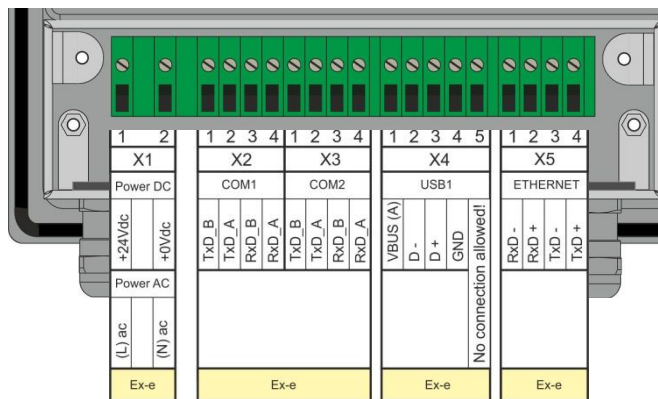

13.2.1.2 I.S. compartment

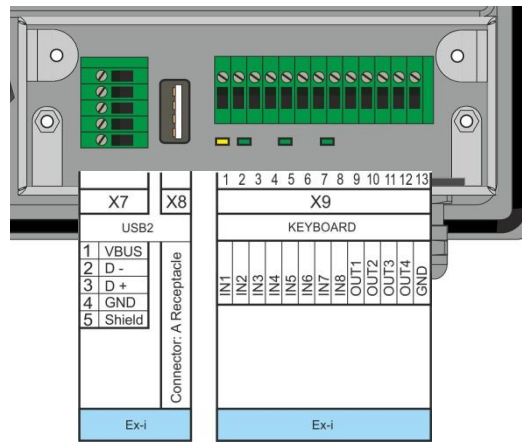

13.3 LEDs

The status of the respective LEDs in the I.S. compartment indicates the activity of the corresponding data lines.

Definition	Colour	Name	Description
LD1	green	Ethernet link / activity	Ethernet link established, LED always on Activity on Ethernet link, LED flashing
LD2	yellow	Ethernet speed	Speed 100 Mbit, LED always on Speed 10 Mbit, LED off
LD3	green	-	No function
LD4	green	-	No function

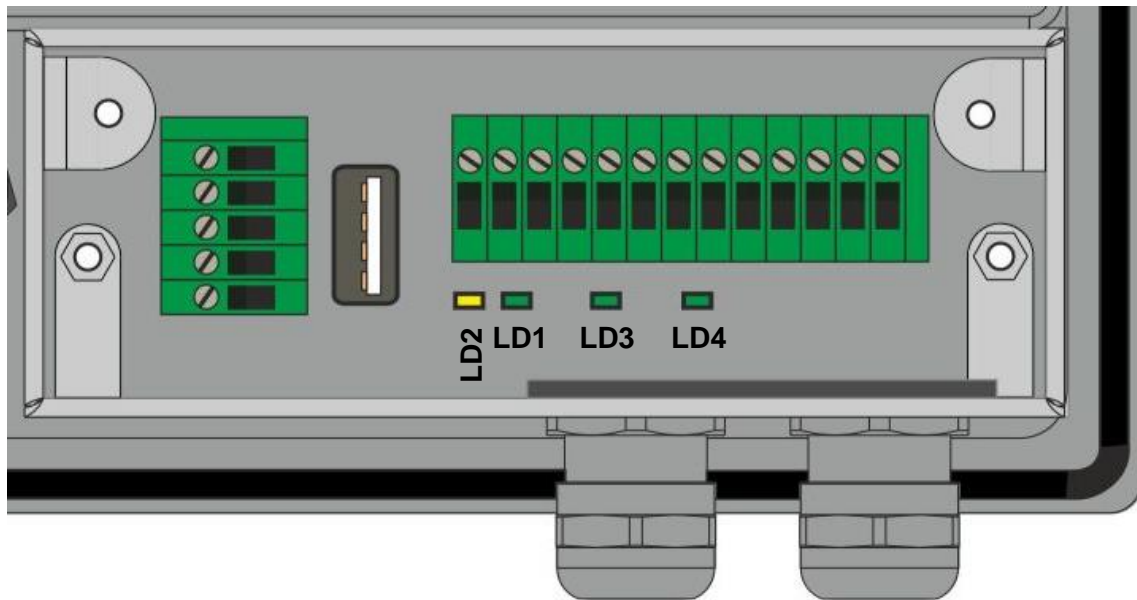

14 Maintenance, service

! NOTICE

Associated equipment is subject to maintenance, service and testing according to guidelines 1999/92/EC, IEC/EN 60079-14, -17, -19 and BetrSichVer (Betriebssicherheitsverordnung - Occupational Safety and Health) !

Because the transmission of the devices remains reliable and stable over long periods of time, regular adjustments are not required.

The following principles apply to repairs *, spare parts purchase* or exchange of parts * (where this can be done by the user !):

- Only original parts provided by the manufacturer must be used.
- Fuses may only be replaced by equivalent fuse types.

DOCUMENTATION

* Please also note [section Troubleshooting](#) !

The ET-208 Operator Interfaces are maintenance-free across their entire lifespan.

System maintenance should focus on the following:

- a. Seal wear
- b. Damage to front screen / glass
- c. All screws are tightened fast
- d. All cables and lines are properly connected and undamaged

! CAUTION

If the device in its factory state is damaged or altered in any way, decommission it immediately and contact the manufacturer !

If small glass beads (filling material) escape the device, immediately decommission the device !

14.1 Damaged sealing

! NOTICE

If a defective seal is found on a device that has been returned to the manufacturer, an agreement is made with the customer as to whether it should be repaired (replaced).

If this exchange is not necessary, the option "No hazloc approved panel mount" is marked on the device by the manufacturer.

The device is only approved for installation inside an Ex e or Ex tb enclosure if no "No hazloc approved panel mount" option is indicated on the device.

If the "No hazloc approved panel mount" option is indicated on the device, certification according to NEC / CEC is no longer possible or becomes void !

14.2 Repair

! CAUTION

Any repairs must always be carried out by the manufacturer.

The q space ("container") may only be opened by the manufacturer.

After the repair works, the manufacturer will re-fill the device using the same procedure as the one used during the manufacturing process.

14.3 Servicing



NOTICE

In accordance with IEC/EN 60079-19 and IEC/EN 60079-17, operators of electric plants in hazardous areas are obliged to have them serviced by qualified electricians.

14.4 Saving data with ET-208

All online data is stored on the internal flash card and are therefore also available after the operator interface has been switched off for a long time.

According to the current state-of-the-art the flash cards retain stored data for about 10 years.

14.5 Time function

A capacitor maintains the clock function of the ET-208 Operator Interfaces when they are switched off for about 4 days. If the operator interface is switched back on after a longer interval, the clock / date has to be set manually or via a connected system.

15 Troubleshooting



NOTICE

Devices operated in hazardous areas must not be modified.

Any repairs must always be carried out by the manufacturer. (see [section repair](#)) !

15.1 Repairs / hazardous substances

An error description must be enclosed with any units returned to R. STAHL HMI Systems GmbH for repairs.

Remove all material residues. Please pay particular attention to the seal grooves and slits where material residues may be lodged. We have to ask you not to return a unit if you are unable to completely remove any hazardous substances. We shall bill you for any costs arising from insufficiently cleaned units, such as disposal or damage to persons (chemical burns, etc.).

16 Disposal / Restricted substances

Disposal of old electric and electronic devices, packaging and used parts is subject to regulations valid in whichever country the device has been installed.

For countries under the jurisdiction of the EU the corresponding WEEE directive applies.

The devices are classified according to the table below:

Directive	WEEE II directive 2012/19/EU
Valid	from 2018-08-15
Category	SG2 screens, monitors, devices with monitors >100 cm ²

R. STAHL HMI Systems GmbH meets the requirements of directive 2012/19/EU (WEEE) and is registered under the number DE 15180083.

We shall take back our devices according to our General Terms and Conditions.

16.1 Declaration of substances and restricted substances

The present declaration is based on the procedure described in the international standard and directives as listed in the table below:

- IEC 62474 : 2018 (DIN EN IEC 62474 : 2019-09)
- (EG) Nr. 1907/2006 (REACH)
- Directive 2011/65/EU (RoHS)
- Resolution MEPC.269(68) "International Maritime Organization" (IMO); particularly "2015 Guidelines for the Development of the Inventory of the Hazardous Materials" (IHM)

16.1.1 Declarable substance groups

Component	Name	Mass (g)	Declarable Substance Groups and Substances (IEC 62474 database)	CAS No.	Mass %	Exemption (acc. to directive)
-	-	-	No SVHC material existing	-	-	-

16.1.2 RoHS directive 2011/65/EC

The devices meet the requirements of RoHS Directive 2011/65/EU.

16.1.3 China RoHS labelling

The part of all toxic or hazardous substance contained in the homogeneous materials of the HMI devices is below the limit requirements in SJ/T11363-2006.

16.1.4 IMO Resolution MEPC.269(68)

The devices meet the requirements of the MEPC.269(68) Resolution of the "International Maritime Organization" (IMO), in particular the "2015 Guidelines for the Development of the Inventory of the Hazardous Materials" (IHM).

17 General information

17.1 Touch driver

 NOTICE	<p>The UPDD touch driver is copyrighted licensed software supplied strictly for use with original R. STAHL HMI Systems GmbH touch systems and under no circumstances should this driver be downloaded or used on any other equipment !</p>
-------------------------------------------------------------------------------------------------	--------------------------------------------------------------------------------------------------------------------------------------------------------------------------------------------------------------------------------------------

18 Defective pixels

As a result of the manufacturing process (production tolerances and errors) for the displays they may be delivered with defective pixels. Provided they are within the range of the specification below these potential defective pixels are not a display or HMI error or defect.

18.1 Terminology

Defective pixels Pixels or sub-pixels that do not perform as expected and are either always on or always off

Pixel Image point on the display consisting of 3 sub-pixels in the basic colours red, green and blue



Dot Sub-pixel in the basic colour red, green or blue



Bright Sub-pixel (dot) to which light is passing through, creating a bright dot that is on

Dark Sub-pixel (dot) to which no light is passing through, creating a dark dot that is off

adjacent dots dots positioned next to one another, horizontally, vertically or diagonally, bright or dark (e.g. the following pattern and sub-pixels)

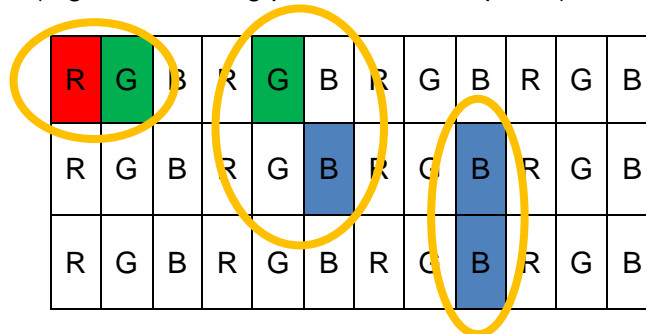

Distance between Dots

Definition of distance between two defective dots horizontal, vertical or diagonal, bright or dark (e.g. the following pattern and sub-pixels)

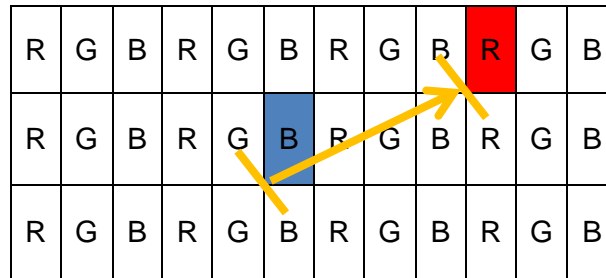

18.2 Display specification

Type of defect / description	max. number of permitted defects
Linear defect (horizontal, vertical)	not permitted
Defective pixels	
bright dots	≤ 2
dark dots	≤ 3
total number of dots	≤ 5
adjacent dots	
2 bright dots	≤ 1 pair
more than 3 bright dots	not permitted
2 dark dots	≤ 1 pair
more than 3 dark dots	not permitted
Distance between the dots	
between 2 bright dots	≥ 10 mm
between 2 dark dots	≥ 10 mm
ND filter for mura effects, bright and dark dots	view with 6% filter

19 Optical acceptance of surfaces

This section covers the acceptance criteria applicable to the minimum requirements for surfaces of devices and components.

The values for imperfection types listed under "tolerance limits" do not constitute a defect or an imperfection of the device or component and must therefore be tolerated.

19.1 Optical acceptance glass

Imperfection type	Criterion	Tolerance limits
Total imperfections	Number	Max. 3
Cleanness of glass surface	Clearly visible dirt	not permitted
Edge crack / incipient crack	visible	not permitted
Scratches	Width	up to 0.16 mm
	Length	up to 40 mm
	Cumulative length of all scratches	max. 40 mm
	Long side of glass < 300 mm, distance > 70 mm	
	Number	2
	Long side of glass 300 - 600 mm, distance > 70 mm	
Number		3
Hairline scratches / scraper damage	Width	max. 0.05 mm
	Length	max. 40 mm
Large point defects	Size	max. 0.4 mm ²
	Number	2
Small point defects	Size	max. 0.16 - 0.4 mm ²
	Number	5
Permitted point defects	Size	< 0.16 mm ² , provided there is no cluster ***
Interference points	Ø < 0.2 mm	permitted
	0.2 mm < Ø ≤ 0.6 mm	permitted provided there is no cluster ***
	0.6 mm < Ø ≤ 1.3 mm	5
	1.3 mm < Ø ≤ 2.0 mm	2
	Ø > 2.0 mm	not permitted
Inhomogeneity *	minor colour variations	permitted
White haze **	only visible in reflection	permitted
	not visible when device is in operating position.	permitted

	* in the case of coated float glass, inhomogeneity in the form of minor colour variations can occur and cannot be prevented by any technical means.
	** large, cloudy blemish, can be more pronounced towards the centre of the glass, but can also affect larger parts of the glass.
	*** a cluster is an accumulation of more than 7 disregarded, permitted imperfections that occur within an inspected area of a diameter of 40 mm.

19.2 Optical acceptance printing

Description	Tolerance limits
Labelling	Clearly legible, minimum stroke weight 0.3 mm
Characters	clearly legible
Lines and symbols	Gaps not permitted
Ink coverage	sufficient if underlying layers and structures not visible
Acutance	+/- 0.15 mm
Edge blurring	+/- 0.15 mm
Print overlap	possible colour variations in the overlap area are permitted
Variations of stroke weight	10 %
Within a shaping print	"Fine" as specified in DIN ISO 2768-1 General tolerance class
Between shaping prints	< 400 mm +/- 0.3 mm ≥ 400 mm +/- 0.5 mm

Imperfection type	Criterion	Tolerance limits
Dirt and dust particle inclusions, stains, fluff,	Size	max. 0.16 mm ²
	Size for weak colour contrast	max. 0.25 mm ²
	Number / 100 cm ²	1
	Minimum distance	80 mm
	Lower limit	0.063 mm ²





19.3 Optical acceptance, other surfaces

Definitions

Scratch	straight or curved / wavy surface damage
Dents / dings	plastic deformation inwards or outwards
Scuff mark without dent	"punch mark"-type depression

Surface categories

If not specified otherwise in the drawing, the following applies:

A surface	Surface is frequently viewed, typically the front plate. Surface is in customer's field of vision	
	Colour code	
B surface	Surface is occasionally viewed, typically the sides of the device	
	Colour code	
C surface	Surface is rarely viewed, typically the back or bottom of device	
	Colour code	
D surface	Surface is never viewed, typically the inside of the device	
	Colour code	

Accessories such as stand, wall bracket etc. are termed C surfaces



Imperfection type	A surface	B surface	C surface	D surface
Scratches	max. 1 per side	max. 2 per side	1x up to 100 mm with the grain	permitted
	0.05 – 0.1 mm wide and max. 10 mm long	0.05 – 0.1 mm wide and max. 10 mm long		
	or	or	and	
	0.01 – 0.05 mm wide and max. 40 mm long	0.01 – 0.05 mm wide and max. 40 mm long	3x up to 15 mm against the grain	
	only with the grain	only with the grain	1x up to 30 mm against the grain	
Gouges, depressions (punch-mark-type depression)	not permitted	not permitted	max. 2 per side	permitted
			max. 0.3 mm wide	
			max. 3 mm long	
Dents / cavities	not permitted	not permitted	not permitted	not permitted
welding flaws	not permitted	not permitted	not permitted	not permitted
Chatter marks	not permitted	not permitted	not permitted	not permitted
Material flaws	not permitted	not permitted	not permitted	not permitted
Orange peel: surface not homogeneous	not permitted	not permitted	not permitted	permitted

20 Control Drawing

20.1 USA / Canada UL

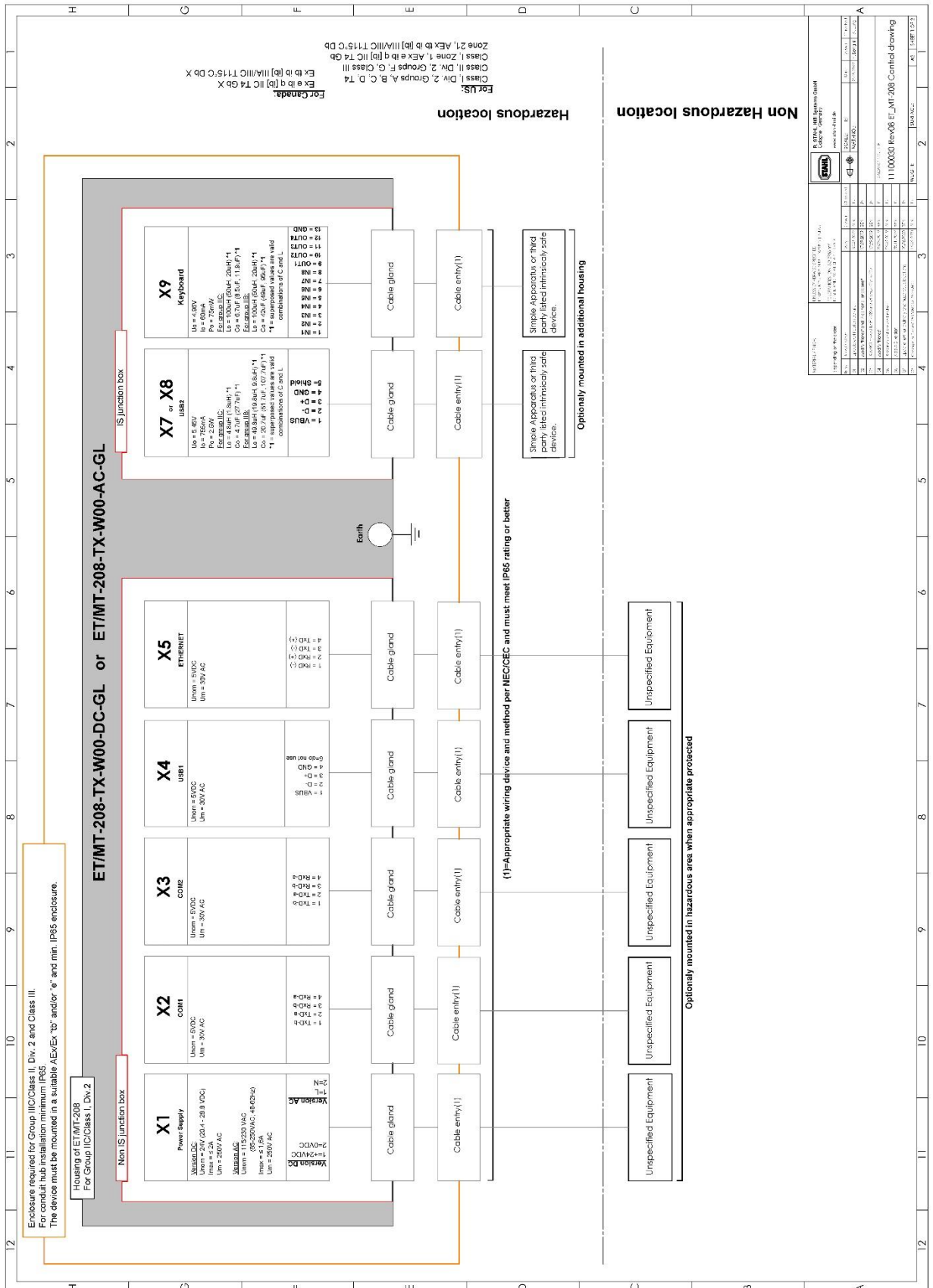

21 Declaration of conformity

21.1 EC

EU-Konformitätserklärung
EU Declaration of Conformity
Déclaration de Conformité UE



R. STAHL HMI Systems GmbH • Adolf-Grimme-Allee 8 • 50829 Köln, Germany

erklärt in alleiniger Verantwortung, *declares in its sole responsibility, déclare sous sa seule responsabilité,*

dass das Produkt: *that the product:* Bedien- und Beobachtungsgeräte
que le produit: *Operating and Monitoring Devices*
Consoles de commande et de visualisation

Typ(en), *type(s), type(s):* ET-208-TX-W00-**-GL*

mit den Anforderungen der folgenden Richtlinien und Normen übereinstimmt.
is in conformity with the requirements of the following directives and standards.
est conforme aux exigences des directives et des normes suivantes.

Richtlinie(n) / Directive(s) / Directive(s)	Norm(en) / Standard(s) / Norme(s)
2014/34/EU ATEX-Richtlinie 2014/34/EU ATEX Directive 2014/34/UE Directive ATEX	EN 60079-0:2012 Das Produkt entspricht Anforderungen aus: EN 60079-5:2015 <i>Product corresponds to requirements from:</i> EN 60079-7:2007 <i>Produit correspond aux exigences:</i> EN 60079-11:2012 EN 60079-0:2012/A11:2013 EN 60079-31:2009 EN IEC 60079-0:2018 EN 60079-7:2015 EN IEC 60079-7:2015 + A1:2018 EN 60079-31:2014

Kennzeichnung, *marking, marquage:* II 2G Ex eb ib q [ib] IIC T4 Gb 0158
 II 2D Ex tb ib [ib] IIIA T115 °C Db

EU-Baumusterprüfbescheinigung: *EU Type Examination Certificate:* BVS 15 ATEX E 042 X
Attestation d'examen UE de type: (DEKRA EXAM GmbH
 Dinnendahlstraße 9, 44809 Bochum, Germany, NB0158)

2014/30/EU EMV-Richtlinie 2014/30/EU EMC Directive 2014/30/UE Directive CEM	EN 61000-6-2:2005 EN 61000-6-4:2007 + A1:2011
Produktnormen nach Niederspannungsrichtlinie: <i>Product standards according to Low Voltage Directive:</i> <i>Normes des produit pour la Directive Basse Tension:</i>	EN 61010-1/A1/AC:2019
Produktnormen nach RoHS-Richtlinie (2011/65/EU): <i>Product standards according to RoHS Directive:</i> <i>Normes des produit pour la Directive RoHS:</i>	EN IEC 63000:2018
Sonstige Normen: <i>Other Standards:</i> <i>Autres normes:</i>	EN 60529:2014

Für spezifische Merkmale und Bedingungen siehe Betriebsanleitung.
For specific characteristics and conditions see operating instructions.
Pour les caractéristiques et conditions spécifiques, voir le mode d'emploi.

Köln, 2020-12-10

i.V.

i.V.

Ort und Datum
Place and date
Lieu et date

J. Düren
 Technical Director

A. Jung
 Ex Representative

21.2 EAC



**EURASIAN ECONOMIC UNION
DECLARATION OF CONFORMITY**



Applicant: Limited Liability Company «R.Stahl».
The main state registration number is 5087746541493.

Location (address of the legal entity) and the address of the place of business: 129085, Russia, Moscow, Zvezdny Boulevard, building 21, building 1, floor 6, room 1, room 12; phone number: +74956150473, E-mail address: info@stahl.ru.com.

represented by General Director Makhmudov Alexander Dzhamaleddinovich

declares that Control terminals of series ET and MT according to Appendix No. 1 on one sheet of this declaration.

manufacturer: R.STAHL HMI Systems GmbH,
Location (address of the legal entity) and address of the place of business activity: Adolf-Grimme-Allee 8, 50829 Koeln, Germany.

Products manufactured in accordance with the technical documentation R.STAHL HMI Systems GmbH.

HS Code: 8537 10 990 0

Serial release.

meets the requirements

TR EAEU 037/2016 On restriction of the use of certain hazardous substances in electrical and electronic equipment

The declaration of conformity was adopted on the basis of Test Reports № 121-HMI-20 28.02.2020 of the Testing Laboratory of the R.STAHL HMI Systems GmbH; operation manuals. Declaration scheme 1d.

Additional Information

Storage conditions of products in accordance with the requirements of GOST 15150-69. The shelf life (service, shelf life) is specified in the operational documentation attached to the product.

The declaration of conformity is valid from the date of registration to 22.03.2025 inclusive.

(Signature)

Stamp

Makhmudov Alexander Dzhamaleddinovich

(full name the Applicant)

Registration number of the declaration of conformity: EAЭС N RU Д-DE.PA01.B.27604/20

Date of registration of the declaration of conformity: 23.03.2020



ЕВРАЗИЙСКИЙ ЭКОНОМИЧЕСКИЙ СОЮЗ
ПРИЛОЖЕНИЕ № 1
К ДЕКЛАРАЦИИ О СООТВЕТСТВИИ ЕАЭС N RU Д-DE.РА01.В.27604/20

Перечень продукции, на которую распространяется действие декларации о соответствии

HS Code	Name and designation of products and (or) other designation	Name and designation of the document (s) in accordance with which the products are manufactured
8537 10 990 0	<p>Control terminals of series ET and MT: ET-**6-A-*_***, MT-**6-A-*_***, terminal type (ET or MT); ** type of operating system (3 = EAGLE (STAHL operating system); 4 = OPEN HMI (Windows, Linux OS); 5=REMOTE HMI (Windows); display size (0 = 10" VGA display; 1 = 10" SVGA display; 3 = 15" display; 5 = 19" display); 6 - fixed type code; A is the hardware version; *Ethernet interface (FX - fiber-optic cable; TX - cable with copper conductors); ***additional symbols that do not affect the design and means of explosion protection.</p> <p>T-Ex displays, MT - ##7 * - R2 * = any alphanumeric or symbolic character, without relevance for explosion protection # = one numeric character, without relevance for explosion protection</p> <p>ET-208</p> <p>ET-xx8, MT-xx8 First x = one numeric character, without relevance for explosion protection Second x = one numeric character reflect display size, without relevance for explosion protection</p>	<p align="center">Products manufactured in accordance with the technical documentation R.STAHL HMI Systems GmbH</p>

(Signature) 

Stamp

Makhmudov Alexander Dzhamaleddinovich

(full name the Applicant)

**ЕВРАЗИЙСКИЙ ЭКОНОМИЧЕСКИЙ СОЮЗ
ДЕКЛАРАЦИЯ О СООТВЕТСТВИИ**

Заявитель: Общество с ограниченной ответственностью «Р. ШТАЛЬ».

Основной государственный регистрационный номер: 5087746541493.

Место нахождения (адрес юридического лица) и адрес (адреса) места осуществления деятельности:
129085, Россия, Бульвар звездный, дом 21, строение 1, этаж 6, помещение 1, комната 12; номер
телефона: +74956150473, адрес электронной почты: info@stahl.ru.com.

в лице генерального директора Махмудова Александра Джамаледдиновича

заявляет, что Терминалы управления серий ET и MT, согласно приложению № 1 на одном листе к
настоящей декларации.

изготовитель: R.STAHL HMI Systems GmbH,

Место нахождения и адрес места осуществления деятельности по изготовлению продукции: Adolf-
Grimme-Allee 8, 50829 Koeln, Германия.

Продукция изготовлена в соответствии с технической документацией изготовителя R.STAHL HMI
Systems GmbH.

Код ТН ВЭД ЕАЭС: 8537 10 990 0

Серийный выпуск.

соответствует требованиям

ТР ЕАЭС 037/2016 "Об ограничении применения опасных веществ в изделиях электротехники и
радиоэлектроники"

Декларация о соответствии принята на основании Протокола испытаний № 121-HMI-20 от
28.02.2020, испытательной лаборатории R.STAHL HMI Systems GmbH; руководства по эксплуатации.
Схема декларирования 1д.

Дополнительная информация

Нормы, обеспечивающие соблюдение требований технического
регламента приведены в Приложениях №№ 2, 3 ТР ЕАЭС 037/2016 «Об ограничении применения
опасных веществ в изделиях электротехники и радиоэлектроники». Условия хранения конкретного
изделия, срок хранения и службы указываются в прилагаемой к продукции товаросопроводительной и
эксплуатационной документации.

Декларация о соответствии действительна с даты регистрации по 22.03.2025 включительно.

(подпись)

М.П.

Махмудов Александр Джамаледдинович

(Ф.И.О. заявителя)

Регистрационный номер декларации о соответствии: ЕАЭС N RU Д-ДЕ.РА01.В.27604/20

Дата регистрации декларации о соответствии: 23.03.2020

ЕВРАЗИЙСКИЙ ЭКОНОМИЧЕСКИЙ СОЮЗ
ПРИЛОЖЕНИЕ № 1
К ДЕКЛАРАЦИИ О СООТВЕТСТВИИ
ЕАЭС N RU Д- DE.РА01.В.27604/20



Перечень продукции, на которую распространяется действие декларации о соответствии

Код ТН ВЭД ЕАЭС	Наименование и обозначение продукции и (или) иное условное обозначение	Наименование и обозначение документа (документов), в соответствии с которым изготовлена продукция
8537 10 990 0	<p>Терминалы управления серий ET и MT:</p> <p>ET-**6-A-***, MT-**6-A-***, где ET или MT – обозначает тип терминала; ** тип операционной системы (3=EAGLE (операционная система STAHL); 4=OPEN HMI (Windows, Linux OS); 5=REMOTE HMI (Windows) и размер дисплея (0=10" VGA дисплей; 1=10" SVGA дисплей; 3=15" дисплей; 5=19" дисплей); 6 - фиксированный код типа; *- Ethernet-интерфейс (FX – волоконно-оптический кабель; TX – кабель с медными жилами); ***- дополнительные символы, не влияющие на конструкцию;</p> <p>T-Eх дисплеи, MT - ## 7 * - R2;</p> <p>Где * - любое буквенно-цифровой обозначение, или символ, не влияющие на характеристики устройства</p> <p># - один цифровой символ, не влияющие на характеристики устройства;</p> <p>ET-208: ET-xx8, MT-xx8, где первый x - один числовой символ, не влияющие на характеристики устройства, второй x - один числовой символ отражает размер дисплея.</p>	<p>Техническая документация изготовителя R.STAHL HMI Systems GmbH.</p>

(подпись)

М.П.

Махмудов Александр Джамаледдинович

(Ф.И.О. заявителя)

21.3 CCC

21.3.1 English version

		CERTIFICATE FOR CHINA COMPULSORY PRODUCT CERTIFICATION	
No.: 2020312309000287			
Applicant	R. STAHL HMI Systems GmbH	Address	Adolf-Grimme Allee 8, D-50829 Köln, Germany
Manufacturer	R. STAHL HMI Systems GmbH	Address	Adolf-Grimme Allee 8, D-50829 Köln, Germany
Production Factory	R. STAHL HMI Systems GmbH	Production Address	Adolf-Grimme Allee 8, D-50829 Köln, Germany
Product	Operator Terminal		
Model/Type	ET-208		
Ex marking	Ex e ib q [ib] II C T4 Gb, Ex tD ibD [ibD] A22 IP54 T115°C		
Reference Standards	GB3836.1-2010, GB3836.3-2010, GB3836.4-2010, GB/T3836.7-2017, GB12476.1-2013, GB12476.4-2010, GB12476.5-2013		
Certification mode	Type Test + Initial Factory Inspection + Post-Certification Surveillance		
The product(s) is verified and certified according to CNCA-C23-01: 2019 <i>China Compulsory Certification Implementation Rule on Explosion Protected Electrical Product</i> and CNEC-C2301-2019 <i>Guideline of China Compulsory Certification Implementation Rule on Explosion Protected Electrical Product</i> .			
See Annex for the detailed product information (4 pages)			
Issued on: 2020-09-01		Valid to: 2025-08-31	
The validity of this certificate is maintained through the regular supervision of the issuing authority during the validity period.			
Where any discrepancy arises between the English translation and the original Chinese version, the Chinese version shall prevail.			
			Director: 
Nanyang Explosion Protected Electrical Apparatus Research Institute Co.,Ltd.		 中国认可 产品 PRODUCT CNAS C208-P	
http://www.ccc-cnex.com ccc.china-ex.com	Add: No. 20, North Zhongjing Road, Nanyang, Henan, P. R. China Tel: 0377-63239734	P.C.: 473008 Email: ccc@cn-ex.com	

CN 000013



CERTIFICATE FOR CHINA COMPULSORY PRODUCT CERTIFICATION
(Annex)

No.: 2020312309000287

Page 1 of 4

Product information:

1. This certificate covers the following models:

- ET-208-TX-W00-**-GL

** : AC supply or DC supply

Parameters:

Non-Intrinsically safe circuits

1. Power supply input, Connection via terminal block X1

for type ET-208-TX-W00-AC-GL:

Terminals X1 (L, N)				
Rated voltage	AC	115 / 230		V
Rated current		≤ 2		A
Rated power				
Heater off		18		W
Heater on		36		W
Max. input voltage	U _m	AC	253	V

for type ET-208-TX-W00-DC-GL:

Terminals X1 (+, -)				
Rated voltage	DC	24		V
Rated current		≤ 1.6		A
Rated power				
Heater off		12		W
Heater on		22		W
Max. input voltage	U _m	AC	253	V

2. Com1 RS-422 interface

Connection via terminal block X2, terminals X2 (1, 2, 3, 4)
Rated voltage 5 V

Issued on: 2020-09-01

Director:



Nanyang Explosion Protected Electrical Apparatus Research Institute Co.,Ltd.



<http://www.ccc-cnex.com>
ccc.china-ex.com

Add: No. 20, North Zhongjing Road, Nanyang, Henan, P. R. China P.C.: 473008
Tel: 0377-63239734

Email: ccc@cn-ex.com



CERTIFICATE FOR CHINA COMPULSORY PRODUCT CERTIFICATION
(Annex)

No.: 2020312309000287

Page 2 of 4

Max. input voltage	U_m	30	V
3. Com2 RS-422 interface			
Connection via terminal block X3, terminals X3 (1, 2, 3, 4)			
Rated voltage		5	V
Max. input voltage	U_m	30	V
4. Ethernet TP interface			
Connection via terminal block X5, terminals X5 (1, 2, 3, 4)			
Rated voltage		5	V
Max. input voltage	U_m	30	V
5. USB interface			
Connection via terminal block X4, terminals X4 (1, 2, 3, 4)			
Rated voltage		5	V
Max. input voltage	U_m	30	V
Terminal X4.5 shall not be connected inside explosive areas!			

Intrinsically safe circuits

- Intrinsically safe USB circuit
Connection via terminal block X7 or USB-socket X8. X7 and X8 shall not be used at the same time.

Terminal block X7:
Terminals 1(VBUS), 2(D-), 3(D+) and 4(GND)
Terminal 5 (shield) is intended for the connection of a cable shield.

Max. output voltage	U_o	DC	5.45	V
Max. output current	I_o		755	mA
Max. output power	P_o		2.5	W

Maximum permissible (combined) values for external capacitance C_o and external inductance L_o in accordance with the following tables:
for group IIC:

Issued on: 2020-09-01

Director:



Nanyang Explosion Protected Electrical Apparatus Research Institute Co.,Ltd.



<http://www.ccc-cnex.com>
ccc.china-ex.com

Add: No. 20, North Zhongjing Road, Nanyang, Henan, P. R. China
Tel: 0377-63239734

P.C.: 473008
Email: ccc@cn-ex.com



CERTIFICATE FOR CHINA COMPULSORY PRODUCT CERTIFICATION
(Annex)

No.: 2020312309000287

Page 3 of 4

L _o [μH]	4.8	1.8	
C _o [μF]	4.7	27.7	
for group IIB resp. group III:			
L _o [μH]	49.8	19.8	9.8
C _o [μF]	20.7	51.7	107.7

2. Intrinsically safe interface for the connection of a keyboard

Connection via terminal block X9, terminals 1...12 and 13 (GND)

Max. output voltage	U _o	DC	4.96	V
Max. output current	I _o		60	mA
Linear output characteristics				
Max. output power	P _o		75	mW

Maximum permissible (combined) values for external capacitance C_o and external inductance L_o in accordance with the following tables:

for group IIC:

L _o [μH]	100	50	20
C _o [μF]	6.7	8.5	11.9

for group IIB resp. group III:

L _o [μH]	100	50	20
C _o [μF]	42	49	95

<u>Ambient temperature range:</u>	T _a	-40 °C...+65 °C
temperature class		T4
max. surface temperature with thermofuse limited to		115 °C

Ex marking: Ex e ib q [ib] IIC T4 Gb, Ex tD ibD [ibD] A22 IP54 T115°C

- Producers should organize production in accordance with the technical documents approved by the certification body.
- 2. Specific conditions of safety use:
 - The intrinsically safe circuits are connected to earth. Along the intrinsically safe

Issued on: 2020-09-01

Director:



Nanyang Explosion Protected Electrical Apparatus Research Institute Co.,Ltd.



<http://www.ccc-cnex.com>
ccc.china-ex.com

Add: No. 20, North Zhongjing Road, Nanyang, Henan, P. R. China P.C.: 473008
Tel: 0377-63239734 Email: ccc@cn-ex.com



CERTIFICATE FOR CHINA COMPULSORY PRODUCT CERTIFICATION (Annex)

No.: 2020312309000287

Page 4 of 4

circuits, potential equalization must exist. Maximum overvoltage category II according to GB/T16935.1 is permitted for the non-intrinsically safe circuits.

- For use in explosive gas atmospheres the terminal may be built in the wall of an enclosure fulfilling all relevant clauses of GB3836.1.
The terminal itself fulfills all mechanical requirements according to GB3836.1 and the degrees of protection IP65 according to GB/T4208 if mounted according to the user's manual.
 - The Operator Terminal can also be used in zone 21 of explosive dust atmospheres. Therefor it has to be integrated in the wall of an enclosure fulfilling all applicable requirements of GB12476.1, GB12476.5. A minimum degree of protection of IP65 shall be ensured.
 - See instruction for other information.
3. Certificate related report(s):
- Type test report: CQST2005C018.
 - Factory inspection report: CN2020Q010071.
4. Certificate change information: None

Issued on: 2020-09-01

Director:



Nanyang Explosion Protected Electrical
Apparatus Research Institute Co.,Ltd.



<http://www.ccc-cnex.com>
ccc.china-ex.com

Add: No. 20, North Zhongjing Road, Nanyang, Henan, P. R. China P.C.: 473008
Tel: 0377-63239734

Email: ccc@cn-ex.com

21.3.2 Chinese version



中国国家强制性产品认证证书

编 号：2020312309000287

委 托 人	R. STAHL HMI Systems GmbH
地 址	Adolf-Grimme Allee 8, D-50829 Köln, Germany
生 产 者	R. STAHL HMI Systems GmbH
地 址	Adolf-Grimme Allee 8, D-50829 Köln, Germany
生 产 企 业	R. STAHL HMI Systems GmbH
生 产 地 址	Adolf-Grimme Allee 8, D-50829 Köln, Germany
产 品 名 称	防爆人机界面 (操作屏)
型 号 规 格	ET-208
防 爆 标 志	Ex e ib q [ib] II C T4 Gb, Ex tD ibD [ibD] A22 IP54 T115°C
依 据 标 准	GB3836.1-2010, GB3836.3-2010, GB3836.4-2010, GB/T3836.7-2017, GB12476.1-2013, GB12476.4-2010, GB12476.5-2013

认 证 模 式 **型式试验+初始工厂检查+获证后监督**

上述产品符合 **CNCA-C23-01: 2019《强制性产品认证实施规则 防爆电气》**
和 **CNEX-C2301-2019《强制性产品认证实施细则 防爆电气》** 的要求。

产品相关信息见附页 (共 4 页)。

颁发日期 2020 年 09 月 02 日 有效期至 2025 年 09 月 01 日

证书有效期内本证书的有效性依据发证机构的定期监督获得保持。

主任： 





南阳防爆电气研究所有限公司



中国认可
产品
PRODUCT
CNAS C208-P

网址： www.ccc-cnex.com
ccc.china-ex.com

地址： 中国河南省南阳市仲景北路20号
电话： 0377-63239734

邮政编码： 473008
邮箱： ccc@cn-ex.com

CN 0007620



中国国家强制性产品认证证书 (附页)

编 号: 2020312309000287

第 1 页 共 4 页

产品相关信息:

1、本证书覆盖产品如下:

- ET-208-TX-W00-**-GL

型号含义:

ET-208-TX-W00-**-GL

** : AC 电源
DC 电源

电气参数:

非本安电路

1) 电源输入 通过端子 X1 连接

ET-208-TX-W00-AC-GL 端子 X1 (L、N) :

额定电压	AC 115/230V
额定电流	≤2A
额定功率	
加热器关闭	18W
加热器开启	36W
最大输入电压 Um	AC 253V

ET-208-TX-W00-DC-GL 端子 X1 (+、-) :

额定电压	DC24V
额定电流	≤1.6A
额定功率	
加热器关闭	12W
加热器开启	22W

颁发日期 2020 年 09 月 02 日

主任: 穆大玉



南阳防爆电气研究所有限公司



网址: www.ccc-cnex.com
ccc.china-ex.com

地址: 中国河南省南阳市仲景北路20号
电话: 0377-63239734

邮政编码: 473008
邮箱: ccc@cn-ex.com



中国国家强制性产品认证证书 (附页)

编 号: 2020312309000287

第 2 页 共 4 页

最高输入电压 U_m AC253V

- 2) RS-422 接口 Com1
通过端子 X2 连接, X2 (1、2、3、4)
额定电压 5V
最高输入电压 U_m 30V
- 3) RS-422 接口 Com2
通过端子 X3 连接, X3 (1、2、3、4)
额定电压 5V
最高输入电压 U_m 30V
- 4) 以太网 TP 接口
通过端子 X5 连接, X5 (1、2、3、4)
额定电压 5V
最高输入电压 U_m 30V
- 5) USB 接口
通过端子 X4 连接, X4 (1、2、3、4)
额定电压 5V
最高输入电压 U_m 30V
爆炸危险环境中不得连接端子 X4.5!

本安电路

1) USB 本安电路

通过端子 X7 或 USB 接口 X8 进行连接。X7 和 X8 不得同时使用。

接线端子 X7:

端子 1 (VBUS)、2 (D-)、3 (D+)、4 (GND)
端子 5 (屏蔽层) 用于连接电缆屏蔽层。
最大输出电压 U_o DC 5.45V
最大输出电流 I_o 755mA
最大输出功率 P_o 2.5W

颁发日期 2020 年 09 月 02 日

主任: 穆大玉



南阳防爆电气研究所有限公司



网址: www.ccc-cnex.com
ccc.china-ex.com

地址: 中国河南省南阳市仲景北路20号
电话: 0377-63239734

邮政编码: 473008
邮箱: ccc@cn-ex.com



中国国家强制性产品认证证书 (附页)

编 号: 2020312309000287

第 3 页 共 4 页

下表列出了外部电容 Co 和外部电感 Lo 的最大允许 (组合) 值

IIC

Lo [μ H]	4.8	1.8
Co [μ F]	4.7	27.7

IIB 及粉尘环境

Lo [μ H]	49.8	19.8	9.8
Co [μ F]	20.7	51.7	107.7

2) 用于键盘连接的本安接口

通过端子 X9、端子 1-12 和 13 (GND) 进行连接

最大输出电压	U_o	DC 4.96V
最大输出电流	I_o	60mA
线性输出特性		
最大输出功率	P_o	75mW

下表列出了外部电容 Co 和外部电感 Lo 的最大允许 (组合) 值

IIC

Lo [μ H]	100	50	20
Co [μ F]	6.7	8.5	11.9

IIB 及粉尘环境

Lo [μ H]	100	50	20
Co [μ F]	42	49	95

使用环境温度 -40°C ~ +65°C

熔断器限制最高表面温度 115°C

颁发日期 2020 年 09 月 02 日

主任:



南阳防爆电气研究所有限公司



网址: www.ccc-cnex.com
ccc.china-ex.com

地址: 中国河南省南阳市仲景北路20号
电话: 0377-63239734

邮政编码: 473008
邮箱: ccc@cn-ex.com



中国国家强制性产品认证证书 (附页)

编 号: 2020312309000287

第 4 页 共 4 页

防爆标志: Ex e ib q [ib] II C T4 Gb, Ex tD ibD [ibD] A22 IP54 T115°C

- 生产者应按照认证机构批准的技术文件组织生产。

2、安全使用条件:

- 本安电路需接地, 本安电路中需设置等电位连接, 非本安电路允许的最大过电压类别为 II 类 (GB/T16935.1)。
- 在爆炸性气体环境中使用时, 可将操作屏安装在符合 GB3836.1 相关条款的外壳中。

如果按照用户手册进行安装, 则该操作终端应满足 GB3836.1 的所有机械要求和 GB/T4208 的 IP65 防护等级。

- 操作屏也可用于爆炸性粉尘环境的 21 区。为此, 必须将其集成到满足 GB12476.1、GB12476.5 所有适用要求的机柜中, 应确保安装后其最低防护等级为 IP65。
- 其他见产品使用说明书。

3、证书关联报告:

- 产品型式试验报告: CQST2005C018
- 工厂检查报告: CN2020Q010071

4、证书变更信息: 无

颁发日期 2020 年 09 月 02 日

主任: 穆大玉



南阳防爆电气研究所有限公司



网址: www.ccc-cnex.com
ccc.china-ex.com

地址: 中国河南省南阳市仲景北路20号
电话: 0377-63239734

邮政编码: 473008
邮箱: ccc@cn-ex.com

22 Release notes

The chapter entitled "Release Notes" contains all the changes made in every version of the Operating Instructions.

Version 01.00.29

- Addition of "FSB notification"
- Changing text (with and without lettering) according to documentation note in "Specific markings"
- Changing text in note "No hazloc approved panel mount"
- Addition of "Note on USB interfaces" in "Technical Data"
- Changing HW Rev at cover
- Addition of BIS certification
- Addition of content in Table "Overview hardware revision"
- Changing "Heat dissipation" in "Technical Data", now "Cooling via back side"
- Adoption of the CCC certificate from the "certificate compilation"
- Formal changes

Version 01.00.30

- Deletion of previous release notes
- Addition of "corrosion resistant" in "Technical Data"
- "Valid until" column added to "Certificates" table
- Data of values for the certifications for "Valid to" added
- New IECEx link
- Note for Korea added to "Customer confirmation letter"
- Addition of text section "uses Windows 10 for its products" in "Industrial Security"
- Addition of text according to "NEC / CEC certification is no longer possible" at "No hazlock..." in "Damaged sealing"
- Formal changes

Version 01.00.31

- Correction of phone and fax no.
- Renew PESO (India) certification
- Addition of PESO marking
- Renew JPNEEx (Japan) certification
- Changing from DNV / GL -> into DNV
- Correction of certification designation KGS for Korea -> into KCS
- Addition of the "TC" field function in certificates
- Changing text (with and without lettering) according to important information note in "Specific markings"
- Addition of section "Optical acceptance of surfaces"
- Addition of attributes according to "HMI Types" in "Technical Data"
- Formal changes

R. STAHL HMI Systems GmbH
Adolf-Grimme-Allee 8
D 50829 Köln

T:	(Sales Support)	+49 221 768 06 - 1200
	(Technical Support)	+49 221 768 06 - 5000
F:		+49 221 768 06 - 4200
E:	(Sales Support)	sales.dehm@r-stahl.com
	(Technical Support)	support.dehm@r-stahl.com

r-stahl.com
exicom.de



THE STRONGEST LINK.