

Safety Barriers

Series 9001 / 9002 / 9004



www.stahl.de



10064E00

- > Complete product range for all standard applications
- > Flexible and space saving - single and dual channel versions on 12 mm only
- > Time-saving installation thanks to simultaneous
 - snapping onto the rail and
 - connecting to PE and earth
- > Reduced inventory due to uniform exchangeable fuse

A2



Safety barriers are used to connect intrinsically safe (Ex i) circuits with non-intrinsically safe circuits. The barriers limit the electrical energy towards the hazardous area by means of a combination of Zener diodes, resistors and fuses.

Safety barriers featuring an extremely broad application area.

		ATEX / IECEx						NEC 505						NEC 506						NEC 500							
		0		1		2		20		21		22		Class I		Class II		Class III		Class I		Class II		Class III			
Zone																				Division	1	2	1	2	1	2	
9001, 9002: Ex i interfaces		x	x	x	x	x	x													9001, 9002: Ex i interfaces	x	x	x	x	x	x	
9004: Ex i interfaces				x	x			x	x											9004: Ex i interfaces			x		x		x
Installation in						x									x					Installation in			x			x	

¹⁾ Restrictions see table explosion protection

9001: WebCode 9001A
 9002: WebCode 9002A
 9004: WebCode 9004A

Safety Barriers

Series 9001 / 9002 / 9004



Advantages at a Glance:

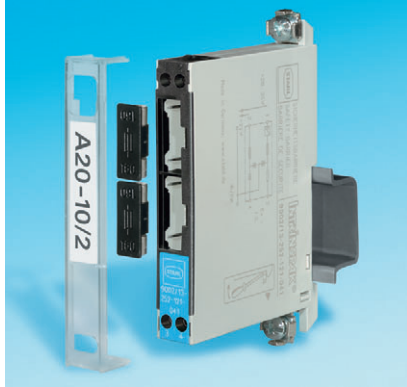

04102E00

If single or dual channel, the safety barriers offer a low cost and space saving solution on 12 mm foot print. The transparent cover offers sufficient space for labeling.

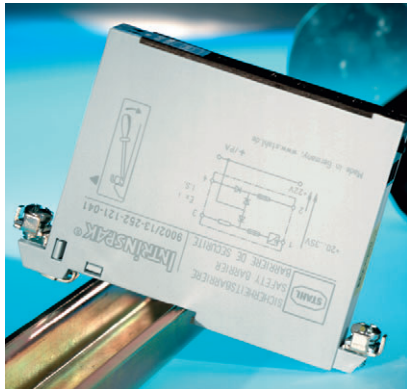

04104E00

Snapping-on mounts the barrier mechanically, it simultaneously establishes the PE connection. Therefore only one common PE connection is needed per DIN rail. Time and energy-intensive wiring is dispensed with, however, manual wiring is still an installation option. Even if other rails are used, adapters guarantee that the safety barriers possess a high degree of flexibility.



04092E00

An easily exchangeable back-up fuse protects the internal fuse and the safety barrier itself. Only one nominal fuses value is required for all models. This back-up fuse can be replaced without dismantling the barrier and without deenergizing the circuit.

Introduction

Application

Safety barriers are used as economical interfaces without galvanic isolation between intrinsically safe and non-intrinsically safe circuits. They protect circuits (i. e. cable and apparatus) in hazardous locations.

Safety barriers are so-called associated apparatus:

Since they also contain non-intrinsically circuits they must either be installed in the safe area or if certified in Zone 2 / Division 2. The combination with an further type of explosion protection (e.g. flame proof enclosure) enables the installation in Zone 1.

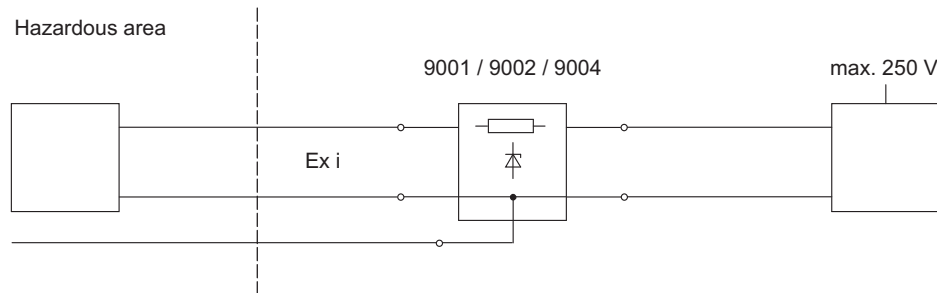

09911E02

Function

Safety barriers are used to limit the power supply into an intrinsically circuit in such a way that neither sparks nor thermic effects (hot surfaces) can cause an ignition.

A safety barrier thus contains three essential elements:

- Zener diodes for limiting the voltage
- Resistor or components for limiting the current
- Fuse for the protection of zener diodes

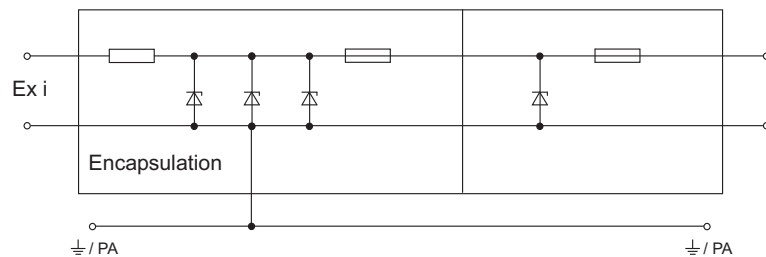

09912E02

R. STAHL safety barriers Series 9001, 9002 and 9004 also contain a protective circuit with an exchangeable fuse externally accessible, protecting the internally encapsulated non-accessible fuses of the safety barrier. The protective circuit prevents both fuses tripping at the same time.

In order to cover the complete spectrum of instrumentation applications a few types of safety barriers include function blocks like e.g. electronic current limitations, amplifier, etc.

Potential Equalisation / Grounding

Differences in potential can delete the intrinsically safety and thus make explosion protection ineffective, since safety barriers have no galvanic isolation between input and output.

All (national) standards for the installation of intrinsically safe circuits thus require:

- the existence of a potential equalisation or grounding system as well as
- the connection of safety barriers to this potential equalisation

R. STAHL safety barriers can alternatively be connected directly via the electrically conducting snap-on mechanism or by means of the \perp / PA-terminal to the potential equalisation.

Selection Criteria - Function and Safety

Selection of safety barriers is generally carried out in two steps:

- Functional consideration
- Safety consideration

1. Functional consideration

Safety barriers are first selected according to their electrical requirements. It is therefore necessary to know the electrical data of the connected apparatus.

Further selection criteria:

- Polarity of the voltage at the safety barrier U_N (+, -, ~) in reference to \neq/PA
- Voltage U_N
- Max. permissible voltage drop across the barrier, caused by the line resistance R_L and / or a constant voltage drop ΔU
- Type of signal to be transmitted; voltage signals can only be transmitted via barriers with purely resistive line resistance; this limitation does not apply to current signals.

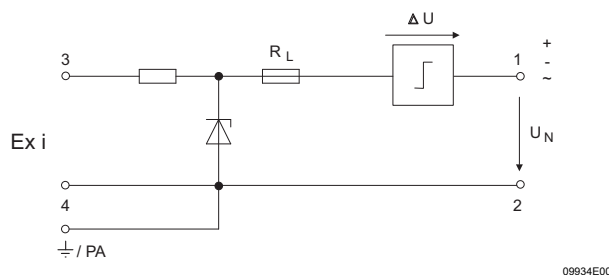

It is furthermore to be examined, if the circuit may be grounded or if an earth-free („floating“) circuit is required due to electrical or measurement reasons.

An earth-free („floating“) circuit can usually be established by using a dual-channel safety barrier or interconnecting two single-channel safety barriers.

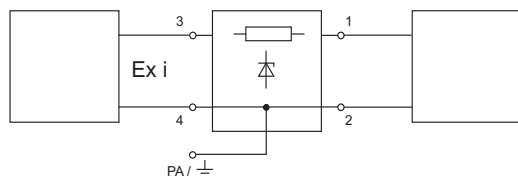

Grounded circuit

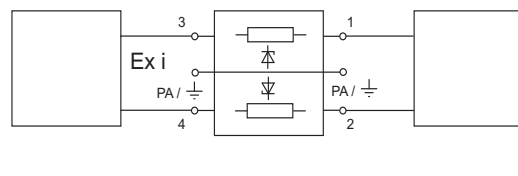

Floating circuit

For many standard application in instrumentation special safety barriers are available, which are designed optimally for the respective application according to the criteria mentioned above.

2. Safety consideration

The safe maximum values of an individual safety barrier (single- or dual-channel) are determined by the certification:

- Maximum voltage U_o
- Maximum current I_o
- Maximum power P_o
- Maximum permissible capacity C_o
- Maximum permissible inductance L_o

It is to be tested however, if the permissible safe maximum values of the intrinsically safe apparatus (field apparatus in the hazardous area) are maintained by the selected safety barrier.

Selection Criteria - Function and Safety

Ex i

$U_o \leq U_i$
 $I_o \leq I_i$
 $P_o \leq P_i$
 $L_o \geq L_i + L_c$
 $C_o \geq C_i + C_c$

09938E00

Interconnection of Safety Barriers

If several safety barriers are interconnected, possible current and / or voltage addition is to be taken into consideration from the safety point of view (example 1 and 2).
The maximum values for U_o and I_o permissible for an interconnection as well as the resulting permissible maximum values for C_o and L_o for the various explosion groups can be referred to in the ignition curves (see EN 60079-11).

Example 1 Interconnection of two safety barriers for positive potential.
From a safety point of view a current addition results, i.e. $I_o = I_{o1} + I_{o2}$
The new voltage U_o is assumed to be the higher of the two values U_{o1} and U_{o2} , thus $U_o = \max. (U_{o1}, U_{o2})$

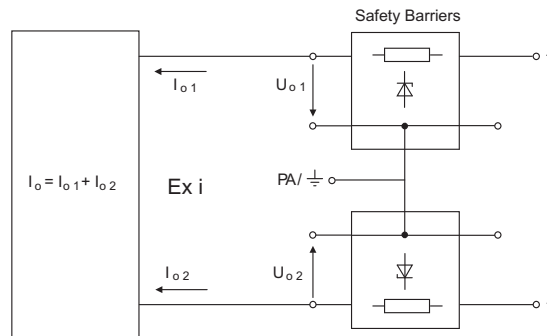

Example 2 Interconnection of two safety barriers for positive and negative potential.
From a safety point of view a voltage addition results, i.e. $U_o = U_{o1} + U_{o2}$
The new current I_o is assumed to be the higher of the two values I_{o1} and I_{o2} , thus $I_o = \max. (I_{o1}, I_{o2})$

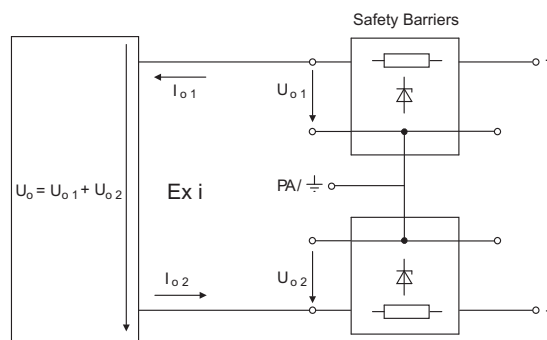

Interconnection of Safety Barriers

Addition possibilities

I = current addition
 U = voltage addition

Example: When interconnecting two safety barriers for alternating potential I + U results, thus a current addition as well as a voltage addition is to be taken into consideration.

Polarity	-	+	~
-	I	U	I and U
+	U	I	I and U
~	I and U	I and U	I and U

The EN 60079-11, table A.1 contains the permissible value pairs / combinations of permissible maximum safe values for:

- Voltage U_o
- Current I_o
- External capacitance C_o

The following procedure is to be applied:

1. Test, if the value combination U_o and I_o determined is permitted

2. Determination of capacitance C_o from voltage U_o

Example 1:

Values 28 V / 100 mA are permitted, since the current I_o can be up to 120 mA at 28 V for explosion group IIC

Example 2:

Values 24 V / 210 mA are permitted only for IIB

Example:

$U_o = 27$ V. For IIB the result is $C_o = 705$ nF

It is not allowed to apply the ignition diagrams acc. to EN 60079-11 for the assessment of the intrinsic safety in case that safety barriers with electronic current limitations need to be interconnected.

A suitable procedure is described in the EN 60079-25.

Installation and Grounding

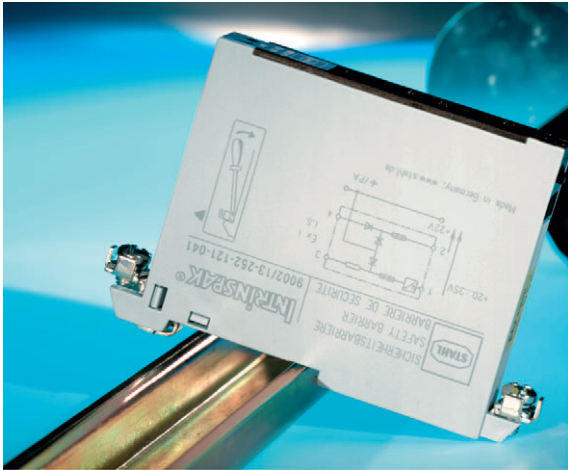

R. STAHL safety barriers Series 9001, 9002 and 9004 excel due to an especially simple mounting mechanism. They snap on to a 35 mm DIN rail (NS35/15) directly without a mounting attachment.

At the same time a conducting connection between \perp / PA of the barrier and the rail, is established. Grounding several barriers is achieved by connecting the rail with the potential equalisation / grounding system (collective ground).

The safety barriers can alternatively be grounded individually as well by using the \perp / PA terminal on the intrinsically safe side of the safety barrier.

A2

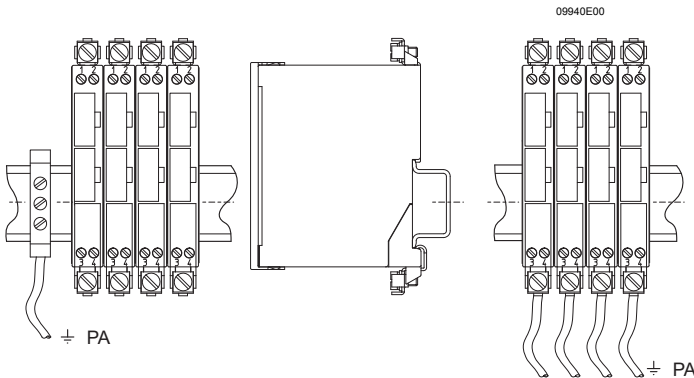

09913E00

Further Mounting Possibilities

Further mounting possibilities result, when using the attachments supplied as accessories. The mounting attachments can be mounted to the barriers by means of an adaptor. (Mounting accessories please find in table Accessories and Spare parts)

	DIN-rail NS35/15	DIN-rail NS32	Mounting plate or flat bar
non isolated			
isolating			<ol style="list-style-type: none"> 1 DIN-rail NS35/15 2 Mounting plate 3 Adaptor Art.Nr. 158826 4 Mounting attachment made of moulded plastic order no. 165283 5 DIN-rail NS32

Safety Barriers

Series 9001 / 9002 / 9004



Exchangeable Back-up Fuse

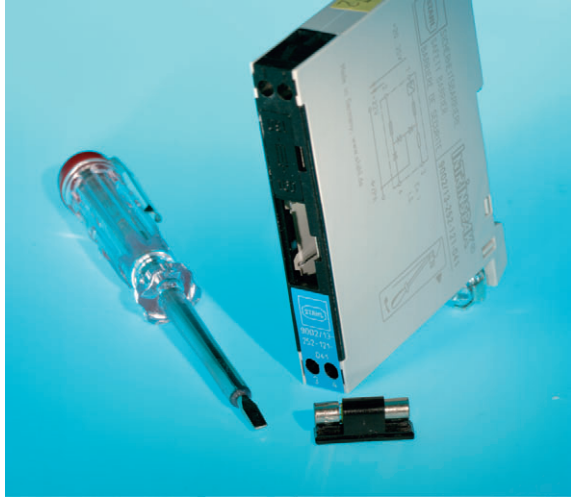

09939E00

All safety barriers Series 9001, 9002 and 9004 have an exchangeable back-up fuse. Dual-channel safety barriers have a back-up fuse per channel. This fuse backs up the internal, non-accessible fuse. A protective circuit prevents tripping of both fuses at the same time. It is thus ensured that the safety barrier is protected against destruction resulting from reverse polarity of the operating voltage or excessively high operation voltages.

Two advantages are essential for maintenance and repair:

- in case of overload the safety barrier does not have to be exchanged, the exchangeable back-up fuse can be replaced without removing the barrier;

The safety barriers and their back-up fuses are designed in such a way that only one back-up fuse (I = 160 mA) can be used for all barriers Series 9001, 9002 and 9004.

Stocking spare parts is thus reduced to an absolute minimum.

Dimensional Drawings (All Dimensions in mm / inches) - Subject to Alterations

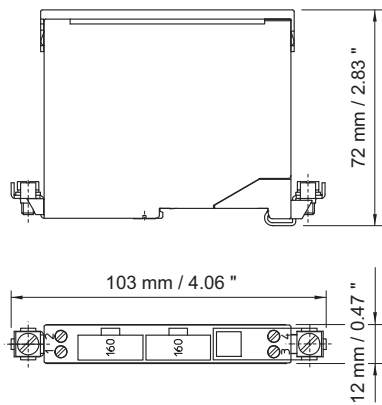

09929E00

Safety barriers 9001, 9002, 9004

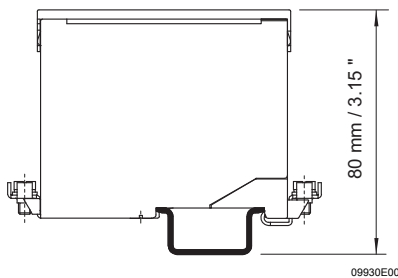

09930E00

Safety barriers 9001, 9002, 9004 mounting on DIN rail NS 35/15

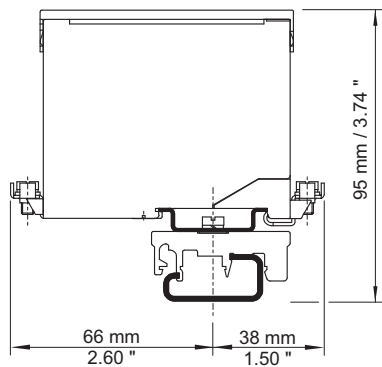

09932E00



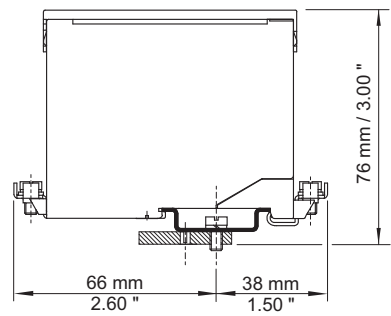



Safety barriers 9001, 9002, 9004 mounting on DIN rail NS 32 by means of adaptor and mounting attachment, moulded plastic



09933E00

Safety barriers 9001, 9002, 9004 mounting on mounting plate by means of adaptor

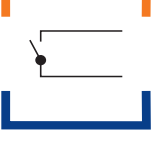
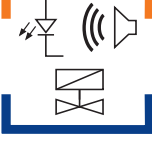
Overview application Safety Barriers

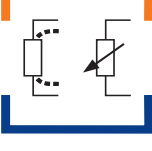



Symbol	Application	INTRINSPAK Type
 06861E00	2-, 3-wire transmitter	9002/13-280-110-001 9001/51-280-091-141
 06329E00	2-wire transmitter HART	9002/13-280-110-001 9001/51-280-091-141
 07648E00	4-wire transmitter, current source Field circuit floating	9002/34-280-000-001
 07650E00	i/p converter, control valve, indicator Field circuit grounded floating	9001/01-280-110-101 9002/13-280-110-001
 06333E00	Contact, optocoupler output Switch (load at +) Field circuit grounded Switch (load grounded) Field circuit grounded	9001/01-252-057-141 9001/01-252-060-141
 06324E00	Solenoid valve, LED indicator Field circuit grounded Field circuit floating	9001/01-252-100-141 9002/13-252-121-041
 06332E00	Thermocouple, mV signals Field circuit floating	9002/77-093-300-001
 06331E00	Resistance thermometer (RTD), Potentiometer Pt100, 2-wire connection Field circuit floating Pt100, 3-wire connection Field circuit floating Pt100, 4-wire connection Field circuit floating	9002/22-032-300-111 9002/22-032-300-111 9001/02-016-150-111 9002/22-032-300-111 9002/77-093-040-001

Safety Barriers

Series 9001 / 9002 / 9004

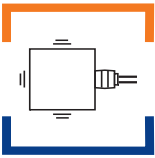

Overview application Safety Barriers

Symbol	Application	INTRINSPAK Type
 <p>07428E00</p>	<p>Strain gauge load cells</p> <p>350 Ω or 700 Ω 6-wire ± 7.5 V (15 V) Field circuit floating</p> <p>350 Ω 6-wire + 10 V Field circuit floating</p> <p>350 Ω or 700 Ω 6-wire + 16 V Field circuit floating</p>	<p>9002/10-187-270-001 9002/10-187-020-001 9002/77-093-040-001</p> <p>9002/11-130-360-001 9002/11-120-024-001 9002/11-120-024-001</p> <p>9002/13-199-225-001 9002/11-199-030-001 9002/11-199-030-001</p>
 <p>06327E00</p>	<p>Fire & gas detection</p>	<p>9001/01-280-165-101</p>
 <p>06892E00</p>	<p>Vibration sensor</p>	<p>9002/00-260-138-001</p>
 <p>06318E00</p>	<p>Intrinsically safe power feed of a load</p>	<p>9004</p>
 <p>06318E00</p>	<p>Intrinsically safe data interface</p>	<p>9002/22-240-160-001</p>