

## Position Switches

Series 8070



www.stahl.de



01617E00

- > Enclosures of type of protection "increased safety"
- > Dimensions and characteristic values according to EN 50041
- > Replaceable contact in flameproof enclosure
- > Positive opening contacts
- > Category 1 safety position switch with a variable system of actuators
- > All inserts may be displaced by 4 x 90°
- > Contacts with:
  - Snap-action contact
  - Slow-action contact
  - Make before break slow-action contact
- > Possible as version with unconnected cable end



E4

Position switches are used to monitor the position of moving parts of machines and systems.

They can be used in safety circuits as the device satisfies the standard EN 60947-5-1 (VDE 0660 Part 200) and the normally closed contacts are positive opening contacts.

The switching element and the actuating element of category 1 safety switches form a constructional and functional unit.

As a result of the galvanic isolation of the moving contacts, the position switch is suitable for switching various potentials.

	ATEX / IECEx					
Zone	0	1	2	20	21	22
For use in		x	x		x	x

WebCode 8070A

# Position Switches

## Series 8070

**Selection Table**

Version	Actuator		Order number	Weight kg
 03788E00	Extended plunger	Plunger of stainless steel	<b>8070/1-.-S</b>	0.155
 03789E00	Roller plunger	Roller of moulded material	<b>8070/1-.-RS</b>	0.154
 04550E00	Roller lever, form E (can be modified into an angled roller lever)	Roller of moulded material	<b>8070/1-.-AR</b>	0.155
 03790E00	Swivelling roller lever, form A	Roller of moulded material	<b>8070/1-.-HR311</b>	0.221
	Swivelling roller lever, form A (swivelling lever of stainless steel)	Roller of moulded material	<b>8070/1-.-HR311NR</b>	0.221
 04551E00	Adjustable roller lever	Roller of moulded material; Roller rod of stainless steel	<b>8070/1-.-HV</b>	0.269
 09380E00	Actuating rod	Rod of moulded material  <b>No positive opening, not suitable for safety circuits!</b>	<b>8070/1-.-HH-K</b>	0.237
 04552E00	Spring-rod actuator	Spring of stainless steel  Only for use with snap-action contact! <b>No positive opening, not suitable for safety circuits!</b>	<b>8070/1-2-F2</b>	0.175
 04553E00	Safety switch	Separate actuator of moulded material	<b>8070/1-1-ZB</b>	0.208
			<b>8070/1-3-ZB</b>	0.208

**Order Number Supplement**

Switching function	1 NC + 1 NO	Slow-action contact	<b>8070/1-1-...</b>	
	2 NC	Slow-action contact	<b>8070/1-3-...</b>	
	2 NO	Slow-action contact	<b>8070/1-4-...</b>	
	1 NC + 1 NO	Slow-action contact, make before break	<b>8070/1-5-...</b>	
	1 NC + 1 NO	Snap-action contact, with spring	<b>8070/1-2-...</b>	
		Possible as version with unconnected cable end	<b>8070/1-.-...-K</b>	

**Note:** The actuators enclosed are not mounted

# Position Switches

## Series 8070



### Explosion Protection

#### Marking

IECEX	
Gas explosion protection	Ex de IIC T6
Dust explosion protection	Ex tD A21 IP65 T80°C
Europe (ATEX)	
Gas explosion protection	⊕ II 2 G Ex de IIC T6
Dust explosion protection	⊕ II 2 D Ex tD A21 IP65 T80°C

#### Certificates

IECEX	
Gas explosion protection	IECEX PTB 06.0092
Dust explosion protection	IECEX PTB 06.0092
Europe (ATEX)	
Gas explosion protection	PTB 01 ATEX 1053
Dust explosion protection	PTB 01 ATEX 1053
Further certificates	China (CQST Ex), India (PESO), Canada (CSA), Kazakhstan (JSC), Korea (KGS), Russia (CTB), Ukraine (IECVE), Belarus (Gospromnadzor)

### Technical Data

#### Electrical Data

Rated operational voltage $U_e$		8070/1-1 8070/1-2 8070/1-5	8070/1-3 8070/1-4
	Alternating current for equal potential: Alternating current for unequal potential: Direct current:	max. 500 V max. 250 V 250 V	max. 400 V max. 250 V 250 V
Rated operational current $I_e$	max. 10 A: $-20\text{ °C} \leq T_a \leq +50\text{ °C}$ max. 6 A: $-20\text{ °C} \leq T_a \leq +70\text{ °C}$		
Switching capacity	AC-12	AC-15	DC-12
	8070/1-1 8070/1-2 8070/1-5	8070/1-3 8070/1-4	8070/1-1 8070/1-2 8070/1-5
	max. 250 V max. 500 V **) max. 10 A max. 5000 VA	max. 250 V max. 400 V **) max. 10 A max. 4000 VA	max. 250 V max. 500 V **) max. 10 A max. 1000 VA
	**) Only for equal potential		
Rated insulation voltage	550 V		
Rated impulse withstand voltage	6 kV		
Short circuit protection	10 A gG		

#### Ambient Conditions

Operating temperature range	-20 ... +50 °C (10 A) -20 ... +70 °C (6 A)
-----------------------------	---

#### Mechanical Data

Degree of protection	IP65
Enclosure material	Polyamide, glass fibre reinforced, black
Maximum switching frequency	max. 6000 operations/h
Mechanical shock resistance	Snap-action contact: 2 g Slow-action contact: 20 g

#### Mounting / Installation

Connection	With cable glands 8161: For plastic sheathed cable 4 x 2.5 mm <sup>2</sup> (diameter 6 ... 13 mm); recommended 4 x 1.5 mm <sup>2</sup> With mounted connecting cable: Plastic sheathed cable HK-SO-X05VV-F-OZ 4 x 1.5 mm, cable length 6 m
Terminals	1 x 2.5 mm <sup>2</sup> or 2 x 1 mm <sup>2</sup> , single-wire / finely-stranded
Cable glands	8161/5-M20-13 On the enclosure bottom: 1 x M20 x 1.5 On the enclosure side: 1 x M20 x 1.5
Tightening torque	Screw terminals: max. 0.4 Nm Cover screws: max. 0.7 Nm Connection thread: 2.3 Nm (M20 x 1.5) Pressure screw: 1.5 Nm (M20 x 1.5)

E4

# Position Switches

## Series 8070

### Technical Data

#### Contact

Version

Slow-action contact

Snap-action contact

Slow-action contact, make before break

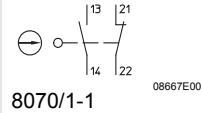

8070/1-1

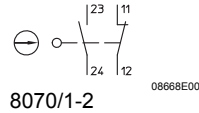

8070/1-2

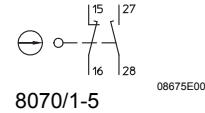

8070/1-5

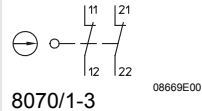

8070/1-3

**Attention:**  
The positive opening function  $\ominus$  depends on the actuator used

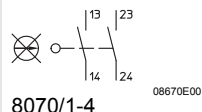

8070/1-4

Contact arrangement

Contact opening

Contacts

Service life

Mechanical

electrical

Enclosure contact

2-pole, galvanically isolated, with double break action

$\geq 1.5$  mm (isolating distance  $\geq 3$  mm)

Silver-nickel

max.  $10^6$  operations

max.  $10^6$  operations

Polyamide, glass fibre reinforced

### Technical Data

Operation, operating speed, contact travel or angle

Actuator	Operation	Diagram	Nominal contact travels or angles	Minimum force/torque
Type 8070/1	<p>V = Max. operating speed</p> <p>→ = Direction of operation</p> <p>() = Connection for device with unconnected cable end</p>	<p><math>\ominus</math> = Positive opening</p>	<p>■ = Contact closed</p> <p>□ = Contact open</p> <p>Zw = Travel for positive opening</p>	
Extended plunger 8070/1- . -S	<p>Lateral operation: V = 0.5 m/s</p> <p>Operation in stroke direction: V = 0.5 m/s</p>		<p>In stroke direction</p> <p><b>8070/1-1:</b></p> <p>Zw = 4.2 mm</p> <p><b>8070/1-2:</b></p> <p>Zw = 4.9 mm</p> <p><b>8070/1-3:</b></p> <p>Zw = 4.6 mm</p> <p><b>8070/1-4:</b></p> <p>Zw = 3.5 mm</p> <p><b>8070/1-5:</b></p> <p>Zw = 4.9 mm</p>	15 N





# Position Switches

## Series 8070

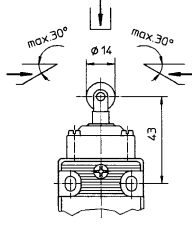
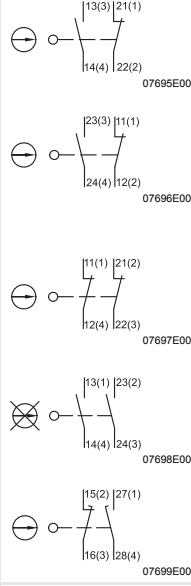
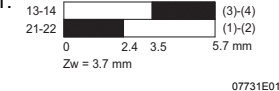
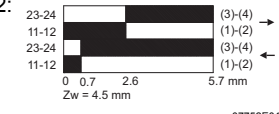
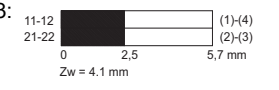
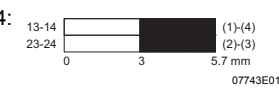
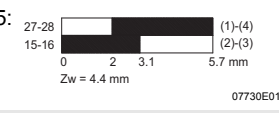
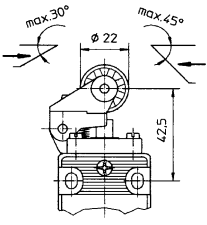
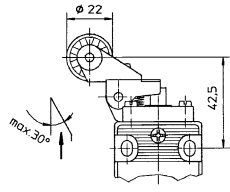
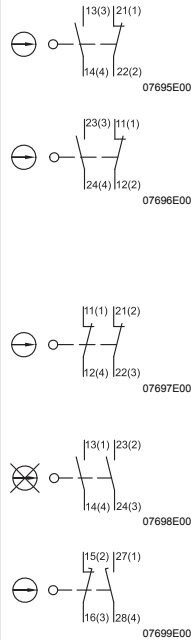
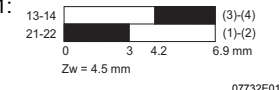
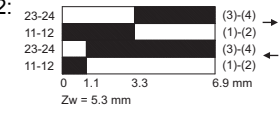

### Technical Data

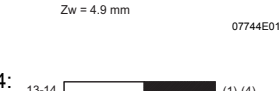
Operation, operating speed, contact travel or angle

Actuator	Operation	Diagram	Nominal contact travels or angles	Minimum force/torque
Type 8070/1	<p>V = Max. operating speed                      → = Direction of operation                      () = Connection for device with unconnected cable end</p>	<p>⊕ = Positive opening</p>	<p>■ = Contact closed                      □ = Contact open                      Zw = Travel for positive opening</p>	
Roller plunger 8070/1- . -RS	 <p>08097E00</p> <p>Lateral operation: V = 0.5 m/s</p> <p>Operation in stroke direction: V = 0.5 m/s</p>		<p>In stroke direction</p> <p>8070/1-1: </p> <p>8070/1-2: </p> <p>8070/1-3: </p> <p>8070/1-4: </p> <p>8070/1-5: </p>	15 N
Roller lever plunger, form E 8070/1- . -AR	 <p>08098E00</p> <p>V = 1,5 m/s</p> <p>Angled roller lever, form E: modified version of 8070/1- . -AR</p>  <p>08665E00</p> <p>Angled roller lever made by rotating the roller lever plunger by 180°</p>		<p>Movement of the roller in stroke direction of the plunger after plunger starts moving</p> <p>8070/1-1: </p> <p>8070/1-2: </p> <p>8070/1-3: </p> <p>8070/1-4: </p> <p>8070/1-5: </p>	13 N







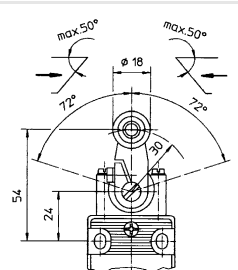
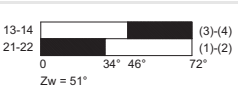

E4

# Position Switches

## Series 8070

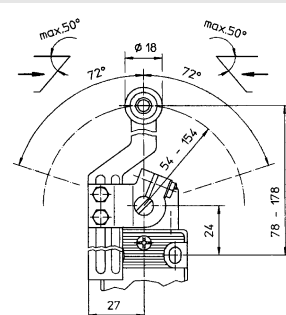
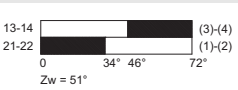
### Technical Data

Operation, operating speed, contact travel or angle

Actuator	Operation	Diagram	Nominal contact travels or angles	Minimum force/torque
Type 8070/1	<p>V = Max. operating speed                      → = Direction of operation                      () = Connection for device with unconnected cable end</p>	<p>⊕ = Positive opening</p>	<p>■ = Contact closed                      □ = Contact open                      Zw = Travel for positive opening</p>	
Swivelling roller lever form A 8070/1- . - HR311..	 <p>V = 1.8 m/s</p>	<p>⊕ 13(3) 21(1) 14(4) 22(2) 07695E00</p> <p>⊕ 23(3) 11(1) 24(4) 12(2) 07696E00</p> <p>⊕ 11(1) 21(2) 12(4) 22(3) 07697E00</p> <p>⊗ 13(1) 23(2) 14(4) 24(3) 07698E00</p> <p>⊕ 15(2) 27(1) 16(3) 28(4) 07699E00</p>	<p><b>8070/1-1:</b></p>  <p>07735E00</p> <p><b>8070/1-2:</b></p>  <p>07749E00</p> <p><b>8070/1-3:</b></p>  <p>07746E00</p> <p><b>8070/1-4:</b></p>  <p>07747E00</p> <p><b>8070/1-5:</b></p>  <p>07734E00</p>	<p>HR311: 0.3 Nm</p> <p>HR311NR: 0.1 Nm</p>
Adjustable roller lever 8070/1- . -HV	 <p>V = 1.4 m/s</p> <p>Should the adjustable roller lever swing back from an angle exceeding 40°, the lever could cause a false signal.</p>	<p>⊕ 13(3) 21(1) 14(4) 22(2) 07695E00</p> <p>⊕ 23(3) 11(1) 24(4) 12(2) 07696E00</p> <p>⊕ 11(1) 21(2) 12(4) 22(3) 07697E00</p> <p>⊗ 13(1) 23(2) 14(4) 24(3) 07698E00</p> <p>⊕ 15(2) 27(1) 16(3) 28(4) 07699E00</p>	<p><b>8070/1-1:</b></p>  <p>07735E00</p> <p><b>8070/1-2:</b></p>  <p>07749E00</p> <p><b>8070/1-3:</b></p>  <p>07746E00</p> <p><b>8070/1-4:</b></p>  <p>07747E00</p> <p><b>8070/1-5:</b></p>  <p>07734E00</p>	<p>0.3 Nm</p>





# Position Switches

## Series 8070

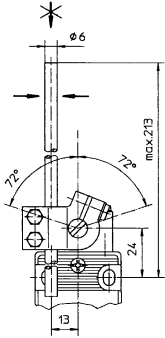
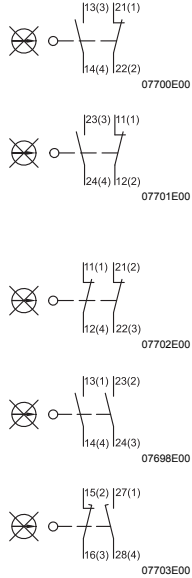
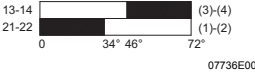
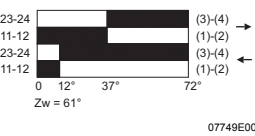
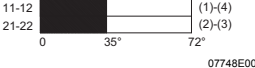

### Technical Data

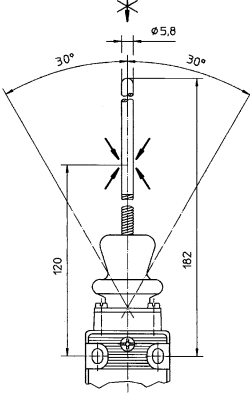
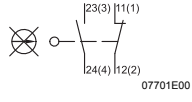
Operation, operating speed, contact travel or angle

Actuator	Operation	Diagram	Nominal contact travels or angles	Minimum force/torque
Type 8070/1	<p>V = Max. operating speed                      → = Direction of operation                      () = Connection for device with unconnected cable end</p>	<p>⊕ = Positive opening</p>	<p>■ = Contact closed                      □ = Contact open                      Zw = Travel for positive opening</p>	
Actuating rod 8070/1- . . - HH-K	 <p>V = 1.4 m/s</p> <p>No positive opening, not suitable for safety circuits</p>		<p>8070/1-1:  07736E00</p> <p>8070/1-2:  07749E00</p> <p>8070/1-3:  07748E00</p> <p>8070/1-4:  07747E00</p> <p>8070/1-5:  07737E00</p>	0.3 Nm
Spring-rod actuator 8070/1-2-F2	 <p>No positive opening, not suitable for safety circuits</p>		<p>Only for use with snap-action contact!</p> <p>8070/1-2:  07753E00</p>	--

E4

# Position Switches

## Series 8070

### Technical Data

Operation, operating speed, contact travel or angle

Actuator	Operation	Diagram	Nominal contact travels or angles	Minimum force/torque
Type 8070/1	V = Max. operating speed → = Direction of operation () = Connection for device with unconnected cable end	⊖ = Positive opening	■ = Contact closed □ = Contact open Zw = Travel for positive opening	
Safety switch with separate actuator 8070/1- . -ZB			<p><b>8070/1-1:</b></p> <p><b>8070/1-3:</b></p>	--
Do not use the switch as a mechanical stop.				
The actuators can be mounted in several ways, this substantially increases the range of application of the switches.				

We reserve the right to make alterations to the technical data, dimensions, weights, designs and products available without notice. The illustrations cannot be considered binding.











## Position Switches

### Series 8070



#### Accessories and Spare Parts

Designation	Illustration	Description	Art. no.	Weight kg		
Actuator	 05652E00	Extended plunger	8070/1-0-S	<b>131805</b>	0.044	
	 05653E00	Roller plunger	8070/1-0-RS	<b>131809</b>	0.042	
	 05653E00	Roller lever, form E (can be modified into an angled roller lever)	8070/1-0-AR	<b>131812</b>	0.046	
	 05655E00	Swivelling roller lever, form A	8070/1-0-HR311	<b>131815</b>	0.099	
		Swivelling roller lever, form A (swivelling lever of stainless steel)	8070/1-0-HR311NR	<b>131841</b>	0.099	
	 05656E00	Adjustable roller lever	8070/1-0-HV	<b>131818</b>	0.148	
	 05657E00	Actuating rod	8070/1-0-HH-K	<b>131821</b>	0.162	
	 05658E00	Spring-rod actuator <b>Only for use with snap-action contact!</b>	8070/1-0-F2	<b>131824</b>	0.059	
		Safety switch with separate actuator (safety operating head)	8070/1-0-ZB	<b>131832</b>	0.071	
		Safety switch with separate actuator (actuating element)	8070/1-0-ZB	<b>131835</b>	0.039	
Cable gland	 05864E00	8161/5-M20-13	1 piece	<b>138518</b>	0.012	
Contact	 10809E00	1 NC + 1 NO	Slow-action contact	8080/1-1	<b>132529</b>	0.025
		2 NC	Slow-action contact	8080/1-3	<b>132532</b>	0.025
		2 NO	Slow-action contact	8080/1-4	<b>132533</b>	0.025
		1 NC + 1 NO	Slow-action contact, make before break	8080/1-5	<b>132534</b>	0.025
		1 NC + 1 NO	Snap-action contact, with spring	8080/1-2	<b>132530</b>	0.025

E4

# Position Switches

## Series 8070

### Dimensional Drawings (All Dimensions in mm) - Subject to Alterations

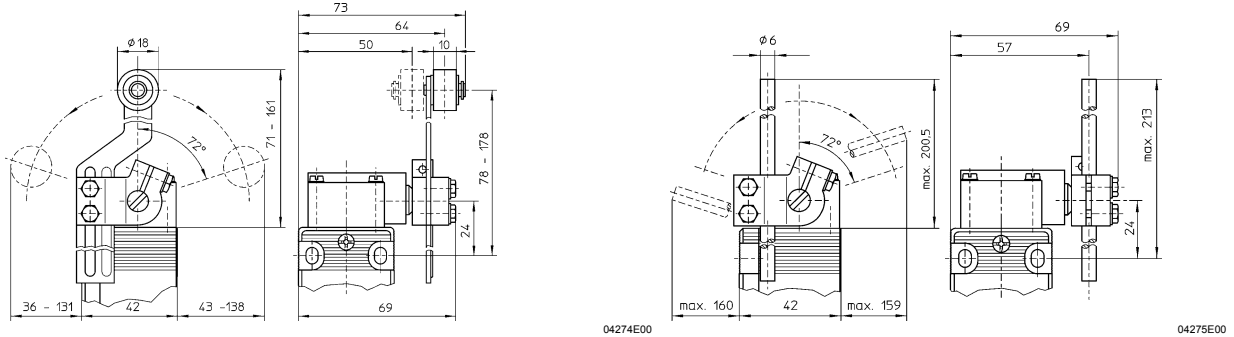

**8070/1- -HV**  
Adjustable roller lever

**8070/1- -HH-K**  
Actuating rod

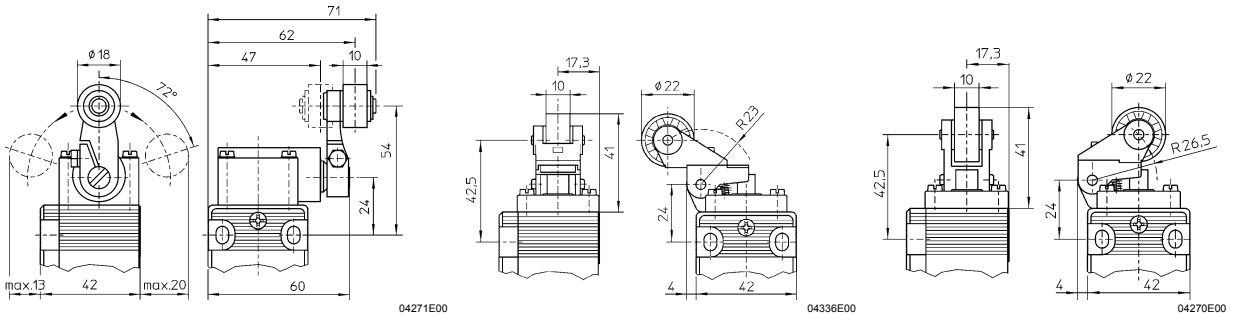

**8070/1- -HR311..**  
Swivelling roller lever, form A

**8070/1- -AR**  
Angled roller lever, form E

**8070/1- -AR**  
Roller lever, form E

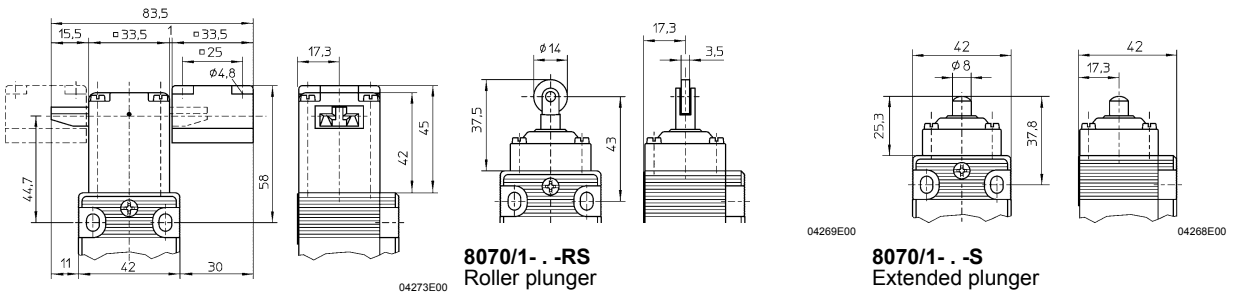

**8070/1- -RS**  
Roller plunger

**8070/1- -S**  
Extended plunger

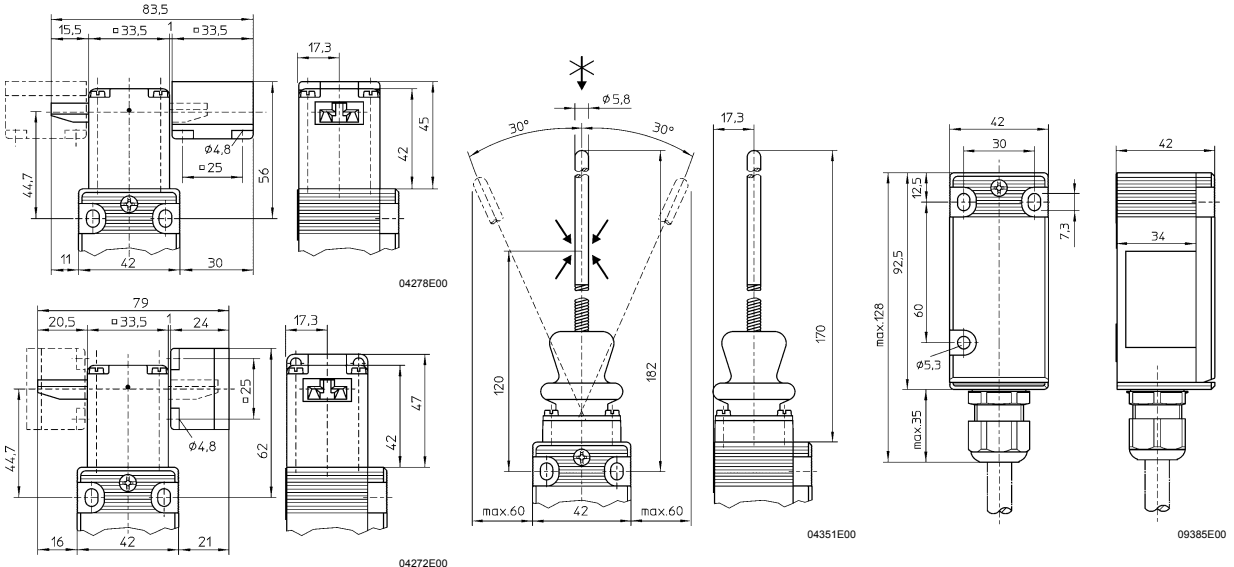

**8070/1- -ZB**  
Safety switch with separate actuator

**8070/1- 2 -F2**  
Spring rod actuator

**8070/1- -OV**  
Position switch without insert