



- Can be used universally for 2- and 3-wire transmitters and mA sources (4-wire transmitters)
- High accuracy
- For use up to SIL 2, special variant up to SIL 3 (IEC/EN 61508)

A3

## MY R. STAHL 9160A



Series 9160 Ex i transmitter supply units are used for the intrinsically safe operation of 2- and 3-wire transmitters or intrinsically safe mA sources such as 4-wire transmitters. The device transmits HART signals in both directions. The range includes one- and two-channel devices, as well as a variant for signal duplication. Special versions are available for lower output voltages and SIL 3.

	IECEx / ATEX					
Zone	0	1	2	20	21	22
Ex interface	•	•	•	•	•	•
Installation in			•			

	NEC® 500 CE Code Appendix J					
	Class I		Class II		Class III	
Division	1	2	1	2	1	2
Ex interface	•	•	•	•	•	•
Installation in		•				

	CE Code Section 18					
	NEC® 505			NEC® 506		
Zone	Class I			20	21	22
Ex interface	0	1	2			
Ex interface	•	•	•			
Installation in			•			

Selection Table									
Product variant		Transmitter supply unit							
Number of channels	Input	Output A	Output B	LFD relay	SIL	Connection type	Product Type	Art. No.	Weight
1	0/4 ... 20 mA with HART	0/4 to 20 mA	-	Yes	2	Screw terminal	9160/13-11-11s	214895	195 g
		0/4 to 20 mA	-	Yes	2	Spring clamp terminal	9160/13-11-11k	214896	195 g
		0/4 to 20 mA	-	Yes	3	Screw terminal	9160/13-11-13s	214897	195 g
		0/4 to 20 mA	-	Yes	3	Spring clamp terminal	9160/13-11-13k	214898	195 g
		0/4 to 20 mA	0/4 to 20 mA (without HART)	Yes	2	Screw terminal	9160/19-11-11s	220324	195 g
		0/4 to 20 mA	0/4 to 20 mA (without HART)	Yes	2	Spring clamp terminal	9160/19-11-11k	220325	195 g
2	0/4 ... 20 mA with HART	Passive	Passive	No	2	Screw terminal	9160/23-10-10s	214903	195 g
		Passive	Passive	No	2	Spring clamp terminal	9160/23-10-10k	214904	195 g
		0/4 to 20 mA	0/4 to 20 mA	Yes	2	Screw terminal	9160/23-11-11s	220322	200 g
		0/4 to 20 mA	0/4 to 20 mA	Yes	2	Spring clamp terminal	9160/23-11-11k	220323	210 g

LFD – line fault diagnostics  
 No – device transmits field-side line faults via a 4 to 20 mA signal. Without LED/relay contact  
 Yes – device transmits field-side line faults via a 4 to 20 mA signal. With LED/relay contact.

**Technical Data**

Variant	9160/...-11-11 9160/13-11-13	9160/23-10-10
<b>Explosion Protection</b>		
IECEX gas explosion protection	Ex nA nC [ia Ga] IIC T4 Gc	Ex nA [ia Ga] IIC T4 Gc
IECEX dust explosion protection	[Ex ia Da] IIIC	[Ex ia Da] IIIC
IECEX firedamp protection	[Ex ia Ma] I	[Ex ia Ma] I
ATEX gas explosion protection	Ⓔ II 3 (1) G Ex nA nC [ia Ga] IIC T4 Gc	Ⓔ II 3 (1) G Ex nA [ia Ga] IIC T4 Gc
ATEX dust explosion protection	Ⓔ II (1) D [Ex ia Da] IIIC	Ⓔ II (1) D [Ex ia Da] IIIC
ATEX firedamp protection	Ⓔ I (M1) [Ex ia Ma] I	Ⓔ I (M1) [Ex ia Ma] I
Certificates	ATEX (BVS), Brazil (ULB), Canada (FM), China (NEPSI), IECEx (BVS), Korea (KTL), SIL (exida), USA (FM)	ATEX (BVS), Brazil (ULB), Canada (FM), China (NEPSI), IECEx (BVS), Korea (KTL), SIL (exida), USA (FM)
Ship approval	CCS, EU RO MR (DNV)	CCS, EU RO MR (DNV)
Declaration of Conformity	ATEX (EUK), China (CCC)	ATEX (EUK), China (CCC)
<b>Auxiliary Power</b>		
Auxiliary power	24 V DC	24 V DC
<b>Input</b>		
Input signal	0/4 to 20 mA with HART	0/4 to 20 mA with HART
Ex i input supply voltage for transmitter	16 V at 20 mA (for 2-wire)	16 V at 20 mA (for 2-wire)
Supply voltage for transmitter	≥ 16 V at 20 mA	≥ 16 V at 20 mA
<b>Output</b>		
Output	0/4 to 20 mA with HART	Passive with HART
Load resistance $R_L$	0 to 600 $\Omega$ (terminal 1+/2- or 5+/6-) 0 to 379 $\Omega$ (terminal 3+/2- or 4+/6-) (with internal 221 $\Omega$ resistor for HART)	
Temperature influence error limits	≤ 0.05% / 10 K	≤ 0.05% / 10 K
Deviation	≤ 0,1 %	≤ 0,1 %
<b>Ambient Conditions</b>		
Ambient temperature	-20 °C ... +70 °C (Single device) -20 °C ... +60 °C (Group assembly)	-20 °C ... +70 °C (Single device) -20 °C ... +60 °C (Group assembly)
Storage temperature	-40 °C ... +80 °C	-40 °C ... +80 °C
<b>Mounting / Installation</b>		
Mounting type	DIN rail NS35/15, NS35/7.5	DIN rail NS35/15, NS35/7.5

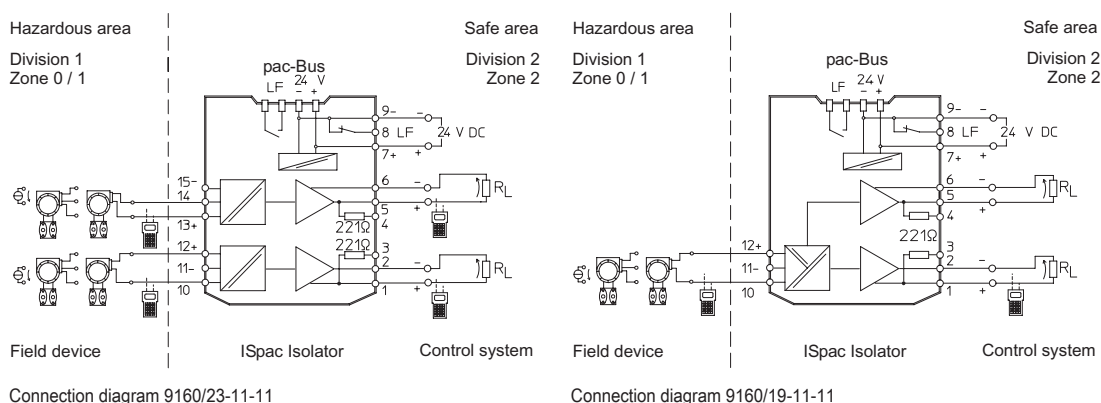
**Technical Drawings – Subject to Alterations**

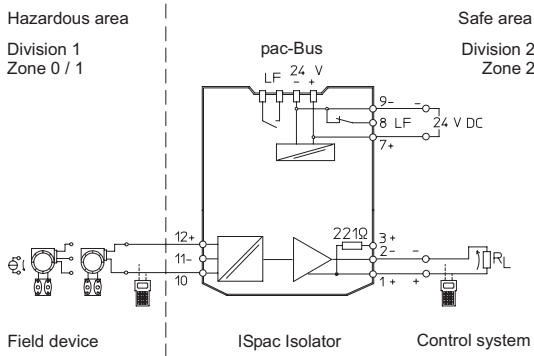

Connection diagram 9160/13-11-13

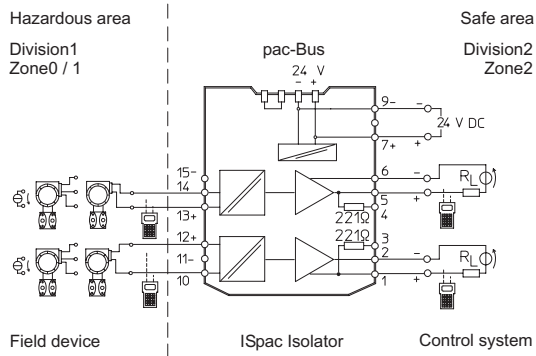

Connection diagram 9160/23-10-10

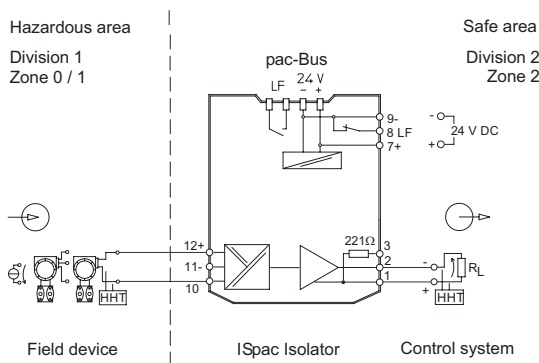





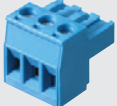

Connection diagram 9160/13-11-11

Accessories			
Figure	Description	Art. No.	Weight
Transparent cover			
	For 91xx ISpac modules Yellow, transparent Clear identification of the device for SIL applications. (Packaging unit: 10 pieces)	200914	20 g
Terminal set for pac-Bus			
	For the supply of 24 V DC auxiliary power via terminals (alternative to using the supply module 9193/21-11-11), with jumper for error message chain for ISpac module 91xx	160730	8 g

Spare Parts			
Figure	Description	Art. No.	Weight
Screw terminal			
	3-pole plug, screw connector thread: M3 stripping length: 7 mm colour: green	112817	5 g
	3-pole plug, screw connector thread: M3 stripping length: 7 mm colour: black	112816	4 g

## Spare Parts

Figure	Description	Art. No.	Weight
<b>Screw terminal</b>			
	3-pole plug, screw connector thread: M3 stripping length: 7 mm colour: blue	112818	5 g
<b>Screw terminal with test tap</b>			
	3-pole plug with test tap, screw connector thread: M3 stripping length: 7 mm colour: black	113005	1 g
	3-pole plug with test tap, screw connector thread: M3 stripping length: 7 mm colour: blue	113004	1 g
<b>Spring clamp terminal</b>			
	3-pole plug with test tap, spring clamp connection stripping length: 10 mm colour: green	112825	5 g
	3-pole plug with test tap, spring clamp connection stripping length: 10 mm colour: black	112824	5 g
	3-pole plug with test tap, spring clamp connection stripping length: 10 mm colour: blue	112826	5 g

## Dimensional Drawings (All Dimensions in mm [inches]) – Subject to Alterations

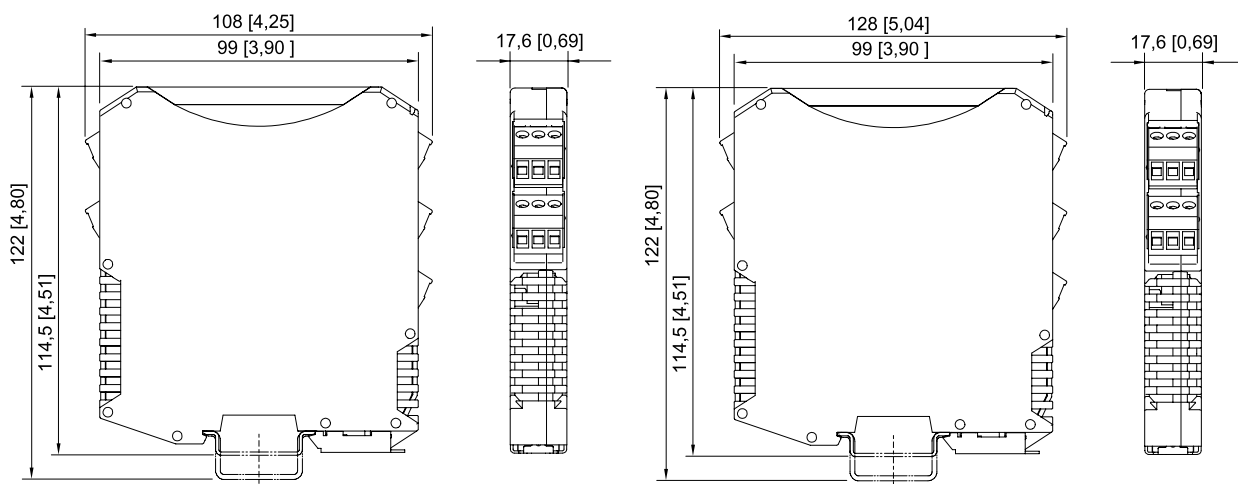

ISpac Series 9143, 9146, 9147, 9160, 9162, 9163, 9165, 9167, 9170, 9172, 9175, 9176, 9180, 9182, 9193, ISbus Series 9412 with screw terminal

ISpac Series 9146, 9147, 9160, 9162, 9163, 9165, 9167, 9170, 9172, 9175, 9176, 9180, 9182, 9193, ISbus Series 9412 with spring clamp terminal

## Load resistance $R_L$

Output version (control)

0/4 to 20 mA passive/sink with HART

A3

Type 9160/...-10-10s

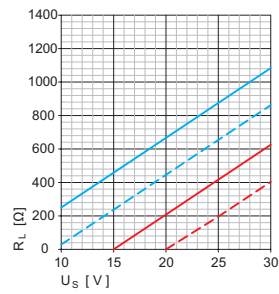

$U_S$  Supply voltage  
 $R_L$  Load resistance  
 $R_{max}$  Max. load resistance at terminals 1, 2 and 5, 6  
 $R_{min}$  Min. load resistance at terminals 1, 2 and 5, 6  
 $R_{max,R}$  Max. load resistance at terminals 1, 3 and 4, 6  
 $R_{min,R}$  Min. load resistance at terminals 1, 3 and 4, 6