



- Lamp: Flashing beacon – XENON (5 J)/continuous beacon – LED (6.5 W)
- Type of protection: Ex d
- Class: IP66/IP67 (IEC 60529/NEMA 4X)
- Corrosion-resistant GRP enclosure
- Including stainless steel protective cage
- Eight light-amplifying Fresnel lens colours can be ordered
- Low weight (2.25 kg)

E5

## MY R. STAHL FX15A



The **FX15 product series** provides visual signals as a continuous beacon with LED or a 5 J flashing beacon with xenon flashes. The enclosure is made from glass fibre reinforced polyester. The product series is intended for use in hazardous and harsh environments.

	IECEX / ATEX					
Zone	0	1	2	20	21	22
Installation in		•	•		•	•

Selection Table					
Lamp	LED				
Lens colour	Rated operational voltage AC	Rated operational voltage DC	Product Type	Art. No.	Weight
Amber	100 ... 254 V	–	FX15/C-P-060-A-EN-SF-A-ST-00-00-00	247077	2.25 kg
	–	21.1 ... 24 V	FX15/21-DH0000-AW0003-ST0000-0000	284502	2.23 kg
Blue	100 ... 254 V	–	FX15/C-P-060-B-EN-SF-A-ST-00-00-00	247069	2.25 kg
	–	24 V	FX15/C-D-060-B-EN-SF-A-ST-00-00-00	247070	2.23 kg
Clear	100 ... 254 V	–	FX15/C-P-060-C-EN-SF-A-ST-00-00-00	247085	2.25 kg
	–	24 V	FX15/C-D-060-C-EN-SF-A-ST-00-00-00	247086	2.23 kg
Green	100 ... 254 V	–	FX15/C-P-060-G-EN-SF-A-ST-00-00-00	247061	2.25 kg
	–	21.1 ... 24 V	FX15/21-DH0000-GW0003-ST0000-0000	309585	2.23 kg
	–	24 V	FX15/C-D-060-G-EN-SF-A-ST-00-00-00	247062	2.23 kg
Magenta	–	24 V	FX15/C-D-060-M-EN-SF-A-ST-00-00-00	251767	2.23 kg
Red	100 ... 254 V	–	FX15/C-P-060-R-EN-SF-A-ST-00-00-00	247093	2.25 kg
	–	21.1 ... 24 V	FX15/21-DH0000-RR0003-ST0000-0000	284501	2.23 kg
Yellow	–	21.1 ... 24 V	FX15/21-DH0000-YW0003-ST0000-0000	284503	2.23 kg

**Selection Table**

Lamp	Xenon flash tubes				
Lens colour	Rated operational voltage AC	Rated operational voltage DC	Product Type	Art. No.	Weight
Amber	115 V	-	FX15/C-L-050-A-EN-SF-A-ST-00-00-00	217981	2.25 kg
	230 V	-	FX15/C-N-050-A-EN-SF-A-ST-00-00-00	217982	2.25 kg
	-	21.1 ... 24 V	FX15/21-D05000-AW0003-ST0000-0000	284504	2.23 kg
		24 V	FX15/C-D-050-A-EN-SF-A-ST-00-00-00	217979	2.23 kg
		48 V	FX15/C-F-050-A-EN-SF-A-ST-00-00-00	217980	2.23 kg
Blue	230 V	-	FX15/C-N-050-B-EN-SF-A-ST-00-00-00	218002	2.25 kg
	-	24 V	FX15/C-D-050-B-EN-SF-A-ST-00-00-00	217992	2.23 kg
		48 V	FX15/C-F-050-B-EN-SF-A-ST-00-00-00	217976	2.23 kg
Clear	115 V	-	FX15/C-L-050-C-EN-SF-A-ST-00-00-00	217983	2.25 kg
	230 V	-	FX15/C-N-050-C-EN-SF-A-ST-00-00-00	217995	2.25 kg
	-	24 V	FX15/C-D-050-C-EN-SF-A-ST-00-00-00	217989	2.23 kg
		48 V	FX15/C-F-050-C-EN-SF-A-ST-00-00-00	217999	2.23 kg
Green	115 V	-	FX15/C-L-050-G-EN-SF-A-ST-00-00-00	217993	2.25 kg
	230 V	-	FX15/C-N-050-G-EN-SF-A-ST-00-00-00	218003	2.25 kg
	-	24 V	FX15/C-D-050-G-EN-SF-A-ST-00-00-00	217997	2.23 kg
		48 V	FX15/C-F-050-G-EN-SF-A-ST-00-00-00	217977	2.23 kg
Red	115 V	-	FX15/C-L-050-R-EN-SF-A-ST-00-00-00	217973	2.25 kg
	230 V	-	FX15/C-N-050-R-EN-SF-A-ST-00-00-00	217974	2.25 kg
	-	21.1 ... 24 V	FX15/21-D05000-RW0003-ST0000-0000	284505	2.23 kg
		24 V	FX15/C-D-050-R-EN-SF-A-ST-00-00-00	217971	2.23 kg
		48 V	FX15/C-F-050-R-EN-SF-A-ST-00-00-00	217972	2.23 kg
Yellow	230 V	-	FX15/C-N-050-Y-EN-SF-A-ST-00-00-00	218001	2.25 kg
	-	21.1 ... 24 V	FX15/21-D05000-YW0003-ST0000-0000	284506	2.23 kg
		24 V	FX15/C-D-050-Y-EN-SF-A-ST-00-00-00	217991	2.23 kg
		48 V	FX15/C-F-050-Y-EN-SF-A-ST-00-00-00	217975	2.23 kg

**Technical Data**





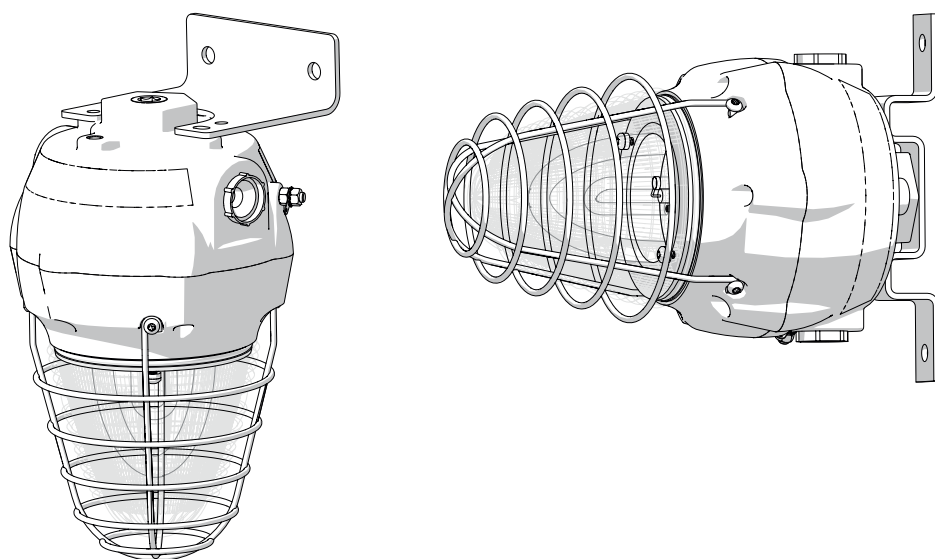

Variant	FX15/21 24 V DC	FX15/C-N 230 V AC	FX15/C-L 115 V AC	FX15/C-F 48 V DC
Explosion Protection				
IECEx gas explosion protection	Ex db IIC T6 / T4 Gb	Ex d IIC T6 ... T4 Gb	Ex d IIC T5 / T4 Gb	Ex d IIC T6 ... T4 Gb
IECEx dust explosion protection	Ex tb IIIC T80 °C / T100 °C Db	Ex tb IIIC T75 °C ... T105 °C Db	Ex tb IIIC T83 °C / T113 °C Db	Ex tb IIIC T73 °C ... T103 °C Db



Technical Data				
Variant	FX15/21 24 V DC	FX15/C-N 230 V AC	FX15/C-L 115 V AC	FX15/C-F 48 V DC
<b>Explosion Protection</b>				
ATEX gas explosion protection	Ⓔ II 2 G Ex db IIC T6 / T4 Gb	Ⓔ II 2 G Ex d IIC T6 ... T4 Gb	Ⓔ II 2 G Ex d IIC T5 / T4 Gb	Ⓔ II 2 G Ex d IIC T6 ... T4 Gb
ATEX dust explosion protection	Ⓔ II 2 D Ex tb IIIC T80 °C / T100 °C Db	Ⓔ II 2 D Ex tb IIIC T75 °C ... T105 °C Db	Ⓔ II 2 D Ex tb IIIC T83 °C / T113 °C Db	Ⓔ II 2 D Ex tb IIIC T73 °C ... T103 °C Db
Certificates	ATEX (BVIS), IECEx (BVIS)	ATEX (BAS), IECEx (BAS)	ATEX (BAS), IECEx (BAS)	ATEX (BAS), IECEx (BAS)
Declaration of Conformity	ATEX (EUK)	ATEX (EUK)	ATEX (EUK)	ATEX (EUK)
<b>Electrical Data</b>				
Tolerance	-10 ... 10 %	-10 ... 10 %	-10 ... 10 %	-10 ... 10 %
<b>Ambient Conditions</b>				
Ambient temperature °C	-60 °C	-60 °C	-60 °C	-60 °C
Ambient temperature	-60 °C ... +50 °C (T6) -60 °C ... +70 °C (T4)	-60 °C ... +40 °C (T6) -60 °C ... +55 °C (T5) -60 °C ... +70 °C (T4)	-60 °C ... +40 °C (T5) -60 °C ... +55 °C (T4)	-60 °C ... +40 °C (T6) -60 °C ... +55 °C (T5) -60 °C ... +70 °C (T4)
Operating temperature		-55 °C ... +70 °C	-55 °C ... +55 °C	-50 °C ... +70 °C
<b>Mechanical Data</b>				
Degree of protection (IP) (IEC 60529)	IP66	IP66/IP67	IP66/IP67	IP66/IP67
Enclosure material	Polyester, Glass fibre reinforced	Polyester (GRP), Glass fibre reinforced	Polyester (GRP), Glass fibre reinforced	Polyester (GRP), Glass fibre reinforced
Enclosure colour	Black	Black	Black	Black
Seal	O-ring seal	O-ring seal	O-ring seal	O-ring seal
Sealing material	Red silicone 70	Red silicone 70	Red silicone 70	Red silicone 70
Material dome	Polycarbonate, prismatic	Polycarbonate, prismatic	Polycarbonate, prismatic	Polycarbonate, prismatic
Wire guard material	Stainless steel	Stainless steel	Stainless steel	Stainless steel
Max. solid connection terminals	2.5 mm <sup>2</sup>	2.5 mm <sup>2</sup>	2.5 mm <sup>2</sup>	2.5 mm <sup>2</sup>
Max. finely stranded connection terminals	2.5 mm <sup>2</sup>	2.5 mm <sup>2</sup>	2.5 mm <sup>2</sup>	2.5 mm <sup>2</sup>
<b>Mounting / Installation</b>				
Mounting part material	Stainless steel	Stainless steel	Stainless steel	Stainless steel
Note about mounting	Can be ordered as accessories	Can be ordered as accessories	Can be ordered as accessories	Can be ordered as accessories
Connection type	Push in	Screw terminal	Screw terminal	Screw terminal
<b>Components</b>				
Drilled holes	3 x M20	3 x M20	3 x M20	3 x M20
Cable glands and entries	Can be ordered as accessories	Can be ordered as accessories	Can be ordered as accessories	Can be ordered as accessories
Stopping plugs	3 x dust cap	3 x dust cap	3 x dust cap	3 x dust cap

You can find more technical data online at [r-stahl.com](http://r-stahl.com). MY R. STAHL FX15A

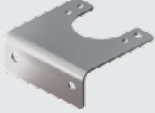
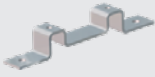
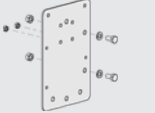

## Accessories

Figure	Description	Art. No.	Weight
<b>Metal cable gland</b>			
	Ex d and Ex e cable gland with compound for all types of armoured cables (SWA, wire-braid, tape) (nickel-plated brass) Type 20PX2K, M20 x 1.5	109428	240 g
	Ex d and Ex e cable glands with RapidEx sealing system for all types of unarmoured cables and wire-braid-armoured cables (nickel-plated brass) Type 20PX2K-REX, M20 x 1.5	246649	240 g
	Ex d and Ex e cable glands with compound for all types of unarmoured cables and wire-braid-armoured cables (nickel-plated brass) Type 20PXSS2K, M20 x 1.5	109441	200 g
	Ex d and Ex e cable glands with RapidEx sealing system for all types of unarmoured cables and wire-braid-armoured cables (nickel-plated brass) Type 20PXSS2K-REX, M20 x 1.5	246605	200 g
	Ex d and Ex e cable gland for all types of unarmoured cables (SWA, wire-braid, tape) (nickel-plated brass) with a special compensating sliding seal (CDS) Type 20T3CDS, M20 x 1.5	246561	280 g
<b>Stopping plug</b>			
	Stainless steel stopping plug M20x1.5 with hexagon insert bit	251101	79 g

Accessories			
Figure	Description	Art. No.	Weight
<b>Mounting accessories</b>			
	Stainless steel L-bracket, standard version	221711	287 g
	Stainless steel L-bracket, long version	247371	280 g
	Stainless steel fastening bracket	221712	155 g
	Adapter plate for pipe clamp fastening	256519	630 g
	Stainless steel sun shield	262077	200 g
	Pipe clamp, R 1 1/4"	120812	500 g
	Pipe clamp, R 1 1/2"	120819	470 g
	Pipe clamp, R 2"	120823	500 g

Spare Parts			
Figure	Description	Art. No.	Weight
<b>Fresnel lens</b>			
	Fresnel lens, amber, spare	292060	180 g
	Fresnel lens, blue, spare	292141	180 g
	Fresnel lens, green, spare	292143	180 g
	Fresnel lens, clear, spare	292144	180 g
	Fresnel lens, red, spare	292147	180 g
	Fresnel lens, yellow, spare	292142	180 g
	Fresnel lens, magenta	292145	180 g
<b>PCB</b>			
	Connection PCB	223579	20 g
	Electronic PCB, 24 V DC, 5 J (available for FL6S, FX15, YL6S)	223635	80 g
	Electronic PCB, 115 V AC, 5 joules	223632	118 g
	Electronic PCB, 230 V AC, 5 Joule	223580	100 g
<b>Lamp</b>			
	Xenon lamp	223636	6 g

☐ FX15 flashing beacons are supplied without a bracket. These must be ordered separately (see accessories table).

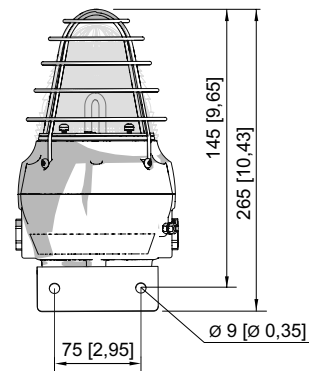
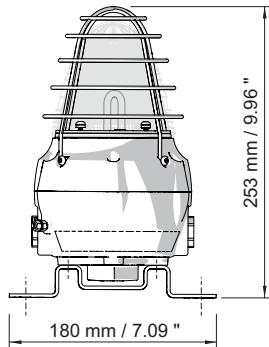
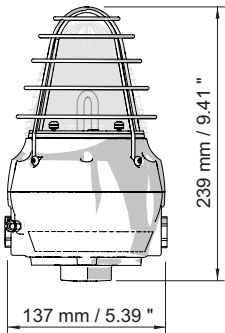
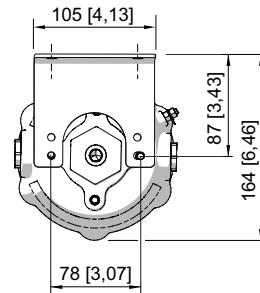
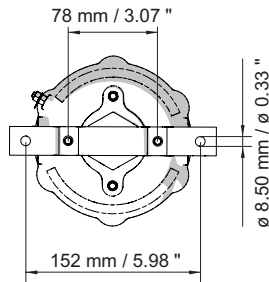
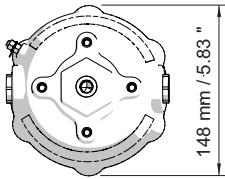

FX15 flashing beacon

FX15 flashing beacon with fastening bracket

FX15 flashing beacon with L-bracket

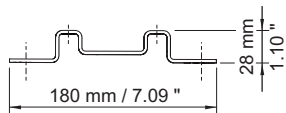
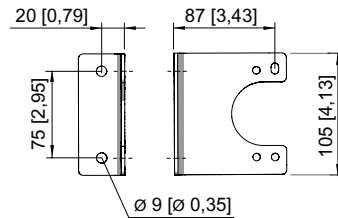
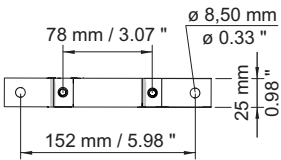

L-bracket

Fastening bracket