

- Isolation function in accordance with EN60947-2
- Energy limitation class 3
- Simple replacement or expansion of your system thanks to a modular circuit breaker design
- Simple installation – it snaps onto the mounting rail in Ex e enclosures
- Non-adjustable thermal and magnetic releases
- Ergonomically shaped operating lever guarantees that the system can be switched on and off safely
- Padlocks (Accessories) provide protection against being switched on again during maintenance work

09

MY R. STAHL 8530A



R. STAHL 8530 series miniature circuit breakers are overcurrent devices that also provide good current limiting for short circuits and a high switching capacity of 10, 15 or 25 kA. This results in a low load on cables and a high selectivity for upstream fuses. The components have a modular design and are therefore available in 1- to 4-pole versions and for rated currents of 0.5-63 A. The maximum installation capacity is 4.5 subunits.

	IECEX / ATEX					
Zone	0	1	2	20	21	22
Installation in		•	•			

Selection Table						
Product variant			with auxiliary contacts			
No. of poles			1-pole			
1st auxiliary function			Auxiliary contact 1 change-over contact + fault signal contact 1 change-over contact			
2nd auxiliary function			without			
Rated operational voltage AC			230 V			
Rated operational current	Tripping characteristic	Electrical service life	Product Type	Art. No.	Weight	
0.5 A	C	2 x 10 ⁴	8530/1-MCB-STA101-C0,5-500-2	293987	1 kg	
6 A	B	2 x 10 ⁴	8530/1-MCB-STA101-B6-500-2	293976	1 kg	
	C	2 x 10 ⁴	8530/1-MCB-STA101-C6-500-2	293994	1 kg	
10 A	B	2 x 10 ⁴	8530/1-MCB-STA101-B10-500-2	293977	1 kg	
	C	2 x 10 ⁴	8530/1-MCB-STA101-C10-500-2	293995	1 kg	
13 A	B	2 x 10 ⁴	8530/1-MCB-STA101-B13-500-2	293978	1 kg	
	C	2 x 10 ⁴	8530/1-MCB-STA101-C13-500-2	293996	1 kg	
16 A	B	2 x 10 ⁴	8530/1-MCB-STA101-B16-500-2	293980	1 kg	
	C	2 x 10 ⁴	8530/1-MCB-STA101-C16-500-2	293997	1 kg	
20 A	B	2 x 10 ⁴	8530/1-MCB-STA101-B20-500-2	293983	1 kg	
	C	2 x 10 ⁴	8530/1-MCB-STA101-C20-500-2	293999	1 kg	
32 A	B	10 ⁴	8530/1-MCB-STA101-B32-500-2	293985	1 kg	
	C	10 ⁴	8530/1-MCB-STA101-C32-500-2	294002	1 kg	
40 A	B	10 ⁴	8530/1-MCB-STA101-B40-500-2	293986	1 kg	
	C	10 ⁴	8530/1-MCB-STA101-C40-500-2	294003	1 kg	

Selection Table

Product variant		with auxiliary contacts			
No. of poles		2-pole			
1st auxiliary function		Auxiliary contact 1 change-over contact + fault signal contact 1 change-over contact			
2nd auxiliary function		without			
Rated operational voltage AC		230/400 V			
Rated operational current	Tripping characteristic	Electrical service life	Product Type	Art. No.	Weight
0.5 A	C	2 x 10 ⁴	8530/1-MCB-STA102-C0,5-500-3	267202	1.3 kg
1 A	C	2 x 10 ⁴	8530/1-MCB-STA102-C1-500-3	267203	1.3 kg
2 A	C	2 x 10 ⁴	8530/1-MCB-STA102-C2-500-3	272131	1.3 kg
	Z	2 x 10 ⁴	8530/1-MCB-STA102-Z2-500-3	299280	1.3 kg
6 A	B	2 x 10 ⁴	8530/1-MCB-STA102-B6-500-3	272123	1.3 kg
	C	2 x 10 ⁴	8530/1-MCB-STA102-C6-500-3	272134	1.3 kg
	Z	2 x 10 ⁴	8530/1-MCB-STA102-Z6-500-3	318132	1.3 kg
16 A	B	2 x 10 ⁴	8530/1-MCB-STA102-B16-500-3	272126	1.3 kg
	C	2 x 10 ⁴	8530/1-MCB-STA102-C16-500-3	272137	1.3 kg
25 A	B	2 x 10 ⁴	8530/1-MCB-STA102-B25-500-3	272128	1.3 kg
	C	2 x 10 ⁴	8530/1-MCB-STA102-C25-500-3	267212	1.3 kg
32 A	B	10 ⁴	8530/1-MCB-STA102-B32-500-3	272129	1.3 kg
	C	10 ⁴	8530/1-MCB-STA102-C32-500-3	272139	1.3 kg
40 A	B	10 ⁴	8530/1-MCB-STA102-B40-500-3	272130	1.3 kg
	C	10 ⁴	8530/1-MCB-STA102-C40-500-3	272140	1.3 kg

Product variant		with auxiliary contacts			
No. of poles		2-pole			
1st auxiliary function		Auxiliary contact 1 change-over contact + fault signal contact 1 change-over contact			
2nd auxiliary function		without			
Rated operational voltage AC		400 V			
Rated operational voltage DC		125 V			
Rated operational current	Tripping characteristic	Electrical service life	Product Type	Art. No.	Weight
1 A	C	2 x 10 ⁴	8530/1-MCB-DCA102-C1-500-3	304225	1.3 kg
2 A	C	2 x 10 ⁴	8530/1-MCB-DCA102-C2-500-3	304226	1.3 kg
16 A	C	2 x 10 ⁴	8530/1-MCB-DCA102-C16-500-3	301431	1.3 kg
32 A	C	10 ⁴	8530/1-MCB-DCA102-C32-500-3	304234	1.3 kg

Product variant		with auxiliary contacts			
No. of poles		3-pole			
1st auxiliary function		Auxiliary contact 1 change-over contact + fault signal contact 1 change-over contact			
2nd auxiliary function		without			
Rated operational voltage AC		230/400 V			
Rated operational current	Tripping characteristic	Electrical service life	Product Type	Art. No.	Weight
16 A	B	2 x 10 ⁴	8530/1-MCB-STA103-B16-500-4	293886	1.8 kg
	C	2 x 10 ⁴	8530/1-MCB-STA103-C16-500-4	293900	1.8 kg
20 A	B	2 x 10 ⁴	8530/1-MCB-STA103-B20-500-4	293887	1.8 kg
	C	2 x 10 ⁴	8530/1-MCB-STA103-C20-500-4	293901	1.8 kg
25 A	B	2 x 10 ⁴	8530/1-MCB-STA103-B25-500-4	293888	1.8 kg
	C	2 x 10 ⁴	8530/1-MCB-STA103-C25-500-4	293902	1.8 kg
32 A	B	10 ⁴	8530/1-MCB-STA103-B32-500-4	293889	1.8 kg
	C	10 ⁴	8530/1-MCB-STA103-C32-500-4	293903	1.8 kg
40 A	B	10 ⁴	8530/1-MCB-STA103-B40-500-4	293890	1.8 kg
	C	10 ⁴	8530/1-MCB-STA103-C40-500-4	293904	1.8 kg
50 A	B	10 ⁴	8530/1-MCB-STA103-B50-500-4	293891	1.8 kg
	C	10 ⁴	8530/1-MCB-STA103-C50-500-4	293905	1.8 kg

Selection Table					
Product variant		with auxiliary contacts			
No. of poles		3-pole			
1st auxiliary function		Auxiliary contact 1 change-over contact + fault signal contact 1 change-over contact			
2nd auxiliary function		without			
Rated operational voltage AC		230/400 V			
Rated operational current	Tripping characteristic	Electrical service life	Product Type	Art. No.	Weight
63 A	B	10 ⁴	8530/1-MCB-STA103-B63-500-4	293892	1.8 kg
	C	10 ⁴	8530/1-MCB-STA103-C63-500-4	293906	1.8 kg
Product variant		with auxiliary contacts			
No. of poles		3-pole + N			
1st auxiliary function		Auxiliary contact 1 change-over contact			
2nd auxiliary function		without			
Rated operational voltage AC		230/400 V			
Rated operational current	Tripping characteristic	Electrical service life	Product Type	Art. No.	Weight
6 A	B	2 x 10 ⁴	8530/1-MCB-STA103N-B6-100-4	293863	1.8 kg
	C	2 x 10 ⁴	8530/1-MCB-STA103N-C6-100-4	293873	1.8 kg
16 A	B	2 x 10 ⁴	8530/1-MCB-STA103N-B16-100-4	293866	1.8 kg
	C	2 x 10 ⁴	8530/1-MCB-STA103N-C16-100-4	293876	1.8 kg
20 A	B	2 x 10 ⁴	8530/1-MCB-STA103N-B20-100-4	293867	1.8 kg
	C	2 x 10 ⁴	8530/1-MCB-STA103N-C20-100-4	293877	1.8 kg
25 A	B	2 x 10 ⁴	8530/1-MCB-STA103N-B25-100-4	293868	1.8 kg
	C	2 x 10 ⁴	8530/1-MCB-STA103N-C25-100-4	293878	1.8 kg
32 A	B	10 ⁴	8530/1-MCB-STA103N-B32-100-4	293869	1.8 kg
	C	10 ⁴	8530/1-MCB-STA103N-C32-100-4	293879	1.8 kg
63 A	B	10 ⁴	8530/1-MCB-STA103N-B63-100-4	293872	1.8 kg
	C	10 ⁴	8530/1-MCB-STA103N-C63-100-4	293882	1.8 kg
Product variant		without auxiliary contacts			
No. of poles		2-pole			
1st auxiliary function		without			
2nd auxiliary function		without			
Rated operational voltage AC		230/400 V			
Rated operational current	Tripping characteristic	Electrical service life	Product Type	Art. No.	Weight
0.5 A	C	2 x 10 ⁴	8530/1-MCB-STA102-C0,5-000-2	293963	1 kg
10 A	B	2 x 10 ⁴	8530/1-MCB-STA102-B10-000-2	293915	1 kg
	C	2 x 10 ⁴	8530/1-MCB-STA102-C10-000-2	293969	1 kg
16 A	B	2 x 10 ⁴	8530/1-MCB-STA102-B16-000-2	293918	1 kg
	C	2 x 10 ⁴	8530/1-MCB-STA102-C16-000-2	293971	1 kg
20 A	B	2 x 10 ⁴	8530/1-MCB-STA102-B20-000-2	293919	1 kg
	C	2 x 10 ⁴	8530/1-MCB-STA102-C20-000-2	293972	1 kg
25 A	B	2 x 10 ⁴	8530/1-MCB-STA102-B25-000-2	293920	1 kg
	C	2 x 10 ⁴	8530/1-MCB-STA102-C25-000-2	293973	1 kg
32 A	B	10 ⁴	8530/1-MCB-STA102-B32-000-2	293961	1 kg
	C	10 ⁴	8530/1-MCB-STA102-C32-000-2	293974	1 kg
40 A	B	10 ⁴	8530/1-MCB-STA102-B40-000-2	293962	1 kg
	C	10 ⁴	8530/1-MCB-STA102-C40-000-2	293975	1 kg

Selection Table

Product variant		without auxiliary contacts			
No. of poles		3-pole			
1st auxiliary function		without			
2nd auxiliary function		without			
Rated operational voltage AC		230/400 V			
Rated operational current	Tripping characteristic	Electrical service life	Product Type	Art. No.	Weight
6 A	B	2 x 10 ⁴	8530/1-MCB-STA103-B6-000-3	272160	1.4 kg
	C	2 x 10 ⁴	8530/1-MCB-STA103-C6-000-3	272175	1.4 kg
10 A	B	2 x 10 ⁴	8530/1-MCB-STA103-B10-000-3	272161	1.4 kg
	C	2 x 10 ⁴	8530/1-MCB-STA103-C10-000-3	272176	1.4 kg
	D	2 x 10 ⁴	8530/1-MCB-STS103-D10-000-3	291241	1.4 kg
	D	2 x 10 ⁴	8530/1-MCB-STS103-D25-000-3	291242	1.4 kg
	D	10 ⁴	8530/1-MCB-STS103-D32-000-3	291243	1.4 kg
16 A	B	2 x 10 ⁴	8530/1-MCB-STA103-B16-000-3	272163	1.4 kg
	C	2 x 10 ⁴	8530/1-MCB-STA103-C16-000-3	272178	1.4 kg
20 A	B	2 x 10 ⁴	8530/1-MCB-STA103-B20-000-3	272164	1.4 kg
25 A	B	2 x 10 ⁴	8530/1-MCB-STA103-B25-000-3	272165	1.4 kg
	C	2 x 10 ⁴	8530/1-MCB-STA103-C25-000-3	272180	1.4 kg
32 A	B	10 ⁴	8530/1-MCB-STA103-B32-000-3	272166	1.4 kg
	C	10 ⁴	8530/1-MCB-STA103-C32-000-3	272181	1.4 kg
40 A	B	10 ⁴	8530/1-MCB-STA103-B40-000-3	272167	1.4 kg
	C	10 ⁴	8530/1-MCB-STA103-C40-000-3	272182	1.4 kg
50 A	B	10 ⁴	8530/1-MCB-STA103-B50-000-3	272168	1.4 kg
	C	10 ⁴	8530/1-MCB-STA103-C50-000-3	272183	1.4 kg
63 A	B	10 ⁴	8530/1-MCB-STA103-B63-000-3	272169	1.4 kg
	C	10 ⁴	8530/1-MCB-STA103-C63-000-3	267213	1.4 kg
Product variant		without auxiliary contacts			
No. of poles		3-pole + N			
1st auxiliary function		without			
2nd auxiliary function		without			
Rated operational voltage AC		230/400 V			
Rated operational current	Tripping characteristic	Electrical service life	Product Type	Art. No.	Weight
6 A	B	2 x 10 ⁴	8530/1-MCB-STA103N-B6-000-4	293843	1.8 kg
	C	2 x 10 ⁴	8530/1-MCB-STA103N-C6-000-4	293853	1.8 kg
10 A	B	2 x 10 ⁴	8530/1-MCB-STA103N-B10-000-4	293844	1.8 kg
	C	2 x 10 ⁴	8530/1-MCB-STA103N-C10-000-4	293854	1.8 kg
16 A	B	2 x 10 ⁴	8530/1-MCB-STA103N-B16-000-4	293846	1.8 kg
	C	2 x 10 ⁴	8530/1-MCB-STA103N-C16-000-4	293856	1.8 kg
20 A	B	2 x 10 ⁴	8530/1-MCB-STA103N-B20-000-4	293847	1.8 kg
	C	2 x 10 ⁴	8530/1-MCB-STA103N-C20-000-4	293857	1.8 kg
25 A	B	2 x 10 ⁴	8530/1-MCB-STA103N-B25-000-4	293848	1.8 kg
	C	2 x 10 ⁴	8530/1-MCB-STA103N-C25-000-4	293858	1.8 kg
32 A	B	10 ⁴	8530/1-MCB-STA103N-B32-000-4	293849	1.8 kg
	C	10 ⁴	8530/1-MCB-STA103N-C32-000-4	293859	1.8 kg
63 A	B	10 ⁴	8530/1-MCB-STA103N-B63-000-4	293852	1.8 kg
	C	10 ⁴	8530/1-MCB-STA103N-C63-000-4	293862	1.8 kg

For additional variants, e.g. auxiliary and signal contacts, please refer to the following type code.

Technical Data			
Variant	1st auxiliary function: Auxiliary contact 1 change-over contact 2nd auxiliary function: without	with auxiliary contacts 1st auxiliary function: Auxiliary contact 1 change-over contact + fault signal contact 1 change-over contact	without auxiliary contacts 1st auxiliary function: without
Explosion Protection			
Application range (Zone) note	For use in Zone 21/22 when protected by Ex tb/tc enclosure	For use in Zone 21/22 when protected by Ex tb/tc enclosure	For use in Zone 21/22 when protected by Ex tb/tc enclosure
IECEx gas explosion protection	Ex db eb IIC Gb	Ex db eb IIC Gb	Ex db eb IIC Gb
ATEX gas explosion protection	Ⓔ II 2 G Ex db eb IIC Gb	Ⓔ II 2 G Ex db eb IIC Gb	Ⓔ II 2 G Ex db eb IIC Gb
Certificates	ATEX (FM), Brazil (ULB), China (CQST), IECEx (FM)	ATEX (FM), Brazil (ULB), China (CQST), IECEx (FM)	ATEX (FM), Brazil (ULB), China (CQST), IECEx (FM)
Declaration of Conformity	Certificate of conformity (ATEX)	Certificate of conformity (ATEX), China (CCC)	Certificate of conformity (ATEX), China (CCC)
Electrical Data			
Frequency	50/60 Hz	50/60 Hz	50/60 Hz
Rated switching capacity	10 kA	10 kA	10 kA
Mechanical service life	2 x 10 ⁴	2 x 10 ⁴	2 x 10 ⁴
1st auxiliary function	Auxiliary contact 1 change-over contact	Auxiliary contact 1 change-over contact + fault signal contact 1 change-over contact	without
1st auxiliary function for AC rated voltage	230 V	230 V	-
1st auxiliary function for rated current max.	2 A	2 A	-
2nd auxiliary function	without	without	without
2nd auxiliary function voltage max. DC	-	-	-
Ambient Conditions			
Ambient temperature	-25 °C ... 55 °C	-25 °C ... 55 °C	-25 °C ... 55 °C
Ambient temperature	-13°F ... +131°F	-13°F ... +131°F	-13°F ... +131°F
Ambient temperature note	Deviating ambient temperatures based on current certificates available on request	Deviating ambient temperatures based on current certificates available on request	Deviating ambient temperatures based on current certificates available on request
Mechanical Data			
Degree of protection (IP) (IEC 60529)	IP2X	IP2X	IP2X
Enclosure material	Thermoplast	Thermoplast	Thermoplast
Connection cross section min.	1.5 mm ²	1.5 mm ²	1.5 mm ²
Connection cross-section max.	25 mm ²	25 mm ²	25 mm ²
Connection cross-section AWG min.	16 AWG	16 AWG	16 AWG
Connection cross-section AWG max.	4 AWG	4 AWG	4 AWG
Connection cross-section 2 min.	1.5 mm ²	1.5 mm ²	1.5 mm ²
Connection cross-section 2 max.	10 mm ²	10 mm ²	10 mm ²
Connection cross-section 2 AWG min.	16 AWG	16 AWG	16 AWG
Connection cross-section 2 AWG max.	8 AWG	8 AWG	8 AWG
Connection cross-section of auxiliary contact min.	0.5 mm ²	0.5 mm ²	
Connection cross-section of auxiliary contact max.	4 mm ²	4 mm ²	
Connection cross-section of auxiliary contact AWG min.	18	18	
Connection cross-section of auxiliary contact AWG max.	14	14	
Connection cross-section note	2-conductor connection (upper and lower chamber at the same time): - upper and lower chamber max. 16 / 10 mm ² (A maximum difference of one cross section may be clamped between the upper and lower chamber.) The permitted combinations of connection cross-sections can be found in the operating instructions.	2-conductor connection (upper and lower chamber at the same time): - upper and lower chamber max. 16 / 10 mm ² (A maximum difference of one cross section may be clamped between the upper and lower chamber.) The permitted combinations of connection cross-sections can be found in the operating instructions.	2-conductor connection (upper and lower chamber at the same time): - upper and lower chamber max. 16 / 10 mm ² (A maximum difference of one cross section may be clamped between the upper and lower chamber.) The permitted combinations of connection cross-sections can be found in the operating instructions.

Technical Data

Variant	1st auxiliary function: Auxiliary contact 1 change-over contact 2nd auxiliary function: without	with auxiliary contacts 1st auxiliary function: Auxiliary contact 1 change-over contact + fault signal contact 1 change-over contact	without auxiliary contacts 1st auxiliary function: without
Mounting / Installation			
Tightening torque	2 – 3 Nm	2 – 3 Nm	2 – 3 Nm
Tightening torque lbf in	17.7 to 26.6 lbf-in	17.7 to 26.6 lbf-in	17.7 to 26.6 lbf-in
Tightening torque auxiliary contact	0.4 – 0.6 Nm	0.4 – 0.6 Nm	0.4 – 0.6 Nm
Tightening torque auxiliary contact lbf in	3.5 to 5.3 lbf in	3.5 to 5.3 lbf in	3.5 to 5.3 lbf in

Technical Drawings – Subject to Alterations

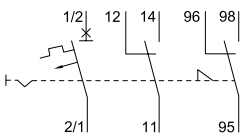

1-pole, auxiliary contact 1 change-over contact + fault signal contact 1 change-over contact

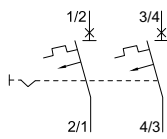

2-pole, without auxiliary contact

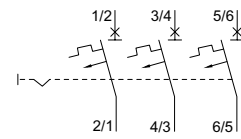

3-pole, without auxiliary contact

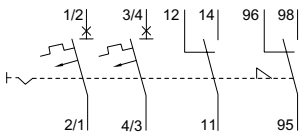

2-pole, auxiliary contact 1 change-over contact + fault signal contact 1 change-over contact

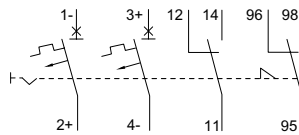

DC, 2-pole, auxiliary contact 1 change-over contact + fault signal contact 1 change-over contact

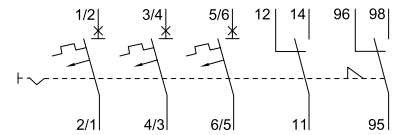

3-pole, auxiliary contact 1 change-over contact + fault signal contact 1 change-over contact

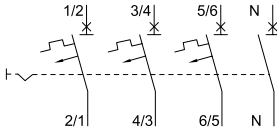

3-pole + N, without auxiliary contact

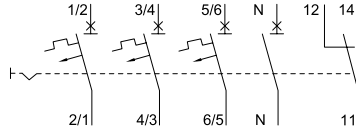

3-pole+N, auxiliary contact 1 change-over contact

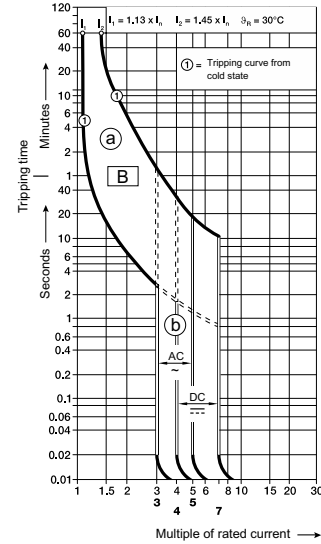

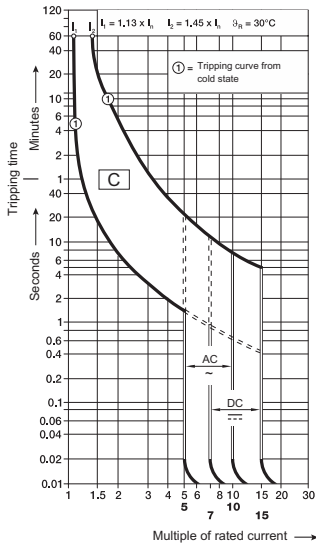

Tripping characteristic B

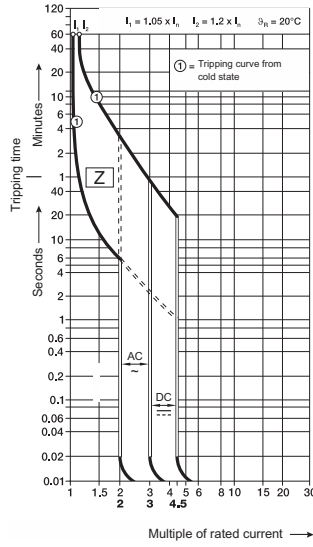

Tripping characteristic C



Tripping characteristic Z

Accessories			
Figure	Description	Art. No.	Weight
4-way locking device			
	A lock-out/tag-out hasp for individually locking the component using up to four cylinder locks.	227232	-
Cylinder lock			
	for closing (bracket $\varnothing 3$)	107115	15 g
Fastening set			
	A fastening set for fastening the component on the mounting plate without a DIN rail	276618	55 g

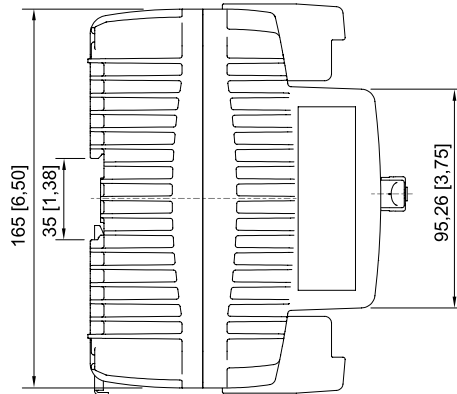
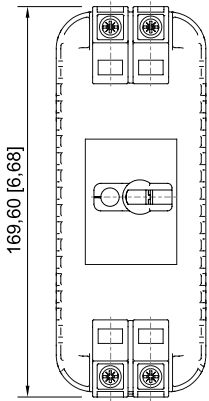
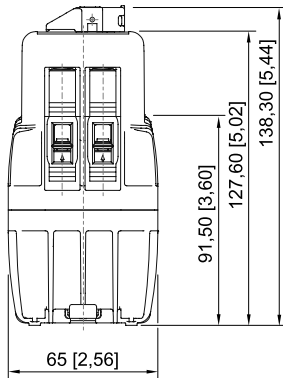

8530/1; 2 horizontal pitches

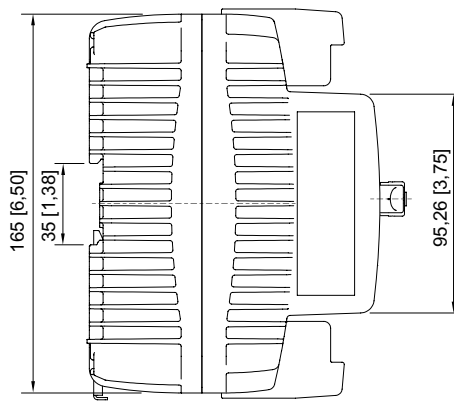
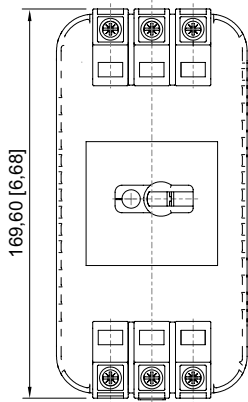
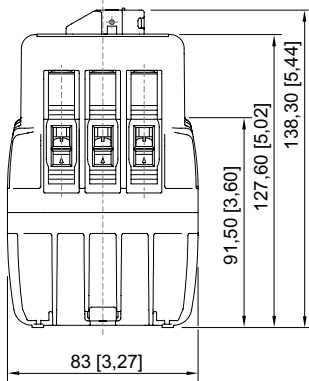

8530/1; 3 horizontal pitches

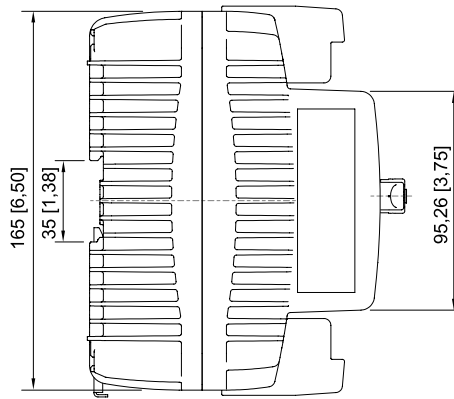
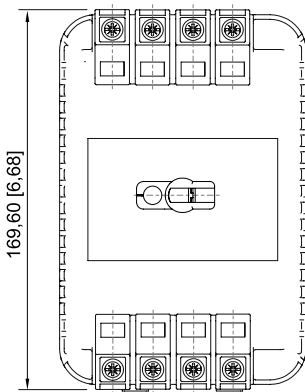
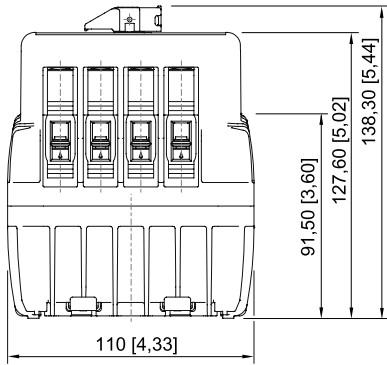

8530/1; 4 horizontal pitches

Type Code

09

8530 / 1 - MCB - ST A 10 1N - C 1,6 - 0 00 - 1

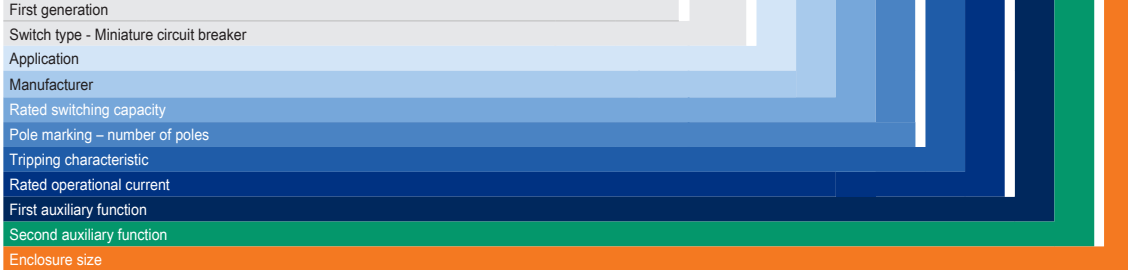

Code	Application
ST	IEC - AC
DC	IEC - DC
NA	North America - AC
ND	North America - DC

Code	Manufacturer
A	ABB
S	Siemens

Code	Rated switching capacity
10	10 kA

Code	Pole marking – number of poles
1	1-pole – single-pole MCB with one protected pole
1N	1-pole + N – two-pole MCB with one protected pole
2	2-pole – two-pole MCB with two protected poles
3	3-pole – three-pole MCB with three protected poles
3N	3-pole + N – four-pole MCB with three protected poles
4	4-pole – four-pole MCB with four protected poles

Code	Tripping characteristic
B	B characteristic
C	C characteristic
D	D characteristic
K	K characteristic
Z	Z characteristic

Code	Rated operational current
0,5	0,5 A
1	1 A
1,6	1,6 A
2	2 A
3	3 A
4	4 A
5	5 A
6	6 A
8	8 A
10	10 A
13	13 A
15	15 A
16	16 A
20	20 A
25	25 A
30	30 A
32	32 A
35	35 A
40	40 A
50	50 A
60	60 A
63	63 A

Code	First auxiliary function
0	without
1	1 W auxiliary contact
2	2 W auxiliary contact
3	1 W fault signal contact
4	1 W fault signal contact with reset button
5	1 W auxiliary contact + 1 W fault signal contact
6	1 W auxiliary contact + 1 W fault signal contact with reset button

Code	Second auxiliary function
00	without
10	12 V AC undervoltage release
11	12 V DC undervoltage release
12	24 V AC undervoltage release
13	24 V DC undervoltage release
14	48 V AC undervoltage release
15	48 V DC undervoltage release
16	110 V AC undervoltage release
17	110 V DC undervoltage release
18	230 V AC undervoltage release
19	230 V DC undervoltage release
20	400 V AC undervoltage release
40	12 to 60 V AC + 12 to 60 V DC shunt trip
41	24 to 60 V AC + 24 to 48 V DC shunt trip
42	24 to 48 V AC + 24 to 48 V DC shunt trip
43	110 to 415 V AC + 110 V DC shunt trip
44	110 to 415 V AC + 110 to 125 V DC shunt trip
45	110 to 415 V AC + 110 to 250 V DC shunt trip
46	110 to 480 V AC shunt trip
50	3 A 230 V AC relay coupler

Code	Enclosure size
1	1 horizontal pitch/1-pole (depending on the built-in components)
2	2 horizontal pitches/2-pole (depending on the built-in components)
3	3 horizontal pitches/3-pole (depending on the built-in components)
4	4 horizontal pitches/4-pole (depending on the built-in components)

Note:

- Please consult our technical sales department regarding the technical availability of configured variants.
- Please contact the Technical sales department for non-configurable variants.