



- Pushbutton, mushroom pushbutton, mushroom stay-put button with key lock, mushroom stay-put button, twin pushbutton and illuminated pushbutton, rotary actuator, key-operated switch, potentiometer bezel and indicator lamp bezel
- One axial actuator can actuate up to four Series 8082 contact elements
- Key-operated switches and rotary switches codable at any time as "latching/spring return" or "key not removable"

MY R. STAHL 8602A



Thanks to their special technical features, the actuators from the 8602/3 series can withstand the most extreme conditions. In addition to the application option for use in ambient temperatures from -60 °C to +70 °C, the IP degree of protection, IP66, is maintained in accordance with EN 60529. It is also possible to actuate up to four contact elements from the 8082 series with a single axial actuator from the 8602/3 series. The coding option of the key switches and rotary switches is innovative and one-of-a-kind. Integrated coding allows you to adjust the "latching/spring return" and/or "key not removable" functions at any time without additional accessories. A versatile set of accessories consisting of label holders and locking devices is available.

	IECEX / ATEX						
	Zone	0	1	2	20	21	22
Installation in		•	•		•	•	

	NEC® 500 CE Code Appendix J					
	Division	Class I		Class II		Class III
Installation in			•		•	

	CE Code Section 18					
	Zone	NEC® 505 Class I			NEC® 506	
Installation in			•	•		•

Selection Table						
Product Description Assembly Description note		Illuminated pushbutton Spring return 735 Pressure plate for 3 contact elements enclosed.				
Figure	Description	Silicone-free	Product Type	Art. No.	Weight	
	Ø 39 mm Black	Yes	8602C3-735-B-C06	244654	35 g	
	All colours	No	8602C3-735-S-C06	244655	35 g	
Product Description Assembly		Indicator lamp bezel 054				
Figure	Description	Silicone-free	Product Type	Art. No.	Weight	
	Ø 39 mm Black	Yes	8602C3-054-B-C06	223122	24 g	
	All colours	No	8602C3-054-S-C06	223123	24 g	



Selection Table



Product Description: Key-operated switch actuator  
 Assembly: 008  
 Description note: Conversion to the "spring return" or "key not removable" function is possible with the installed coding elements. Additional closures on request. Two keys enclosed. Pressure plates for 1-2 and 3-4 contact elements enclosed.

Figure	Description	Silicone-free	Product Type	Art. No.	Weight
	Ø 39 mm Black Closing: MS1 Number of switching positions: 2 Switching function: Latching / Latching	Yes	8602C3-008-B-M01-02-MS01	244573	50 g
	Ø 39 mm Black Closing: MS2 Number of switching positions: 2 Switching function: Latching / Latching	Yes	8602C3-008-B-M01-02-MS02	272935	60 g
	Ø 39 mm Black Closing: MS3 Number of switching positions: 2 Switching function: Latching / Latching	Yes	8602C3-008-B-M01-02-MS03	274089	50 g
	Ø 39 mm Black Closing: MS4 Number of switching positions: 2 Switching function: Latching / Latching	Yes	8602C3-008-B-M01-02-MS04	272936	60 g
	Ø 39 mm Black Closing: MS1 Number of switching positions: 2 Switching function: Latching / Latching	No	8602C3-008-S-M01-02-MS01	244574	50 g
	Ø 39 mm Black Closing: MS2 Number of switching positions: 2 Switching function: Latching / Latching	No	8602C3-008-S-M01-02-MS02	270418	50 g
	Ø 39 mm Black Closing: MS3 Number of switching positions: 2 Switching function: Latching / Latching	No	8602C3-008-S-M01-02-MS03	270419	50 g
	Ø 39 mm Black Closing: MS4 Number of switching positions: 2 Switching function: Latching / Latching	No	8602C3-008-S-M01-02-MS04	270420	50 g

Selection Table					
Product Description Assembly Description note		Key-operated switch actuator 008 Conversion to the "spring return" or "key not removable" function is possible with the installed coding elements. Additional closures on request. Two keys enclosed. Pressure plates for 1-2 and 3-4 contact elements enclosed.			
Figure	Description	Silicone-free	Product Type	Art. No.	Weight
	Ø 39 mm Black Closing: MS1 Number of switching positions: 3 Switching function: Latching / Latching / Latching	Yes	8602C3-008-B-M03-03-MS01	244632	50 g
	Ø 39 mm Black Closing: MS2 Number of switching positions: 3 Switching function: Latching / Latching / Latching	Yes	8602C3-008-B-M03-03-MS02	274090	50 g
	Ø 39 mm Black Closing: MS3 Number of switching positions: 3 Switching function: Latching / Latching / Latching	Yes	8602C3-008-B-M03-03-MS03	274091	50 g
	Ø 39 mm Black Closing: MS4 Number of switching positions: 3 Switching function: Latching / Latching / Latching	Yes	8602C3-008-B-M03-03-MS04	274092	50 g
	Ø 39 mm Black Closing: MS1 Number of switching positions: 3 Switching function: Latching / Latching / Latching	No	8602C3-008-S-M03-03-MS01	244633	50 g
	Ø 39 mm Black Closing: MS2 Number of switching positions: 3 Switching function: Latching / Latching / Latching	No	8602C3-008-S-M03-03-MS02	270421	50 g
	Ø 39 mm Black Closing: MS3 Number of switching positions: 3 Switching function: Latching / Latching / Latching	No	8602C3-008-S-M03-03-MS03	270422	50 g
	Ø 39 mm Black Closing: MS4 Number of switching positions: 3 Switching function: Latching / Latching / Latching	No	8602C3-008-S-M03-03-MS04	270423	50 g
Product Description Assembly Description note		Large rotary actuator Black - black 731 Lockable option (max. 3 times) can be determined using the enclosed closing parts. Lockable handle position: 45°. In the unmounted assemblies, the standard label is 0/OFF-I/ON and the long coupling part is enclosed. Other labels must be ordered separately.			
Figure	Description	Silicone-free	Product Type	Art. No.	Weight
	Ø 65 mm Handle colour: Black Protective collar colour: Black Designation plate: 0/OFF - I/ON Lockable in: 45° Not installed	Yes	8602C3-731-B-45X-E08	227225	40 g
		No	8602C3-731-S-45X-E08	227226	40 g

**Selection Table**

Product Description Assembly Description note		Large rotary actuator Black - black 731 Lockable option (max. 3 times) can be determined using the enclosed closing parts. Lockable handle position: 90°. In the unmounted assemblies, the standard label is 0/OFF-I/ON and the long coupling part is enclosed. Other labels must be ordered separately.			
Figure	Description	Silicone-free	Product Type	Art. No.	Weight
	Ø 65 mm Handle colour: Black Protective collar colour: Black Designation plate: 0/OFF – I/ON Lockable in: 90° Pre-installed	Yes	8602C3-731-B-90X-E02	251125	40 g
	Ø 65 mm Handle colour: Black Protective collar colour: Black Designation plate: 0/OFF – I/ON Lockable in: 90° Not installed	Yes	8602C3-731-B-90X-E08	227223	40 g
	Ø 65 mm Handle colour: Black Protective collar colour: Black Designation plate: 0/OFF – I/ON Lockable in: 90° Pre-installed	No	8602C3-731-S-90X-E02	251126	40 g
	Ø 65 mm Handle colour: Black Protective collar colour: Black Designation plate: 0/OFF – I/ON Lockable in: 90° Not installed	No	8602C3-731-S-90X-E08	227224	40 g
Product Description Assembly Description note		Large rotary actuator Increased height, BK-BK Black - black 728 Lockable option (max. 3 times) can be determined using the enclosed closing parts. Lockable handle position: 0°; safety switch. In the unmounted assemblies, the standard label is 0/OFF-I/ON and the long coupling part is enclosed. Other labels must be ordered separately.			
Figure	Description	Silicone-free	Product Type	Art. No.	Weight
	Ø 65 mm Handle colour: Black Protective collar colour: Black Designation plate: 0/OFF – I/ON Lockable in: 0° Pre-installed	No	8602C3-728-S-00X-E02	253174	40 g
Product Description Assembly Description note		Large rotary actuator Increased height, BK-BK Black - black 728 Lockable option (max. 3 times) can be determined using the enclosed closing parts. Lockable handle position: 45°. In the unmounted assemblies, the standard label is 0/OFF-I/ON and the long coupling part is enclosed. Other labels must be ordered separately.			
Figure	Description	Silicone-free	Product Type	Art. No.	Weight
	Ø 65 mm Handle colour: Black Protective collar colour: Black Designation plate: 0/OFF – I/ON Lockable in: 45° Not installed	Yes	8602C3-728-B-45X-E08	227213	40 g

Selection Table					
Product Description Assembly Description note		Large rotary actuator Increased height, BK-BK Black - black 728 Lockable option (max. 3 times) can be determined using the enclosed closing parts. Lockable handle position: 90°. In the unmounted assemblies, the standard label is 0/OFF-I/ON and the long coupling part is enclosed. Other labels must be ordered separately.			
Figure	Description	Silicone-free	Product Type	Art. No.	Weight
	Ø 65 mm Handle colour: Black Protective collar colour: Black Designation plate: 0/OFF – I/ON Lockable in: 90° Pre-installed	Yes	8602C3-728-B-90X-E02	227207	40 g
	Ø 65 mm Handle colour: Black Protective collar colour: Black Designation plate: 0/OFF – I/ON Lockable in: 90° Not installed	Yes	8602C3-728-B-90X-E08	227211	40 g
	Ø 65 mm Handle colour: Black Protective collar colour: Black Designation plate: 0/OFF – I/ON Lockable in: 90° Pre-installed	No	8602C3-728-S-90X-E02	227208	40 g
Product Description Assembly Description note		Large rotary actuator Increased height, red-yellow Red - yellow 729 Lockable option (max. 3 times) can be determined using the enclosed closing parts. Lockable handle position: 0°; safety switch. In the unmounted assemblies, the standard label is 0/OFF-I/ON and the long coupling part is enclosed. Other labels must be ordered separately.			
Figure	Description	Silicone-free	Product Type	Art. No.	Weight
	Ø 65 mm Handle colour: Red Protective collar colour: Yellow Designation plate: 0/OFF – I/ON Lockable in: 0° Pre-installed	No	8602C3-729-S-00X-E02	253175	40 g
Product Description Assembly Description note		Large rotary actuator Increased height, red-yellow Red - yellow 729 Lockable option (max. 3 times) can be determined using the enclosed closing parts. Lockable handle position: 45°. In the unmounted assemblies, the standard label is 0/OFF-I/ON and the long coupling part is enclosed. Other labels must be ordered separately.			
Figure	Description	Silicone-free	Product Type	Art. No.	Weight
	Ø 65 mm Handle colour: Red Protective collar colour: Yellow Designation plate: 0/OFF – I/ON Lockable in: 45° Not installed	Yes	8602C3-729-B-45X-E08	227217	40 g
	Ø 65 mm Handle colour: Red Protective collar colour: Yellow Designation plate: 0/OFF – I/ON Lockable in: 45° Not installed	No	8602C3-729-S-45X-E08	227218	40 g

### Selection Table

Product Description Assembly Description note	Large rotary actuator Increased height, red-yellow Red - yellow 729 Lockable option (max. 3 times) can be determined using the enclosed closing parts. Lockable handle position: 90°. In the unmounted assemblies, the standard label is 0/OFF-I/ON and the long coupling part is enclosed. Other labels must be ordered separately.				
---	---	--	--	--	--





Figure	Description	Silicone-free	Product Type	Art. No.	Weight
	Ø 65 mm Handle colour: Red Protective collar colour: Yellow Designation plate: 0/OFF – I/ON Lockable in: 90° Pre-installed	Yes	8602C3-729-B-90X-E02	227209	40 g
	Ø 65 mm Handle colour: Red Protective collar colour: Yellow Designation plate: 0/OFF – I/ON Lockable in: 90° Not installed	Yes	8602C3-729-B-90X-E08	227215	40 g
	Ø 65 mm Handle colour: Red Protective collar colour: Yellow Designation plate: 0/OFF – I/ON Lockable in: 90° Pre-installed	No	8602C3-729-S-90X-E02	227210	40 g
	Ø 65 mm Handle colour: Red Protective collar colour: Yellow Designation plate: 0/OFF – I/ON Lockable in: 90° Not installed	No	8602C3-729-S-90X-E08	227216	40 g

Product Description Assembly Description note	Large rotary actuator Maxi Black - black 736 Lockable option (max. 3 times) can be determined using the enclosed closing parts. Lockable handle position: Not defined. In the unmounted assemblies, the standard label is 0/OFF-I/ON; 0-EIN; AUS-AUTO-EIN; AUTO-0-BETRIEB-I and the long coupling part is enclosed. Other labels must be ordered separately.				
---	---	--	--	--	--

Figure	Description	Silicone-free	Product Type	Art. No.	Weight
	Ø 64 mm Handle colour: Black Protective collar colour: Black Designation plate: Multiple labels Lockable in: xx° not defined Pre-installed	Yes	8602C3-736-B-XXX-E99	276630	70 g
		No	8602C3-736-S-XXX-E99	270811	70 g

Product Description Assembly Description note	Large rotary actuator Maxi Red - yellow 737 Lockable option (max. 3 times) can be determined using the enclosed closing parts. Lockable handle position: Not defined. In the unmounted assemblies, the standard label is 0/OFF-I/ON; 0-EIN; AUS-AUTO-EIN; AUTO-0-BETRIEB-I and the long coupling part is enclosed. Other labels must be ordered separately.				
---	--	--	--	--	--

Figure	Description	Silicone-free	Product Type	Art. No.	Weight
	Ø 64 mm Handle colour: Red Protective collar colour: Yellow Designation plate: Multiple labels Lockable in: xx° not defined Pre-installed	Yes	8602C3-737-B-XXX-E99	276672	70 g
		No	8602C3-737-S-XXX-E99	276671	70 g

Selection Table					
Product Description Assembly		Large rotary actuator Red - yellow 730			
Description note		Lockable option (max. 3 times) can be determined using the enclosed closing parts. Lockable handle position: 45°. In the unmounted assemblies, the standard label is 0/OFF-I/ON and the long coupling part is enclosed. Other labels must be ordered separately.			
Figure	Description	Silicone-free	Product Type	Art. No.	Weight
	Ø 65 mm Handle colour: Red Protective collar colour: Yellow Designation plate: 0/OFF – I/ON Lockable in: 45° Not installed	Yes	8602C3-730-B-45X-E08	227221	40 g
Product Description Assembly		Large rotary actuator Red - yellow 730			
Description note		Lockable option (max. 3 times) can be determined using the enclosed closing parts. Lockable handle position: 90°. In the unmounted assemblies, the standard label is 0/OFF-I/ON and the long coupling part is enclosed. Other labels must be ordered separately.			
Figure	Description	Silicone-free	Product Type	Art. No.	Weight
	Ø 65 mm Handle colour: Red Protective collar colour: Yellow Designation plate: 0/OFF – I/ON Lockable in: 90° Pre-installed	Yes	8602C3-730-B-90X-E02	251123	40 g
	Ø 65 mm Handle colour: Red Protective collar colour: Yellow Designation plate: 0/OFF – I/ON Lockable in: 90° Not installed	Yes	8602C3-730-B-90X-E08	227219	40 g
	Ø 65 mm Handle colour: Red Protective collar colour: Yellow Designation plate: 0/OFF – I/ON Lockable in: 90° Pre-installed	No	8602C3-730-S-90X-E02	251124	40 g
	Ø 65 mm Handle colour: Red Protective collar colour: Yellow Designation plate: 0/OFF – I/ON Lockable in: 90° Not installed	No	8602C3-730-S-90X-E08	227220	40 g
Product Description Assembly		Mushroom pushbutton 55 mm Black 703			
Figure	Description	Silicone-free	Product Type	Art. No.	Weight
	Ø 55 mm Black Designation plate: Black, blank disc without text	Yes	8602C3-703-B	244642	55 g
		No	8602C3-703-S	244643	55 g
Product Description Assembly		Mushroom pushbutton 55 mm Red 014			
Figure	Description	Silicone-free	Product Type	Art. No.	Weight
	Ø 55 mm Black/red Designation plate: Red, blank disc without text	Yes	8602C3-014-B	244634	55 g
		No	8602C3-014-S	244635	55 g

Selection Table					
Product Description Assembly		Mushroom pushbutton Black 003			
Figure	Description	Silicone-free	Product Type	Art. No.	Weight
	Ø 39 mm Black	Yes	8602C3-003-B	244563	50 g
	Designation plate: Black, blank disc without text	No	8602C3-003-S	244564	50 g
Product Description Assembly		Mushroom pushbutton Red 004			
Figure	Description	Silicone-free	Product Type	Art. No.	Weight
	Ø 39 mm Red/black	Yes	8602C3-004-B	244565	50 g
	Designation plate: Red, blank disc without text	No	8602C3-004-S	244566	50 g
Product Description Assembly		Mushroom stay-put button 55 mm EM-STOP 015			
Figure	Description	Silicone-free	Product Type	Art. No.	Weight
	Ø 55 mm Yellow/red	Yes	8602C3-015-B	244636	55 g
	Designation plate: With yellow backing plate	No	8602C3-015-S	244637	55 g
Product Description Assembly		Mushroom stay-put button Black 012			
Figure	Description	Silicone-free	Product Type	Art. No.	Weight
	Ø 39 mm Black	Yes	8602C3-012-B	223699	50 g
		No	8602C3-012-S	223700	50 g
Product Description Assembly		Mushroom stay-put button EM-STOP 010			
Figure	Description	Silicone-free	Product Type	Art. No.	Weight
	Ø 39 mm Yellow/red	No	8602C3-010-S	223698	50 g
	Designation plate: With yellow backing plate	Yes	8602C3-010-B	223697	50 g



Selection Table					
Product Description Assembly Description note		Mushroom stay-put button With key 006 Two keys enclosed.			
Figure	Description	Silicone-free	Product Type	Art. No.	Weight
	Ø 39 mm Red/black Closing: MS1	Yes	8602C3-006-B .. MS1	223695	75 g
	Ø 39 mm Red/black Closing: MS2	Yes	8602C3-006-B .. MS2	270409	75 g
	Ø 39 mm Red/black Closing: MS3	Yes	8602C3-006-B .. MS3	270410	75 g
	Ø 39 mm Red/black Closing: MS4	Yes	8602C3-006-B .. MS4	270411	75 g
	Ø 39 mm Red/black Closing: MS1	No	8602C3-006-S .. MS1	223696	75 g
	Ø 39 mm Red/black Closing: MS2	No	8602C3-006-S .. MS2	270412	75 g
	Ø 39 mm Red/black Closing: MS3	No	8602C3-006-S .. MS3	270413	75 g
	Ø 39 mm Red/black Closing: MS4	No	8602C3-006-S .. MS4	270414	75 g

Selection Table					
Product Description Assembly		Mushroom stay-put button With key EM-STOP 009			
Description note		Two keys enclosed.			
Figure	Description	Silicone-free	Product Type	Art. No.	Weight
	Ø 39 mm Yellow/red Designation plate: With yellow backing plate Closing: MS1	Yes	8602C3-009-B .. MS1	223693	75 g
	Ø 39 mm Yellow/red Designation plate: With yellow backing plate Closing: MS2	Yes	8602C3-009-B .. MS2	274099	750 g
	Ø 39 mm Yellow/red Designation plate: With yellow backing plate Closing: MS3	Yes	8602C3-009-B .. MS3	274100	750 g
	Ø 39 mm Yellow/red Designation plate: With yellow backing plate Closing: MS4	Yes	8602C3-009-B .. MS4	274101	750 g
	Ø 39 mm Yellow/red Designation plate: With yellow backing plate Closing: MS1	No	8602C3-009-S .. MS1	223694	75 g
	Ø 39 mm Yellow/red Designation plate: With yellow backing plate Closing: MS2	No	8602C3-009-S .. MS2	270415	75 g
	Ø 39 mm Yellow/red Designation plate: With yellow backing plate Closing: MS3	No	8602C3-009-S .. MS3	270416	75 g
	Ø 39 mm Yellow/red Designation plate: With yellow backing plate Closing: MS4	No	8602C3-009-S .. MS4	270417	75 g
Product Description Assembly		Pushbutton 001			
Figure	Description	Silicone-free	Product Type	Art. No.	Weight
	Ø 39 mm Black	Yes	8602C3-001-B	223691	34 g
	Designation plate: Black, blank disc without text	No	8602C3-001-S	223692	34 g
Product Description Assembly		Rotary actuator (potentiometer) 092			
Description note		Labels provided separately.			
Figure	Description	Silicone-free	Product Type	Art. No.	Weight
	Ø 39 mm Black	Yes	8602C3-092-B-P04	244640	35 g
	Designation plate: 0 to 6, 0 to 10, and 0 to 100	No	8602C3-092-S-P04	244641	35 g

Selection Table					
Product Description Assembly Description note		Rotary actuator, small Not padlockable 726 Conversion to the "spring return" function is possible with the installed coding elements. Standard label enclosed separately. Different labels must be ordered in addition. Pressure plates for 1–2 and 3–4 contact elements enclosed.			
Figure	Description	Silicone-free	Product Type	Art. No.	Weight
	Ø 39 mm Black Designation plate: 0/OFF – I/ON Number of switching positions: 2 Lockable in: Not padlockable Switching function: Latching / Latching	Yes	8602C3-726-B-M01-02-E08	244646	40 g
	Ø 39 mm Black Designation plate: I – 0 – II Number of switching positions: 3 Lockable in: Not padlockable Switching function: Latching / Latching / Latching	Yes	8602C3-726-B-M03-03-E03	244648	40 g
Product Description Assembly Description note		Rotary actuator, small Not padlockable 726 With the installed coding elements, conversion to the "spring return" function is possible. Standard label enclosed separately. Different labels must be ordered separately. Pressure plates for 1-2 and 3-4 contact elements enclosed.			
Figure	Description	Silicone-free	Product Type	Art. No.	Weight
	Ø 39 mm Black Designation plate: 0/OFF – I/ON Number of switching positions: 2 Lockable in: Not padlockable Switching function: Latching / Latching	No	8602C3-726-S-M01-02-E08	244647	40 g
	Ø 39 mm Black Designation plate: I – 0 – II Number of switching positions: 3 Lockable in: Not padlockable Switching function: Latching / Latching / Latching	No	8602C3-726-S-M03-03-E03	244649	40 g
Product Description Assembly Description note		Rotary actuator, small Not padlockable 732 Label 0/OFF-I/ON enclosed separately. Different labels must be ordered separately.			
Figure	Description	Silicone-free	Product Type	Art. No.	Weight
	Ø 39 mm Black Designation plate: 0/OFF – I/ON Lockable in: Not padlockable	Yes	8602C3-732-B-90G-E08	264001	40 g
		No	8602C3-732-S-90G-E08	264002	40 g
Product Description Assembly Description note		Rotary actuator, small Padlockable 727 Conversion to the "spring return" function is possible with the installed coding elements. Standard label enclosed separately. Different labels must be ordered in addition. Cylinder lock not enclosed. Pressure plates for 1–2 and 3–4 contact elements enclosed.			
Figure	Description	Silicone-free	Product Type	Art. No.	Weight
	Ø 39 mm Black Designation plate: 0/OFF – I/ON Number of switching positions: 2 Lockable in: One pos. with one lock Switching function: Latching / Latching	Yes	8602C3-727-B-M01-02-E08	244650	40 g
		No	8602C3-727-S-M01-02-E08	244651	40 g

**Selection Table**

Product Description Assembly Description note		Rotary actuator, small Padlockable 727 Conversion to the "spring return" function is possible with the installed coding elements. Standard label enclosed separately. Different labels must be ordered in addition. Cylinder lock not enclosed. Pressure plates for 1–2 and 3–4 contact elements enclosed.			
Figure	Description	Silicone-free	Product Type	Art. No.	Weight
	Ø 39 mm Black	Yes	8602C3-727-B-M03-03-E03	244652	40 g
	Designation plate: I – 0 – II Number of switching positions: 3 Lockable in: One pos. with one lock Switching function: Latching / Latching / Latching	No	8602C3-727-S-M03-03-E03	244653	40 g
Product Description Assembly Description note		Rotary actuator, small Padlockable 734 0/OFF-I/ON label provided separately. Cylinder lock not enclosed. Other labels must be ordered separately.			
Figure	Description	Silicone-free	Product Type	Art. No.	Weight
	Ø 39 mm Black	Yes	8602C3-734-B-45H-E08	227391	40 g
	Designation plate: 0/OFF – I/ON Lockable in: One pos. with one lock	No	8602C3-734-S-45H-E08	227392	40 g
	Ø 39 mm Black	Yes	8602C3-734-B-90H-E08	227359	40 g
	Designation plate: 0/OFF – I/ON Lockable in: One pos. with one lock	No	8602C3-734-S-90H-E08	227360	40 g
Product Description Assembly Description note		Twin pushbutton 023 Select other labels from the accessories.			
Figure	Description	Silicone-free	Product Type	Art. No.	Weight
	Black	Yes	8602C3-023-B	244638	45 g
		No	8602C3-023-S	244639	45 g

**Technical Data**

Variant	Actuators with standard seal	Actuators with silicone seal
<b>Explosion Protection</b>		
IECEX gas explosion protection	Ex eb IIC Gb	Ex eb IIC Gb
IECEX dust explosion protection	Ex tb IIIC Db	Ex tb IIIC Db
ATEX gas explosion protection	Ⓜ II 2 G Ex eb IIC Gb	Ⓜ II 2 G Ex eb IIC Gb
ATEX dust explosion protection	Ⓜ II 2 D Ex tb IIIC Db	Ⓜ II 2 D Ex tb IIIC Db
Certificates	ATEX (PTB), Brazil (ULB), Canada / USA (UL), Canada (UL), IECEx (PTB), India (PESO), Korea (KGS)	ATEX (PTB), Brazil (ULB), Canada / USA (UL), Canada (UL), IECEx (PTB), India (PESO), Korea (KGS)
<b>Ambient Conditions</b>		
Ambient temperature	-20 °C ... +60 °C	-60 °C ... +70 °C
Ambient temperature	-4 °F ... +140 °F	-76 °F ... +158 °F
Storage temperature	-13 °F ... +140 °F	-76 °F ... +158 °F
Storage temperature	-25 °C ... +60 °C	-60 °C ... +70 °C
Degree of contamination	3	3
Notes	Actuators with silicone seals have coloured labels on the bottom.	
<b>Mechanical Data</b>		
Degree of protection (IP)	IP66	IP66
Note on degree of protection	According to IEC/EN 60529	According to IEC/EN 60529
Enclosure material	Polyamide	Polyamide

Technical Data		
Variant	Actuators with standard seal	Actuators with silicone seal
Mechanical Data		
Service life, min.	10 <sup>6</sup> actuations	10 <sup>6</sup> actuations
Mounting / Installation		
Tightening torque	3 Nm	3 Nm

Technical Drawings – Subject to Alterations

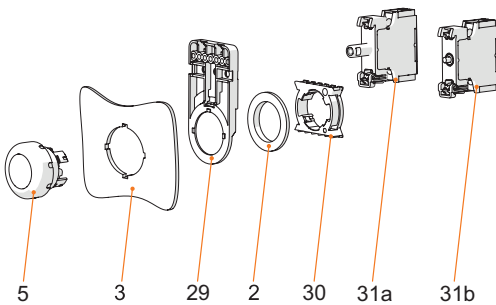

Front installation mounting with Series 8010/6 indicator lamp and Series 8082/3 contact element

**Key**  
 2 = jam nut (order no. 205592)    3 = installation wall (wall thickness max. 5 mm [0.197 inch])  
 29 = support for cable duct (optional) (order no. 248673)  
 30 = adaptor (order no. 227038)    31a = built-in element: LED element 8010/6    31b = built-in element: Contact element 8082/3

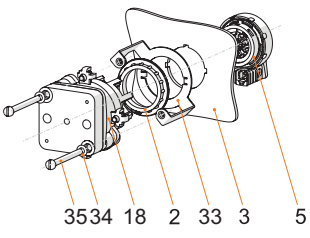

Front installation mounting with Series 8008 control switch

**Key**  
 2 = jam nut (order no. 205592)  
 3 = installation wall (wall thickness max. 2 mm [0.0787 inch])  
 5 = 8302/3 actuator with seal (4)  
 18 = 8008/2- control switch  
 33 = front installation 8602/3 adaptor for type 8008/2  
 34 = M4 disc  
 35 = M4x screw

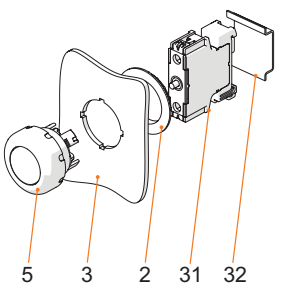

Mounting rail mounting

**Key**  
 2 = jam nut (order no. 205592)    3 = installation wall (wall thickness max. 5 mm [0.197 inch])  
 5 = actuator with seal  
 31 = built-in element    32 = TS35 mounting rail

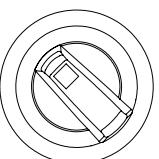

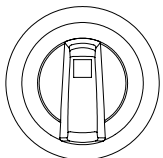

**Explanation of position display:**  
 Standard switch, lockable in 0/OFF  
 Position of handle 45°



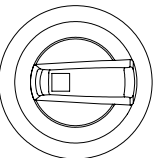











**Explanation of position display:**  
 Safety switch, lockable in I/ON  
 Position of handle 0°



**Explanation of position display:**  
 Standard switch, lockable in 0/OFF  
 Position of handle 90°











Accessories				
Figure	Description	Art. No.	Weight	
Spare key				
	Closing MS1	107109	8 g	
	Closing MS2	272645	8 g	
	Closing MS3	272646	8 g	
	Closing MS4	272647	8 g	
Cylinder lock				
	for closing (bracket Ø 3)	107115	15 g	

Spare Parts				
Figure	Description	Art. No.	Weight	
Locking devices				
	8602C3-752 for actuated mushroom stay-put button BG010, BG012	244869	90 g	
	8602C3-753 for not actuated pushbutton BG001	244870	90 g	
	8602C3-754 for actuated pushbutton BG001	244871	90 g	
	8602C3-755 for not actuated pushbutton BG001	244872	90 g	
	8602C3-756 for actuated mushroom stay-put button BG010, BG012	244873	90 g	
	8602C3-758 for not actuated mushroom stay-put button BG010, BG012	244874	90 g	
Insert discs for label holder				
	One-line Plain Material: PVC Colour: White Self-adhesive	238271	10 g	
	Two-line Plain Material: PVC Colour: White Self-adhesive	238272	10 g	
	Three-line Plain Material: PVC Colour: White Self-adhesive	238273	10 g	

Spare Parts			
Figure	Description	Art. No.	Weight
Label, yellow, general			
	for Ø 39 actuator (EM-STOP)	223571	1 g
	for Ø 55 actuator (EM-STOP)	223572	1 g
	for special, Ø 55 actuator (EM-STOP), e.g. series 8040	223573	1 g
Labels for small BG 732, BG 734 rotary actuator			
	Dia. 30.8 0/OFF I/ON	227489	2 g
	Dia. 30.8 0 I	227490	2 g
	Dia. 30.8 I 0 II	227491	2 g
	Dia. 30.8 0 I	227492	2 g
	Dia. 30.8 MANUAL 0 AUTO	227494	2 g
	Dia. 30.8 OFF ON	269983	2 g
	Dia. 30.8 AUTO 0 MANUAL ON	269984	2 g
	Dia. 30.8 AUTO 0 MANUAL	269985	2 g









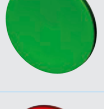

Spare Parts				
Figure	Description	Art. No.	Weight	
Labels for small BG 732, BG 734 rotary actuator and BG 726, BG 727 axial rotary actuator				
	Dia. 30.8 Plain	227495	2 g	
Labels for axial BG 726, BG 727 rotary actuator				
	Dia. 30.8 0/OFF I/ON	240472	2 g	
	Dia. 30.8 I 0 II	240474	2 g	
	Dia. 30.8 0 I	240475	2 g	
	Dia. 30.8 MANUAL 0 AUTO	240477	2 g	
Labels for BG 092 rotary actuator				
	Dia. 30.8 0 to 6	227496	2 g	
	Dia. 30.8 0 to 10	227497	2 g	
	Dia. 30.8 0 to 100	227498	2 g	
Labels for large BG 728, BG 729, BG 730, BG 731 rotary actuator				
	Dia. 58 0/OFF I/ON	227004	2 g	
	Dia. 58 0 OPERATION I	227005	2 g	
	Dia. 58 0 I II	227006	2 g	



Spare Parts			
Figure	Description	Art. No.	Weight
Labels for large BG 728, BG 729, BG 730, BG 731 rotary actuator			
	Dia. 58 I O II	227007	2 g
	Dia. 58 I II	227008	2 g
	Dia. 58 0 I	227009	2 g
	Dia. 58 I O I O	227010	2 g
	Dia. 58 MANUAL 0 AUTO	227011	2 g
	Dia. 58 0/OFF I/ON	227012	2 g
	Dia. 58, yellow 0/OFF I/ON	227013	2 g
	Dia. 58 0 I (90°)	273760	2 g
	Dia. 58 Plain	227014	2 g
Labels for BG 736, BG 737 rotary actuator			
	Dia. 58.5 0/OFF I/ON	274882	2 g
	Dia. 58.5 0 OPERATION I	263982	2 g





Spare Parts				
Figure	Description	Art. No.	Weight	
Labels for BG 736, BG 737 rotary actuator				
	Dia. 58.5 0 ON	270806	2 g	
	Dia. 58.5 OFF AUTO ON	270807	2 g	
	Dia. 58.5 AUTO 0 OPERATION I	270808	2 g	
Designation plate for pushbutton and selector switch				
	Black Text: O	227741	1 g	
	Black Text: I	227747	1 g	
	Black Text: II	227754	1 g	
	Black Symbol: Straight arrow, 45°	227778	1 g	
	Black Text: ON	227808	1 g	
	Black Text: OFF	227811	1 g	
	Blue Text: RESET	227926	1 g	
	Green Text: I	227750	1 g	

Spare Parts			
Figure	Description	Art. No.	Weight
Designation plate for pushbutton and selector switch			
	Green Text: II	227753	1 g
Designation plates for pushbutton and selector switch			
	Green Text: START	227801	1 g
Designation plate for pushbutton and selector switch			
	Red Text: STOP	227804	1 g
	Red Text: OFF	227810	1 g
		227814	1 g
	Red Text: O	227740	1 g
	White Text: I	227751	1 g
	Black Blank disc without text	215425	1 g
	Blue Blank disc without text	215427	1 g
	Green Blank disc without text	215424	1 g
	Red Blank disc without text	215423	1 g

Spare Parts			
Figure	Description	Art. No.	Weight
<b>Designation plate for pushbutton and selector switch</b>			
	Red Symbol: Right arrow	272628	1 g
	White Blank disc without text	215426	1 g
	Yellow Blank disc without text	215428	1 g
<b>Closing part</b>			
	8602C3-733-B for closing unused holes in cover, dia. 30.5 mm, NBR	244306	25 g
	8602C3-733-S for closing unused holes in cover, dia. 30.5 mm, silicone	244307	25 g
<b>Colour filter for BG 735</b>			
	for illuminated pushbutton, all colours packaged	248684	1 g
<b>Caps for BG054</b>			
	for indicator lamp, all colours packaged	248685	3 g
<b>Designation plates set for ASSY001, ASSY023</b>			
	The button label set contains eight labels 5x blank disc without text in red, green, white, blue and yellow 1x red label, text: STOP 1x green label, text: START 1x blue label, text: RESET	321791	-
<b>Label set for ASSY732</b>			
	The label set contains two dia. 30.8 mm labels 1x label with text HAND-0-AUTO 1x label with text LOCAL-REMOTE	321792	-
<b>Protective collar</b>			
	8602C3-751 plastic/red for mushroom stay-put button with key lock/mushroom stay-put button dia. 39 BG006, BG009, BG010, BG012	257707	20 g
	8602C3-751 plastic/yellow for mushroom stay-put button with key lock/mushroom stay-put button dia. 39 BG006, BG009, BG010, BG012	257708	20 g

Spare Parts			
Figure	Description	Art. No.	Weight
<b>Label holder</b>			
	Size 1, without insert disc, 1-line label for actuators Ø 39	223566	2 g
	Size 2, without insert disc, 1- or 2-line label for actuators Ø 39	223567	2 g
	Size 3, without insert disc, 1-, 2- or 3-line label for actuators Ø 39	223568	2 g
<b>Special key</b>			
	for tightening plastic locking nut	169101	30 g
<b>Pressure plates</b>			
	Dia. 37 mm Three contact elements	215436	2 g
	Dia. 48.5 mm Four contact elements	215437	2 g
	For twin pushbutton Four contact elements	221706	1 g
	For key-operated switch and axial rotary actuator 1 to 2 contact elements	253627	1 g
	For key-operated switch and axial rotary actuator 3 to 4 contact elements	221707	1 g
<b>Covering</b>			
	for NEC indicator lamp BG 054 and NEC potentiometer BG 092	252023	38 g
	for NEC front installation indicating lamp BG 054	253260	30 g

### Spare Parts

Figure	Description	Art. No.	Weight
<b>Holder for front installation</b>			
	8602/3 holder for cable duct	248673	50 g
<b>Adaptor for front installation</b>			
	8602/3 Front installation for indicator lamp series 8010/6 and contact element series 8082/3	227038	8 g
	8602/3 front installation for control switch of Series 8008	260081	-
<b>LED indicator lamp for front installation</b>			
	for Ex e front installation	240900	30 g
	for Ex i front installation	240901	30 g
	for SA front installation	274899	34 g
<b>8082/3 Contact element</b>			
	For NC front installation	240898	25 g
	for NO contact front installation	240899	25 g

### Dimensional Drawings (All Dimensions in mm [inches]) – Subject to Alterations

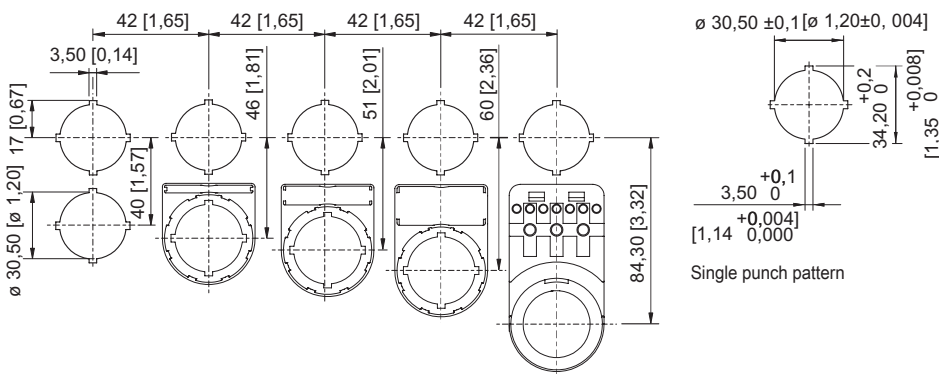

### Cut-out with/without additional designation plate

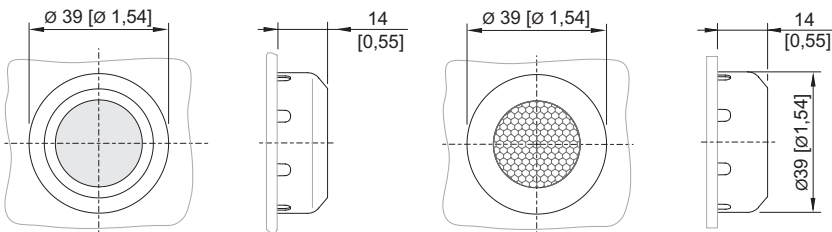

8602/3-001 pushbutton  
Actuator with axial actuation

8602/3-735 illuminated pushbutton  
Actuator with axial actuation

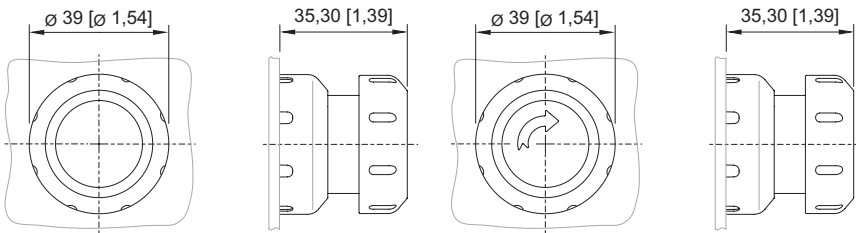

8602/3-003 black mushroom pushbutton  
8602/3-004 red/black mushroom pushbutton  
Actuator with axial actuation

8602/3-010 red/yellow mushroom stay-put button  
8602/3-012 black/black mushroom stay-put button  
Actuator with axial actuation

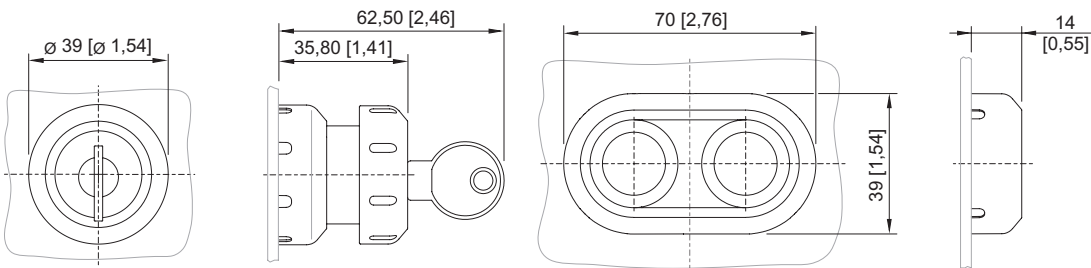

8602/3-006 red/black mushroom stay-put button with key lock  
8602/3-009 red/yellow mushroom stay-put button with key lock  
Actuator with axial actuation

8602/3-023 twin pushbutton  
Actuator with axial actuation

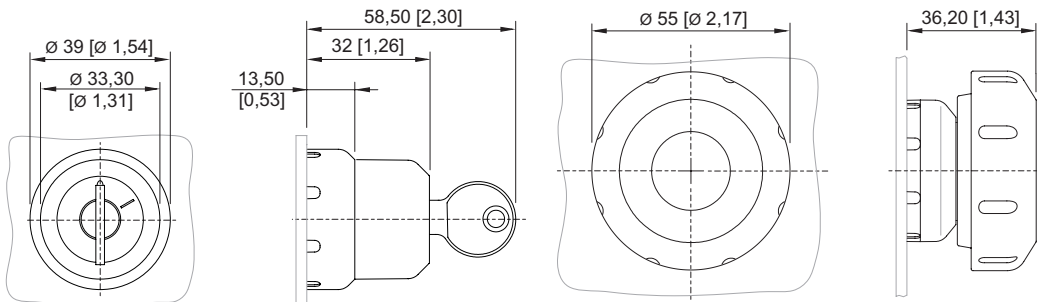

8602/3-008 MS key-operated switch  
Actuator with axial actuation

8602/3-014 red/black mushroom pushbutton  
8602/3-703 black/black mushroom pushbutton  
Actuator with axial actuation

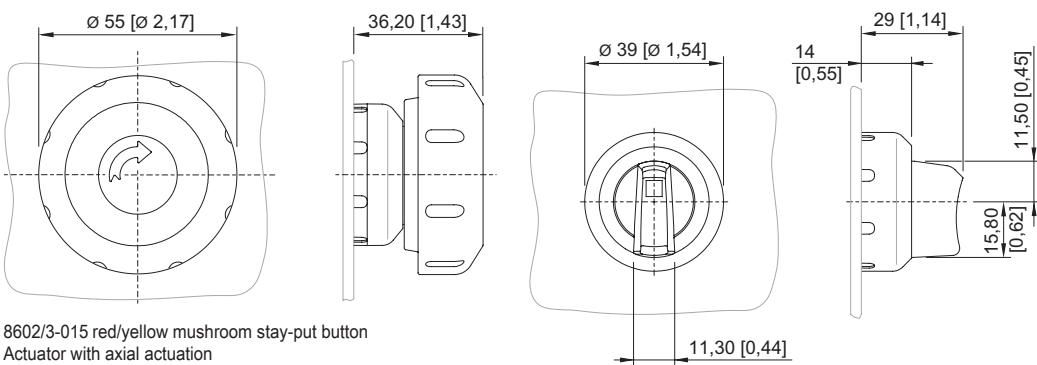

8602/3-015 red/yellow mushroom stay-put button  
Actuator with axial actuation

8602/3-726 axial rotary actuator, not lockable  
Actuator with axial actuation

E4

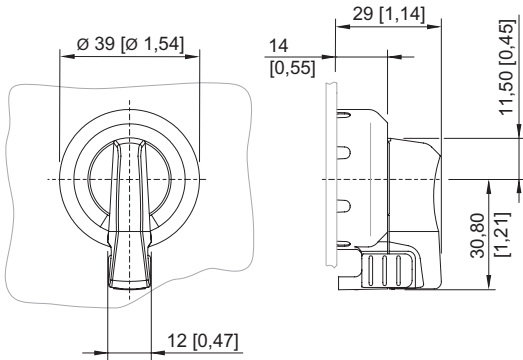

8602/3-727 axial rotary actuator, lockable  
Actuator with axial actuation

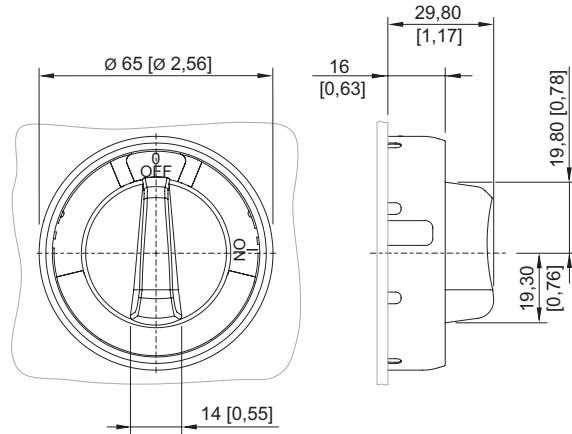

8602/3-728 rotary actuator, black handle, red protective collar  
8602/3-729 rotary actuator, red handle, black protective collar  
Actuator with radial actuation

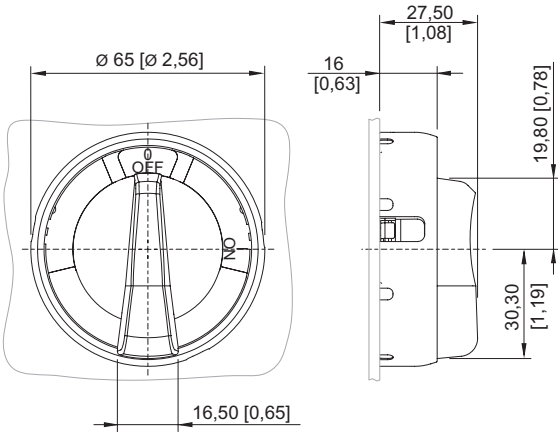

8602/3-730 rotary actuator, red handle, yellow protective collar  
8602/3-731 rotary actuator, black handle, black protective collar  
Actuator with radial actuation

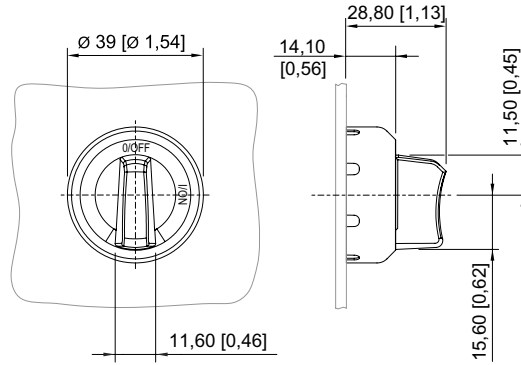

8602/3-732 rotary actuator, not lockable  
Actuator with radial actuation

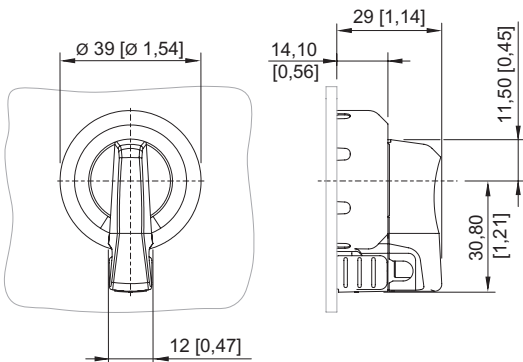

8602/3-734 rotary actuator, lockable using one lock  
Actuator with radial actuation

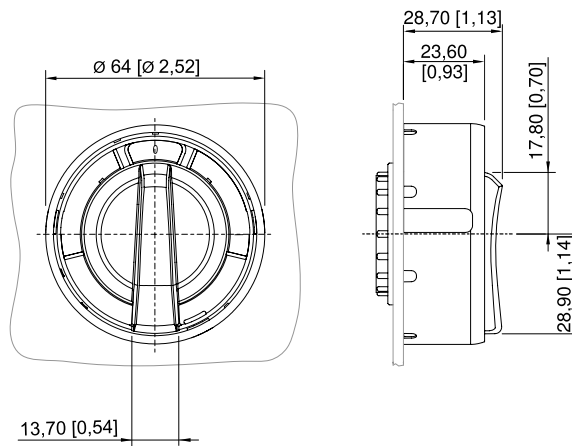

8602/3-736 maxi rotary actuator, black handle, black protective collar  
8602/3-737 maxi rotary actuator, red handle, yellow protective collar  
Actuator with radial actuation



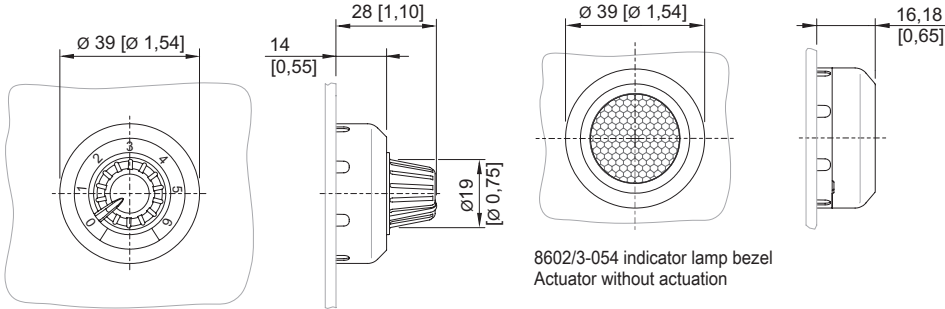

8602/3-092 potentiometer bezel  
Actuator with radial actuation

8602/3-054 indicator lamp bezel  
Actuator without actuation

Use of actuators

			Potential built-in elements mounting rail mounting							Potential built-in elements front installation	
			8082			8010	8208/24	8008	8006	8082/8010 adaptor 227038	8008 with adaptor 260081
			1/2 elements	3 elements	4 elements					max. 3 elements	
BG: 8602C3-xxx	Actuator	Direction of actuation	Standard	Pressure plate SAP no.							
001	Pushbutton	axial	x	215436	215437	--	x	--	--	x	--
003	Mushroom pushbutton black	axial	x	215436	215437	--	x	--	--	x	--
004	Mushroom pushbutton red	axial	x	215436	215437	--	x	--	--	x	--
006	Mushroom stay-put button with key lock	axial	x	215436	215437	--	x	--	--	x	--
008	Key-operated button	axial	2 x 253627 <sup>1)</sup>	--	2 x 221707 <sup>1)</sup>	--	--	--	--	2 x 253627 1 left/ 1 right	--
009	Mushroom stay-put button with key lock EM-STOP	axial	x	215436	215437	--	x	--	--	x	--
010	Mushroom stay-put button EM-STOP	axial	x	215436	215437	--	x	--	--	x	--
012	Mushroom stay-put button black	axial	x	215436	215437	--	x	--	--	x	--
014	Mushroom pushbutton red, Ø 55	axial	x	215436	215437	--	x	--	--	x	--
015	Mushroom stay-put button EM-STOP, Ø 55	axial	x	215436	215437	--	x	--	--	x	--
023	Twin pushbutton	axial	x	--	2 x 221706	--	--	--	--	1 left/ 1 right	--
054	Indicator lamp bezel	--	--	--	--	x	--	--	--	--	--
092	Potentiometer actuator	radial	--	--	--	--	x	--	--	--	--
703	Mushroom pushbutton black, Ø 55	axial	x	215436	215437	--	x	--	--	x	--
726	Axial rotary actuator, not lockable	axial	2 x 253627 <sup>1)</sup>	--	2 x 221707 <sup>1)</sup>	--	--	--	--	2 x 253627 1 left/ 1 right	--
727	Axial rotary actuator, lockable	axial	2 x 253627 <sup>1)</sup>	--	2 x 221707 <sup>1)</sup>	--	--	--	--	2 x 253627 1 left/ 1 right	--
728	Large rotary actuator, increased height, bk-bk	radial	--	--	--	--	--	x	x	--	x
729	Large rotary actuator, increased height, rd-ye	radial	--	--	--	--	--	x	x	--	x
730	Large rotary actuator, rd-ye	radial	--	--	--	--	--	x	x	--	x
731	Large rotary actuator, bk-bk	radial	--	--	--	--	--	x	x	--	x
732	Small rotary actuator, bk-bk	radial	--	--	--	--	--	x	--	--	x
734	Small rotary actuator, lockable	radial	--	--	--	--	--	x	--	--	x
735	Illuminated pushbutton	axial	x	215436 <sup>1)</sup>	--	x	--	--	--	x	--
736	Rotary actuator maxi, bk-bk	radial	--	--	--	--	--	x	x	--	x
737	Rotary actuator maxi, rd-ye	radial	--	--	--	--	--	x	x	--	x

<sup>1)</sup>enclosed in the packed assembly

Functions

E4

Pushbutton actuator	Spring return function; replaceable designation labels
Mushroom pushbutton actuator	Spring return function; replaceable designation labels
Mushroom stay-put button actuator	Press to lock, turn right to unlock; yellow backing plate enclosed; for use for EM-STOP function
Mushroom stay-put button actuator with key lock	Press to lock; unlock only with key; yellow backing plate enclosed; for use for EM-STOP function
Key-operated button actuator	Switching function with 2 or 3 latching positions; key removable in all positions; "spring return" and/or "key not removable" functions are codeable
Twin pushbutton actuator	Spring return function; 2 push buttons in one actuator; replaceable designation labels
Rotary actuator, axial	Switching function with 2 or 3 latching positions
Closing part	For closing unused holes in cover
Small rotary actuator	Switching function
Large rotary actuator	Switching function
Potentiometer	Infinitely variable
Illuminated pushbutton	Spring return / illumination function; replaceable colour filters
Indicator lamp	Illumination function; replaceable coloured caps