



- Large temperature range of use
- Large inner connection chamber
- Plastic Ex e enclosure
- Degree of protection IP66/67
- Five different contact versions
- Different actuator versions which can be repositioned by 4 x 90°
- Can also be used as simple apparatus

E4

MY R. STAHL 8070C



Position switches are used to position, control and monitor the moving parts on machines and systems. Because they meet the requirements of the EN 50 041 and IEC 60947-5-1 product standards, they can also be used as a position switch with a safety function. Series 8070/2 position switches are approved for use in hazardous areas of Zones 1, 2, 21 and 22.

In conjunction with a safety door guard and the corresponding circuitry, the PL position switches fulfil the requirements of “e” in accordance with EN ISO 13849-1, or up to SIL 3 in accordance with EN 62061. They are identified with the ⊕ character to signify positive opening. There are snap- and slow-action versions with different types of contacts as well as with a variety of different actuating elements.

	IECEX / ATEX					
Zone	0	1	2	20	21	22
Installation in		•	•		•	•

Selection Table						
Actuator		Adjustable rotary lever				
Figure	Contacts	Switching function	Positive opening operation	Product Type	Art. No.	Weight
	1 NC + 1 NO	Slow-action contact	No	8070/2-1-DS-U60	275363	256 g
		Slow-action contact, Overlapping	No	8070/2-5-DS-U60	275367	167 g
		Snap-action contact	No	8070/2-2-DS-U60	275364	256 g
	2 NC	Slow-action contact	No	8070/2-3-DS-U60	275365	256 g
2 NO	Slow-action contact	No	8070/2-3-DS-U60	275366	167 g	
Actuator		Parallel roller lever				
Figure	Contacts	Switching function	Positive opening operation	Product Type	Art. No.	Weight
	1 NC + 1 NO	Slow-action contact	Yes	8070/2-1-WPH-U60	258222	170 g
		Snap-action contact	Yes	8070/2-2-WPH-U60	258230	170 g
		Snap-action contact	No	8070/2-5-WPH-U60	268114	167 g
	2 NC	Slow-action contact	Yes	8070/2-3-WPH-U60	268111	167 g

Selection Table						
Actuator		Plunger				
Figure	Contacts	Switching function	Positive opening operation	Product Type	Art. No.	Weight
	1 NC + 1 NO	Slow-action contact	Yes	8070/2-1-W-U60	258219	167 g
		Slow-action contact, Overlapping	Yes	8070/2-5-W-U60	258243	167 g
		Snap-action contact	Yes	8070/2-2-W-U60	258227	167 g
	2 NC	Slow-action contact	Yes	8070/2-3-W-U60	258235	167 g
	2 NO	Slow-action contact	No	8070/2-4-W-U60	268432	167 g
Actuator		Rod lever				
Figure	Contacts	Switching function	Positive opening operation	Product Type	Art. No.	Weight
	1 NC + 1 NO	Slow-action contact	No	8070/2-1-DD-U60	275068	242 g
		Slow-action contact, Overlapping	No	8070/2-5-DD-U60	275362	242 g
		Snap-action contact	No	8070/2-2-DD-U60	258233	242 g
		Snap-action contact	No	8070/2-2-DD-U60	275069	242 g
	2 NC	Slow-action contact	No	8070/2-3-DD-U60	275070	242 g
	2 NO	Slow-action contact	No	8070/2-4-DD-U60	275361	167 g
Actuator		Roller lever				
Figure	Contacts	Switching function	Positive opening operation	Product Type	Art. No.	Weight
	1 NC + 1 NO	Slow-action contact	Yes	8070/2-1-WH-U60	258221	168 g
		Snap-action contact	Yes	8070/2-2-WH-U60	258229	168 g
		Snap-action contact	No	8070/2-5-WH-U60	268113	167 g
	2 NC	Slow-action contact	Yes	8070/2-3-WH-U60	258237	168 g
	2 NO	Snap-action contact	No	8070/2-4-WH-U60	268434	167 g
Actuator		Roller plunger				
Figure	Contacts	Switching function	Positive opening operation	Product Type	Art. No.	Weight
	1 NC + 1 NO	Slow-action contact	Yes	8070/2-1-R-U60	258220	168 g
		Snap-action contact	Yes	8070/2-2-R-U60	258228	168 g
		Snap-action contact	No	8070/2-5-R-U60	268112	167 g
	2 NC	Slow-action contact	Yes	8070/2-3-R-U60	258236	168 g
	2 NO	Snap-action contact	No	8070/2-4-R-U60	268433	167 g
Actuator		Rotary lever				
Figure	Contacts	Switching function	Positive opening operation	Product Type	Art. No.	Weight
	1 NC + 1 NO	Slow-action contact	Yes	8070/2-1-D-U60	275063	234 g
		Slow-action contact, Overlapping	Yes	8070/2-5-D-U60	275067	167 g
		Snap-action contact	Yes	8070/2-2-D-U60	275064	234 g
	2 NC	Slow-action contact	Yes	8070/2-3-D-U60	275065	234 g
	2 NO	Slow-action contact	No	8070/2-4-D-U60	275066	243 g
Actuator		Safety switch				
Figure	Contacts	Switching function	Positive opening operation	Product Type	Art. No.	Weight
	1 NC + 1 NO	Slow-action contact	Yes	8070/2-1-AZ-U60	258226	194 g
	2 NC	Slow-action contact	Yes	8070/2-3-AZ-U60	258241	194 g

Selection Table						
Actuator		Spring rod head				
Figure	Contacts	Switching function	Positive opening operation	Product Type	Art. No.	Weight
	1 NC + 1 NO	Snap-action contact	No	8070/2-2-TK300-U60	275346	204 g
		Snap-action contact	No	8070/2-2-TK-U60	258234	204 g

The actuators are included, but not installed.
 Actuators without positive opening are not suitable for safety circuits!
 Safety switch, split actuator made of metal (please order separately; see accessories and spare parts)

Technical Data

Variant	8070/2-1 8070/2-2 8070/2-5	8070/2-1-AZ-U60	8070/2-3 8070/2-4	8070/2-3-AZ-U60
Explosion Protection				
IECEX gas explosion protection	Ex db eb IIC T6 Gb	Ex db eb IIC T6 Gb	Ex db eb IIC T6 Gb	Ex db eb IIC T6 Gb
IECEX dust explosion protection	Ex tb IIIC T80 °C Db	Ex tb IIIC T80 °C Db	Ex tb IIIC T80 °C Db	Ex tb IIIC T80 °C Db
ATEX gas explosion protection	⊕ II 2 G Ex db eb IIC T6 Gb	⊕ II 2 G Ex db eb IIC T6 Gb	⊕ II 2 G Ex db eb IIC T6 Gb	⊕ II 2 G Ex db eb IIC T6 Gb
ATEX dust explosion protection	⊕ II 2 D Ex tb IIIC T80 °C Db	⊕ II 2 D Ex tb IIIC T80 °C Db	⊕ II 2 D Ex tb IIIC T80 °C Db	⊕ II 2 D Ex tb IIIC T80 °C Db
Certificates	ATEX (BVS), Canada (CSA), China (CQST), IECEx (BVS), India (PESO), Korea (KGS), USA (CSA)	ATEX (BVS), Canada (CSA), China (CQST), IECEx (BVS), India (PESO), USA (CSA)	ATEX (BVS), Canada (CSA), China (CQST), IECEx (BVS), India (PESO), Korea (KGS), USA (CSA)	ATEX (BVS), Canada (CSA), China (CQST), IECEx (BVS), India (PESO), USA (CSA)
Declaration of Conformity	ATEX (EUK), ATEX (Simple apparatus), Declaration of Conformity (ATEX)	ATEX (EUK), ATEX (Simple apparatus), Declaration of Conformity (ATEX)	ATEX (EUK), ATEX (Simple apparatus), Declaration of Conformity (ATEX)	ATEX (EUK), ATEX (Simple apparatus), Declaration of Conformity (ATEX)
Electrical Data				
Rated operational voltage DC	125 V	125 V	125 V	125 V
AC operating voltage (equal potential)	500 V	500 V	400 V	400 V
AC operating voltage (unequal potential)	250 V	250 V	250 V	250 V
Rated insulation voltage	500 V	500 V	500 V	500 V
Rated insulation voltage note	(for simple apparatus: 40 V)	(for simple apparatus: 40 V)	(for simple apparatus: 40 V)	(for simple apparatus: 40 V)
Rated operational current max.	4 A	4 A	4 A	4 A
Rated operational current note	(for simple apparatus: 200 mA; inductance L and capacitance C _e are negligible)	(for simple apparatus: 200 mA; inductance L and capacitance C _e are negligible)	(for simple apparatus: 200 mA; inductance L and capacitance C _e are negligible)	(for simple apparatus: 200 mA; inductance L and capacitance C _e are negligible)
Electrical service life	Max. 10 ⁶ operating cycles	Max. 10 ⁶ operating cycles	Max. 10 ⁶ operating cycles	Max. 10 ⁶ operating cycles
Mechanical service life	Max. 10 ⁶ operating cycles	Max. 10 ⁶ operating cycles	Max. 10 ⁶ operating cycles	Max. 10 ⁶ operating cycles
Rated surge voltage	6 kV	6 kV	6 kV	6 kV
Short-circuit protection, max.	6 A	6 A	6 A	6 A
Maximum operating frequency	1800 operating cycles/h	1800 operating cycles/h	1800 operating cycles/h	1800 operating cycles/h
Ambient Conditions				
Ambient temperature	-60 °C ... +55 °C (Max. 4 A) -20 °C ... +60 °C (IP67 (EN 60529)) (Max. 2 A) -60 °C ... +60 °C (Max. 2 A)	-50 °C ... +55 °C (Max. 4 A) -20 °C ... +60 °C (IP67 (EN 60529)) (Max. 2 A) -50 °C ... +60 °C (Max. 2 A)	-60 °C ... +55 °C (Max. 4 A) -20 °C ... +60 °C (IP67 (EN 60529)) (Max. 2 A) -60 °C ... +60 °C (Max. 2 A)	-50 °C ... +55 °C (Max. 4 A) -20 °C ... +60 °C (IP67 (EN 60529)) (Max. 2 A) -50 °C ... +60 °C (Max. 2 A)
Ambient temperature	-60 °C ... +55 °C (Max. 4 A) -60 °C ... +60 °C (Max. 2 A)	-50 °C ... +55 °C (Max. 4 A) -50 °C ... +60 °C (Max. 2 A)	-60 °C ... +55 °C (Max. 4 A) -60 °C ... +60 °C (Max. 2 A)	-50 °C ... +55 °C (Max. 4 A) -50 °C ... +60 °C (Max. 2 A)
Mechanical Data				
Degree of protection (IP)	IP66	IP66	IP66	IP66
Degree of protection (IP) (IEC 60529)	IP67	IP67	IP67	IP67
Degree of protection (IP) IEC 60529) note	down to -20 °C	down to -20 °C	down to -20 °C	down to -20 °C
Enclosure material	Thermoplast GF, impact resistant	Thermoplast GF, impact resistant	Thermoplast GF, impact resistant	Thermoplast GF, impact resistant
Cover material	Duroplast GF, impact resistant	Duroplast GF, impact resistant	Duroplast GF, impact resistant	Duroplast GF, impact resistant

Technical Data				
Variant	8070/2-1 8070/2-2 8070/2-5	8070/2-1-AZ-U60	8070/2-3 8070/2-4	8070/2-3-AZ-U60
Mechanical Data				
Contact material	Silver-nickel	Silver-nickel	Silver-nickel	Silver-nickel
Finely stranded connection cross section	0.75-1.5 mm ²	0.75-1.5 mm ²	0.75-1.5 mm ²	0.75-1.5 mm ²
Solid connection cross section	0.75-1.5 mm ²	0.75-1.5 mm ²	0.75-1.5 mm ²	0.75-1.5 mm ²
Contact system	2-pole, galvanically separated, with double break	2-pole, galvanically separated, with double break	2-pole, galvanically separated, with double break	2-pole, galvanically separated, with double break
Contact opening	≥ 1.5 mm (isolating distance ≥ 3 mm)	≥ 1.5 mm (isolating distance ≥ 3 mm)	≥ 1.5 mm (isolating distance ≥ 3 mm)	≥ 1.5 mm (isolating distance ≥ 3 mm)
Seal	Silicone	Silicone	Silicone	Silicone
Components				
Cable glands and entries	1 x M20 Ø 7 to 13 mm	1 x M20 Ø 7 to 13 mm	1 x M20 Ø 7 to 13 mm	1 x M20 Ø 7 to 13 mm
Cable entry material	Polyamide	Polyamide	Polyamide	Polyamide
Material cable gland	Polyamide, Glass fibre reinforced	Polyamide, Glass fibre reinforced	Polyamide, Glass fibre reinforced	Polyamide, Glass fibre reinforced

Technical Drawings – Subject to Alterations

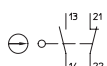

Slow-action contact, 1 NC + 1 NO
8060/-1; 807./2-1

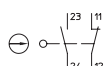

Snap-action contact, 1 NC + 1 NO
8060/-2; 807./2-2

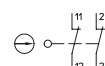



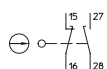



Slow-action contact, 2 NCs
8060/-3; 807./2-3

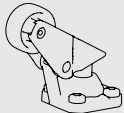

Slow-action contact, 1 NC + 1 NO, overlapping
8060/-5; 807./2-5

Accessories

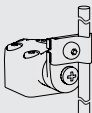
Figure	Description	Art. No.	Weight
Actuator			
	Straight actuator, for 8070/2-.-AZ	258607	100 g
	Bent actuator, for 8070/2-.-AZ	258608	100 g
	Movable actuator, for 8070/2-.-AZ	258609	100 g
Plastic cable gland			
	8161/7-M20-1307, Ex e Plastic, M20 x 1.5, cable outer diameter 7 to 13 mm Lot size 50 pieces	239172	13 g

Spare Parts			
Figure	Description	Art. No.	Weight
Actuator			
	Roller plunger actuator	258602	100 g
	Spring rod head actuator	258605	100 g
	Roller lever actuator	258603	100 g
	Parallel lever actuator	258604	100 g
	Rotary lever actuator	275368	40 g
	Adjustable rotary lever actuator	275370	80 g
	Rod lever actuator	275369	-
	Safety switch actuator	258606	100 g
Contact element			
	1 NC + 1 NO slow-action contact 8080/1-1	132529	25 g
	1 NC + 1 NO snap-action contact 8080/1-2	279482	25 g
	2 NC slow-action contact 8080/1-3	132532	25 g

The cable gland is included in the delivery.

Lot size: Purchase order quantity in [no. of units]; the delivery quantity is automatically rounded to the lot size.

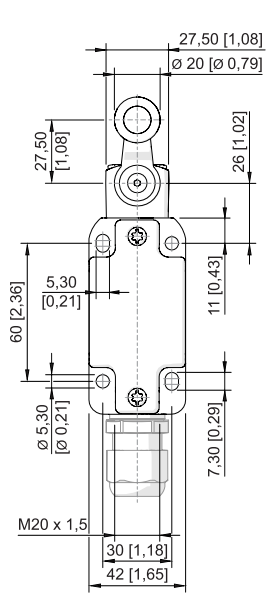

Swivelling lever 8070/2--D-U60

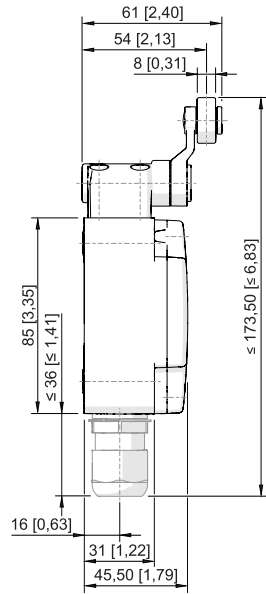

Rod lever 8070/2-DD-U60

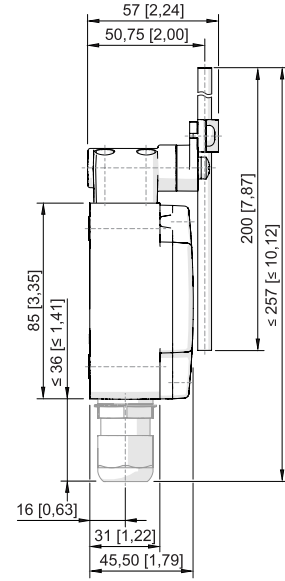

Swivelling lever 8070/2--DS-U60

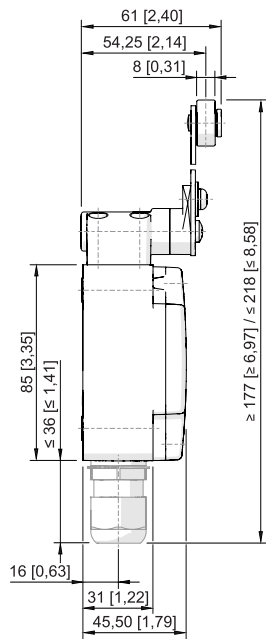

Roller plunger 8070/2--R-U60

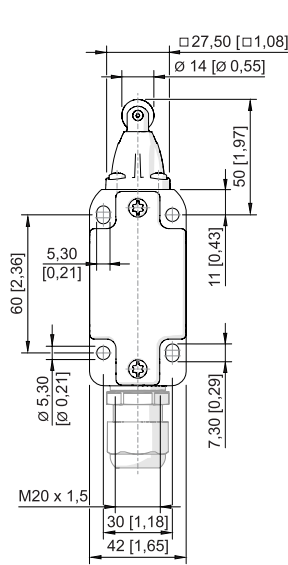

E4

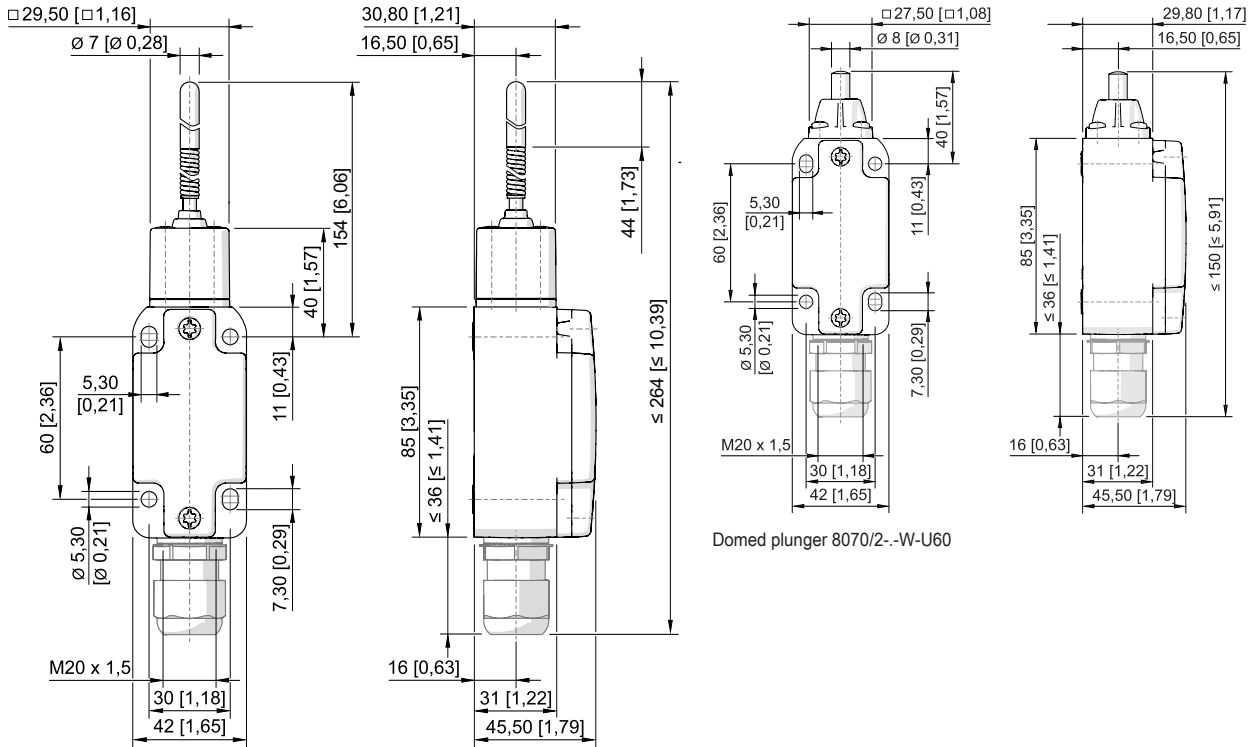

Spring rod 8070/2.-TK-U60

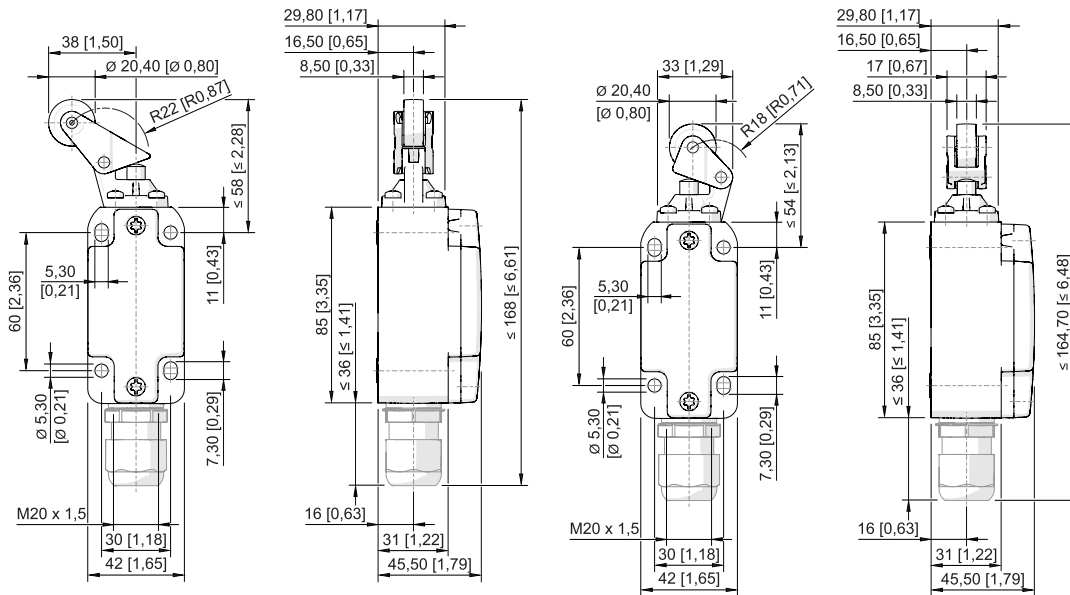

Roller lever 8070/2.-WPH-U60

Roller lever 8070/2.-WH-U60