

8562/53-2025-060 Art. No. 276592



- Non-adjustable thermal and magnetic releases
- Isolating function in accordance with EN 60947-2
- Energy limiting class 3

MY R. STAHL 8562B



R. STAHL Series 8562 miniature circuit breakers boast good current limiting for short circuits and a high switching capacity of 6 or 10 kA. This results in a low load on conductors and a high selectivity for upstream fuses. The components have a modular design and are therefore available in 1- to 4-pole versions and for nominal currents from 0.5 to 40 A.

## Technical Data

### Explosion Protection

Application range (zones)	1, 2
IECEX gas explosion protection	Ex de IIC Gb
IECEX firedamp protection	Ex de I Mb
ATEX gas explosion protection	II 2 G Ex de IIC Gb
ATEX firedamp protection	I M2 Ex de I Mb
Certificates	ATEX (PTB), Brazil (ULB), China (CQST), IECEX (PTB)

### Electrical Data

Type of voltage	AC/DC
AC rated operational voltage	400 V
DC rated operational voltage	110 V
Rated operational current	6 A
Rated operational current	6 A
Rated switching capacity	10 kA
Auxiliary contacts	Error signal
Auxiliary contacts 2	1 change-over contact
No. of poles	2
N-pole present	No
Tripping characteristic	B

### Ambient Conditions

Ambient temperature	-20 °C ... 60 °C
---------------------	------------------

### Mechanical Data

Degree of protection (IP)	IP20
Enclosure material	Epoxy resin
Width	72 mm
Width	72 mm
Width, inches	2.83 in
Length	156 mm

8562/53-2025-060 Art. No. 276592

### Mechanical Data

Length in inches	6.14 in
Mounting depth	117 mm
Mounting depth in inches	4.61 in
Weight	-

### Technical Drawings – Subject to Alterations



2-pole



Fault signal contact 1 change-over contact for error signal  
 (only for types 8562/54-2465-160-4 and 8562/54-2475-4: After the switch trips, the fault message contact can be reset manually)

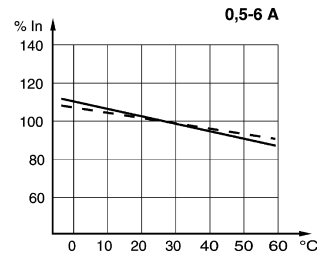

Correction factors for ambient temperatures which deviate from 30 °C

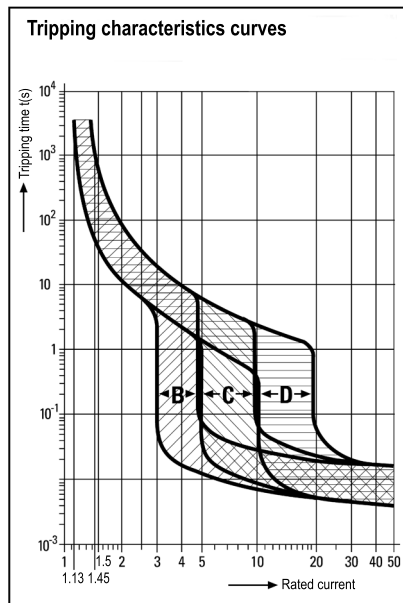

### Dimensional Drawings (All Dimensions in mm [inches]) – Subject to Alterations

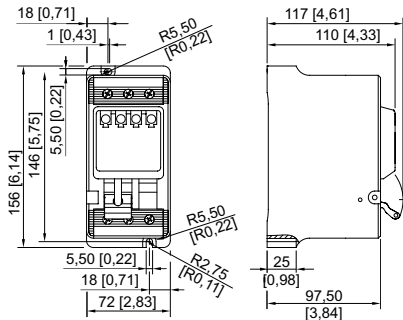

8562/53

We reserve the right to make alterations to the technical data, dimensions, weights, designs and products available without notice. The illustrations cannot be considered binding.