

6050/604-401-7B2-200822-000 Art. No. 276991



- Extremely compact universal light fitting with 4 power classes
- Can be used as a ceiling light fitting, pendant light fitting or floodlight
- Three light distribution curves available: Ultra-wide-beam, wide-beam and medium-wide-beam
- Glare-free thanks to opaque light fitting covering
- Quick, easy installation thanks to Ex e connection chamber
- Universally suitable for use in particularly cold environments as cold as -55 °C
- Suitable for particularly high ambient temperatures up to +70 °C

MY R. STAHL 6050C



The 6050/6 universal spotlight is equipment used for lighting areas, work equipment and objects. It can be used indoors and outdoors. The clear lens is available in a matted version to limit the glare. Using an internal reflector, the universal spotlight can be adapted as a narrow beam, wide beam or a medium-wide beam to suit the lighting task.

Technical Data

Explosion Protection	
Application range (zones)	1, 2, 21, 22
IECEX gas explosion protection	Ex db eb op is IIC T4 Gb
IECEX dust explosion protection	Ex tb op is IIIC T110 °C Db
ATEX gas explosion protection	Ex II 2 G Ex db eb op is IIC T4 Gb
ATEX dust explosion protection	Ex II 2 D Ex tb op is IIIC T110 °C Db
Certificates and approvals	ATEX IECEX UKEX
Certificates	ATEX (BVIS), Brazil (ULB), IECEX (BVIS)
Ship approval	DNV
Declaration of conformity	ATEX (EUK)
Electrical Data	
AC rated operational voltage	220 ... 240 V
Frequency range	50 – 60 Hz
Interfaces	DALI
Start-up current	I _{peak} = 57 A, Delta t = 210 µs
Lighting Data	
Number of lamps	1
Lamp wattage	40 W
Lamp type	LED
Lamp	LED
Light colour	2200 K – extra-warm white
Light distribution	Wide beam
Luminaire efficacy	93 lm/W
Luminous flux	4700 lm
Colour rendering	≥ 80
Colour temperature	2200 K

6050/604-401-7B2-200822-000 Art. No. 276991

Ambient Conditions

Ambient temperature -40 °C ... +70 °C

Mechanical Data

Version	Ceiling mounting
Degree of protection (IP)	IP66 / IP68 (10 m)
IP degree of protection (IEC 60598)	IP66/IP68
Enclosure material	Aluminium, Seawater-resistant
Enclosure colour	Standard
Sealing material	Silicone
Silicone-free content	Contains silicone
Protective glass material 2	Pressed glass
Max. solid connection terminals	6 mm ²
Max. finely stranded connection terminals	4 mm ²
Type of connection cable	Finely stranded Finely stranded with clip Solid
Size	1
Width	260 mm
Height	194.5 mm
Length	310 mm
Reflector	No
Disconnection of the luminaire	No
Weight	6.8 kg
Weight	14.99 lb

Components

Cable glands and entries	1 x M25 x 1.5
Stopping plugs	1 x M25 x 1.5
Wire guard	No

Technical Drawings – Subject to Alterations



Luminous flux decrease at ambient temperature - variants with DALI

6050/604-401-7B2-200822-000 Art. No. 276991



Luminous flux decrease at ambient temperature - variants without DALI

Light Distribution Curves



cd/klm $\eta = 100\%$
 — C0 - C180 — C90 - C270

Without internal reflector, protection glass diffuse

Dimensional Drawings (All Dimensions in mm [inches]) – Subject to Alterations

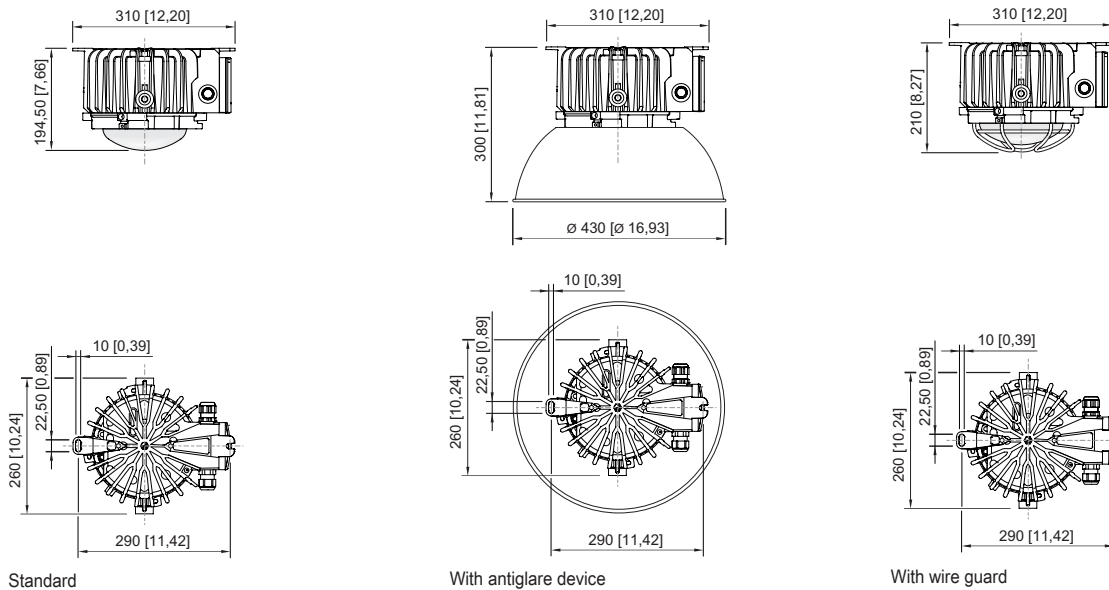

Standard

With antiglare device

With wire guard

6050/604-401-7B2-200822-000 Art. No. 276991

Accessories

Breather

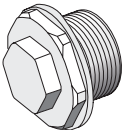
		Art. No.
	Thread: M20 x 1.5 (1 piece); for installation in light fittings; made from stainless steel; without jam nut	323702
	Thread: M25 x 1.5 (1 piece); for installation in light fittings; made from stainless steel; without jam nut	296608

Mounting bracket

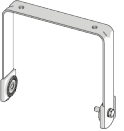
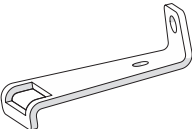
		Art. No.
	Complete; made from stainless steel (for subsequent self-mounting) For 6050/6	265877
	The stainless steel mounting fixture is fastened to the enclosure of the pendant light fitting series 6050/6 by means of two stainless steel screws M8.	269716

Pipe clamp

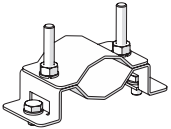
		Art. No.
	for pipe R 1 1/4" to 2"	268967

Plastic cable gland

		Art. No.
	8161/7-M25-1707 7 to 17 mm ² 1 piece	229918
	8161/7-M25-1707, Ex e Plastic, M25 x 1.5, cable outer diameter 7 to 17 mm Lot size 50 pieces	239157

Ring bolt

		Art. No.
	M8, für 6050/6, direct mounting; 1 pair	265874
	M10, direct mounting in insert nuts; 1 pair	118560

Stopping plug

		Art. No.
	8290/3-M25 Plastic, M25 x 1.5 Lot size 1 piece	143524

Wire guard

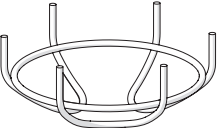
		Art. No.
	Complete with mounting parts Material: Stainless steel wire For 6050/6	221774

We reserve the right to make alterations to the technical data, dimensions, weights, designs and products available without notice. The illustrations cannot be considered binding.