

Installation equipment

Wall-mounting socket 125 A



8581/31-507 Art. No. 277858



- Reliable load disconnect switch with easily visible, lockable handle and switching position display
- An integrated auxiliary contact for control and signalling purposes, can optionally be enhanced with pluggable, easily retrofittable Ex e or Ex i auxiliary contacts
- Wide temperature range for use
- High mechanical impact and shock resistance
- Perfect protection against the ingress of liquids and dust
- 3D data available to download from the website

MY R. STAHL 8581A



R. STAHL Series 8581/31 sockets for Zone 1/21 in a 4- and 5-pole version have full AC-3 switching capacity up to 125 A. The high degree of protection IP66 guarantees the highest level of protection against the penetration of dust and water in any application position. Self-cleaning lamellar contacts provide optimum contact and the plugs can be inserted and removed in the zero position quickly and easily. The load disconnect switch, with mechanical locking device and a handle that can be locked in the 0 or I position, is an additional safety feature.

Technical Data

Explosion Protection

Scope of validity	European Union (ATEX) IECEX China (CQST)
Scope of validity Note	Other country markings available on request
Application range (zones)	1 2 21 22
IECEX gas certificate	IECEX PTB 06.0034
IECEX gas explosion protection	Ex db eb IIC T6 ... T5 Gb
IECEX dust certificate	IECEX PTB 06.0034
IECEX dust explosion protection	Ex tb IIIC T65 °C / T85 °C Db
ATEX gas certificate	PTB 01 ATEX 1161
ATEX gas explosion protection	Ex II 2 G Ex db eb IIC T6 ... T5 Gb
ATEX dust certificate	PTB 01 ATEX 1161
ATEX dust explosion protection	Ex II 2 D Ex tb IIIC T65 °C / T85 °C Db
Certificates	ATEX (PTB), Brazil (ULB), China (CQST), IECEX (PTB), Korea (KGS), Taiwan (ITRI)
Declaration of Conformity	ATEX (EGK), China (CCC)

Electrical Data

Rated operational voltage AC	277/480 to 288/500 V AC
Rated operational current	max. 125 A
Electrical service life	> 2x10 ⁴ switching cycles
Mechanical service life	> 2x10 ⁴ switching cycles
Type of voltage	Low voltage
Switching capacity main contacts	AC-3: 690 V, 125 A
Auxiliary contacts	2 (1 NO + 1 NC)

Installation equipment

Wall-mounting socket 125 A



8581/31-507 Art. No. 277858

Electrical Data

Frequency range	50 / 60 Hz
-----------------	------------

Device Specific Data

Back-up fuse with thermal protection	160 A gG
--------------------------------------	----------

Back-up fuse without thermal protection	125 A gG
---	----------

Ambient Conditions

Ambient temperature	-45 °C to +60 °C
---------------------	------------------

Ambient temperature	-49 °F to +140 °F
---------------------	-------------------

Ambient temperature note	For further information, see the operating instructions.
--------------------------	--

Mechanical Data

Degree of protection IP (IEC 60529)	IP66
-------------------------------------	------

IP degree of protection (IEC 60079)	IP66
-------------------------------------	------

Enclosure material	Polyester, Glass fibre reinforced
--------------------	-----------------------------------

Silicone-free	No
---------------	----

Multiple conductor connection	2 x 35 mm ² to 2 x 50 mm ²
-------------------------------	--

Multiple conductor connection AWG	2 x AWG 2 ... 2 x AWG 1/0
-----------------------------------	---------------------------

Finely stranded connection cross-section	1 x 50 mm ² ... 1 x 150 mm ²
--	--

Finely stranded connection cross-section AWG	1 x AWG 1/0 ... 1 x AWG 300 kcmil
--	-----------------------------------

Stranded connection cross-section	1 x 35 mm ² ... 1 x 150 mm ²
-----------------------------------	--

Stranded connection cross-section AWG	1 x AWG 2 ... 1 x AWG 300 kcmil
---------------------------------------	---------------------------------

Width	270 mm
-------	--------

Width in inches	10.63 in
-----------------	----------

Height	296 mm
--------	--------

Height, inches	11.65 in
----------------	----------

Length	563 mm
--------	--------

Length, inches	22.18 in
----------------	----------

Impact strength (IEC 60079)	7 J
-----------------------------	-----

Impact strength (IEC 62262)	IK10
-----------------------------	------

Colour code	Black
-------------	-------

Coding (clock hour position)	7
------------------------------	---

Lockable in	in 0- and I-position
-------------	----------------------

Series	SolConeX
--------	----------

Detailed number of poles	3 P + N + PE
--------------------------	--------------

Weight	20.5 kg
--------	---------

Weight	45.19 lb
--------	----------

Mounting / Installation

Connection	Screw terminal
------------	----------------

Components

Cable entry note	Entry 1: Lower left Entry 2: Lower right
------------------	---

Entry 1 model	8161/7-M63-4828-LT
---------------	--------------------

Entry 1 type	Polyamide cable gland
--------------	-----------------------

Entry 1	M63 x 1.5
---------	-----------

Entry 1 terminal area	28 – 48 mm
-----------------------	------------

Entry 1 clamping range, inch	1.1 – 1.89 in
------------------------------	---------------

Installation equipment

Wall-mounting socket 125 A



8581/31-507 Art. No. 277858

Components

Metal entry possible 1	No
Entry 2 model	8290/3-M63
Entry 2 type	Polyamide stopping plug
Entry 2	M63 x 1.5
Metal entry possible 2	No
Entry 3 model	8290/3-M25
Entry 3 type	Polyamide stopping plug
Entry 3	M25
Metal entry possible 3	No

Technical Drawings – Subject to Alterations

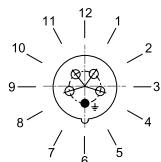

Position of clock hour position
Example: 6 h position

Dimensional Drawings (All Dimensions in mm [inches]) – Subject to Alterations

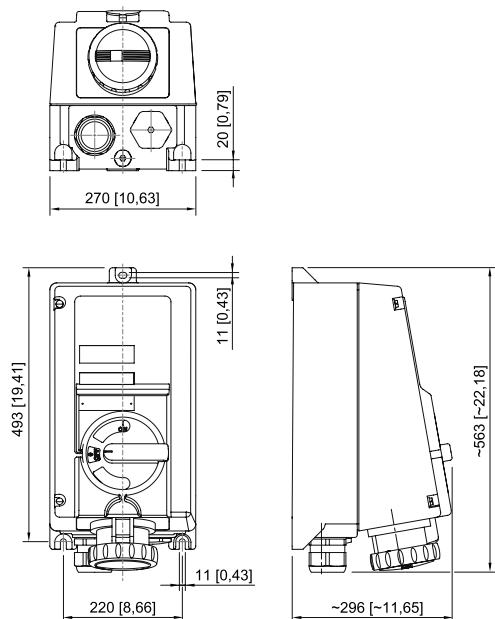

Wall-mounting socket

Accessories

Auxiliary contact

Art. No.

Installation equipment

Wall-mounting socket 125 A



8581/31-507 Art. No. 277858

	2 NC (8080/1-3) 250 V AC/DC Max. 6 A 1.5 to 2.5 mm ² , solid/finely stranded The switching function of the auxiliary contact depends on the installation slot used. Left and right: Synchronising	168356
	1 NC + 1 NO (8080/1-1) 250 V AC/DC Max. 6 A 1.5 to 2.5 mm ² , solid/finely stranded The switching function of the auxiliary contact depends on the installation slot used. Left: Delayed (ON), leading (OFF) Right: Synchronising	168351
	2 NO (8080/1-4) 250 V AC/DC Max. 6 A 1.5 to 2.5 mm ² , solid/finely stranded The switching function of the auxiliary contact depends on the installation slot used. Left and right: Synchronising	168353

Cable gland made of plastic

Art. No.

	8161/7-M25-1707, Ex e Plastic, M25 x 1.5, cable outer diameter 7 to 17 mm Lot size 50 pieces	239157
---	--	--------

Ex i cover

Art. No.

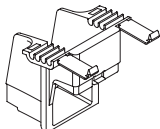
	Ex i cover for auxiliary contacts for use in Ex i electrical circuits	168855
--	---	--------

Plastic cable gland

Art. No.

	8161/7-M63-4828, Ex e Plastic, M63 x 1.5, cable outer diameter 28 to 48 mm Lot size 1 pieces	239161
--	--	--------

Stopping plug

Art. No.

	8290/3-M25 Plastic, M25 x 1.5 Lot size 1 piece	143524
	8290/3-M63 Plastic, M63 x 1.5 Lot size 1 piece	143548

Switch insert

Art. No.

	8549/1-31L load and motor switch	168776
--	----------------------------------	--------

Spare Parts

Installation equipment

Wall-mounting socket 125 A



8581/31-507 Art. No. 277858

Auxiliary contact key

Art. No.



For removing installed auxiliary contacts

201909

Repair set for Series 8581 sockets

Art. No.

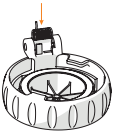

Repair set 8581 hinged cover, black

275511

We reserve the right to make alterations to the technical data, dimensions, weights, designs and products available without notice. The illustrations cannot be considered binding.