

6525/2224-1501-6014-242 Art. No. 284557



- Checked and approved in accordance with Ex ec type of protection, so vapour tightness test is not applicable
- Stainless steel enclosure as standard for a long service life and safety even under harsh ambient conditions
- Extremely wide range of ambient temperatures – between -60 °C and +60 °C
- Robust design with IK10 and IP66
- Wide-range input with optional 100 V to 277 V
- DALI versions available for lighting control, monitoring and switching

MY R. STAHL 6525C



The revised generation of LED floodlights for Zone 2 now includes a version with Ex ec type of protection especially for the European market. This eliminates the time-consuming vapour tightness test. The wide-range input now also meets the electrical installation conditions for global use. With an optional DALI interface, the floodlight paves the way to a digital lighting solution. Its extremely low start-up current can also support existing installations, as the circuit breakers that are already installed do not need to be replaced.

Technical Data

Explosion Protection

Application range (zones)	2 21 22
IECEX gas certificate	IECEX EPS 15.0032
IECEX gas explosion protection	Ex db ec IIC T4 Gc
IECEX dust certificate	IECEX EPS 15.0032
IECEX dust explosion protection	Ex tb op is IIIC T100 °C Db
ATEX gas certificate	EPS 15 ATEX 1 991
ATEX gas explosion protection	Ex II 3 G Ex db ec IIC T4 Gc
ATEX dust certificate	EPS 15 ATEX 1 991
ATEX dust explosion protection	Ex II 2 D Ex tb op is IIIC T100 °C Db
Certificates	ATEX (BVIS), IECEX (BVIS), India (PESO)
Declaration of Conformity	ATEX (EUK)

Electrical Data

Rated operational voltage AC	110 – 277 V
Frequency range	50 – 60 Hz

Lighting Data

Lamp wattage	100 W
Lamp type	LED
Lamp	LED
Light colour	Warm white
Light distribution	Wide beam
Luminaire efficacy	102 lm/W
Luminous flux	10455 lm
Colour rendering	≥ 80

6525/2224-1501-6014-242 Art. No. 284557

Lighting Data

Colour temperature	4000 K
--------------------	--------

Ambient Conditions

Ambient temperature	-50 °C ... +60 °C
Storage temperature	-40 °C ... +75 °C

Mechanical Data

Degree of protection (IP)	IP66
Class	I
Enclosure material	Stainless steel 1.4404, Powder-coated Double powder-coated
Enclosure colour	Similar to RAL 9010
Sealing material	Silicone
Pane material	Reinforced glass
Max. solid connection terminals	6 mm ²
Max. finely stranded connection terminals	4 mm ²
Type of connection cable	Finely stranded Solid
Width	400 mm
Height	70 mm
Length	520 mm
Impact strength (IEC 62262)	IK10
Fastening	With bracket, SS316L
Weight	16 kg
Weight	35.27 lb

Mounting / Installation

Note about mounting	Provided
---------------------	----------

Components

Drilled holes	3 x M25
Cable glands and entries	CMP-25A2F 1 x M25 x 1.5
Material cable gland	Nickel-plated brass
Stopping plugs	2 x M25 x 1.5
Stopping plug material	Polyamide, black

6525/2224-1501-6014-242 Art. No. 284557

Light Distribution Curves

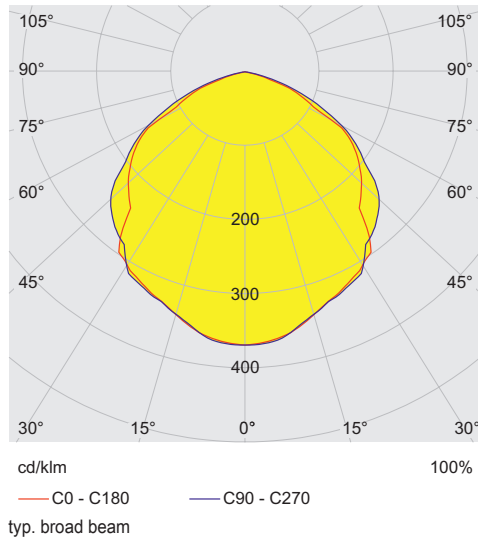

Dimensional Drawings (All Dimensions in mm [inches]) – Subject to Alterations

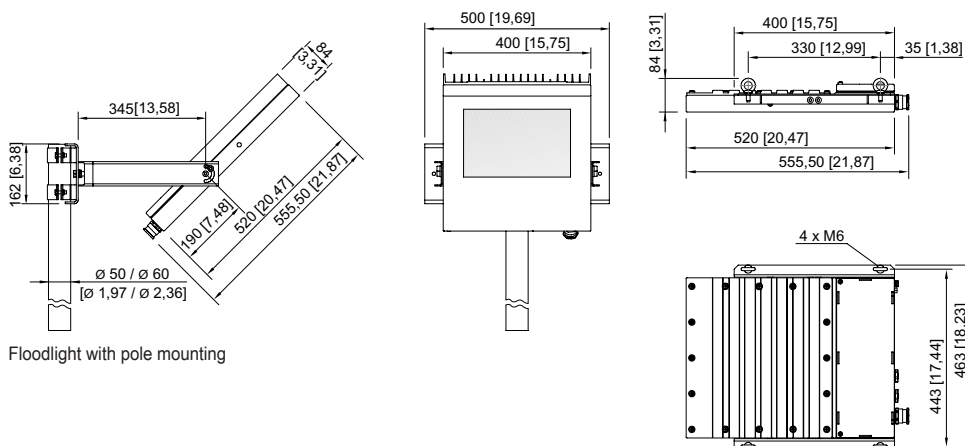
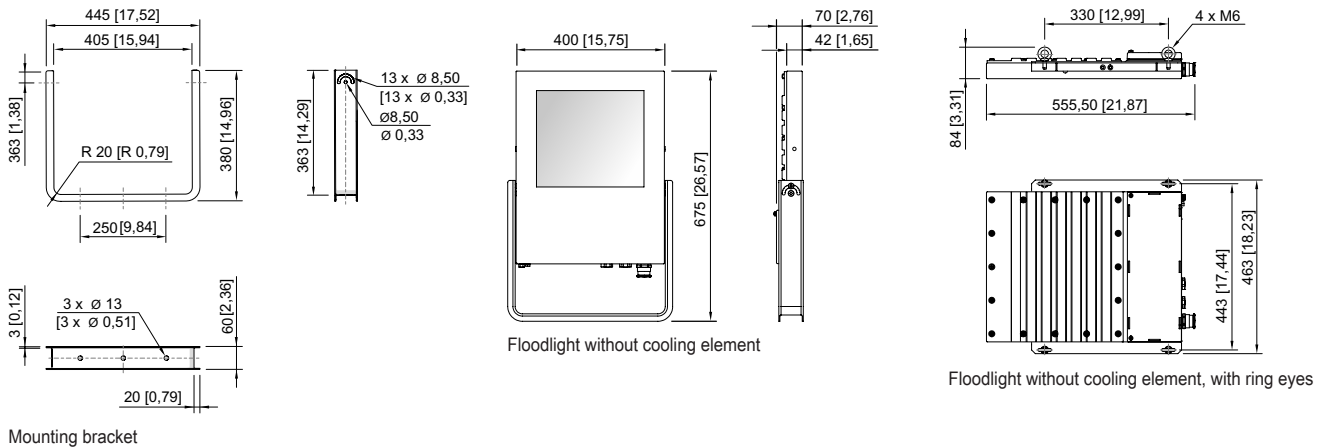

6525/2224-1501-6014-242 Art. No. 284557



6525/2224-1501-6014-242 Art. No. 284557

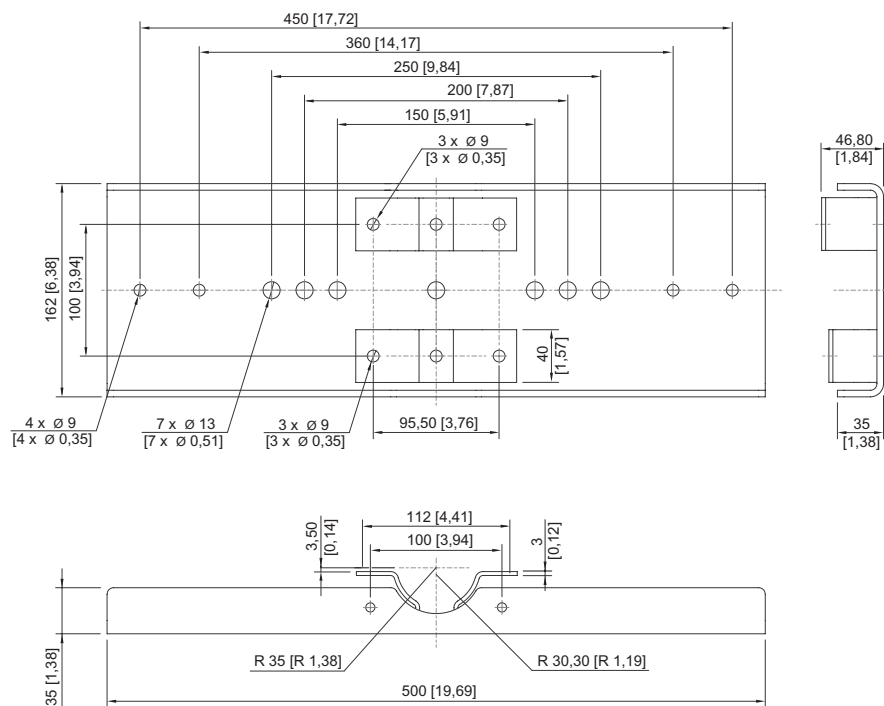

Accessories

Mounting set

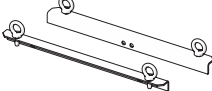
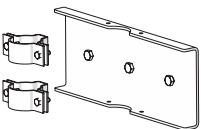
		Art. No.
	for pendant mounting with ring bolts included - stainless steel SS316L (1.4404 or V4A) without powder coating	257464
	for pole mounting with pole diameter of 50 mm - stainless steel SS316L (1.4404 or V4A) without powder coating	283361
	for pole mounting with pole diameter of 60 mm - stainless steel SS316L (1.4404 or V4A) without powder coating	263824

Ring bolt

		Art. No.
	M6 (4 pieces), direct mounting in insert nuts	254234

Mounting bracket

		Art. No.
	Sheet steel, single powder coated	244604
	Stainless steel SS316L (1.4404 or V4A) without powder coating	221589

We reserve the right to make alterations to the technical data, dimensions, weights, designs and products available without notice. The illustrations cannot be considered binding.