

8562/53-2048-020 Art. No. 285195



- Non-adjustable thermal and magnetic releases
- Isolating function in accordance with EN 60947-2
- Energy limiting class 3

MY R. STAHL 8562B



R. STAHL Series 8562 miniature circuit breakers boast good current limiting for short circuits and a high switching capacity of 6 or 10 kA. This results in a low load on conductors and a high selectivity for upstream fuses. The components have a modular design and are therefore available in 1- to 4-pole versions and for nominal currents from 0.5 to 40 A.

Technical Data

Explosion Protection	
Application range (zones)	1, 2
IECEX gas explosion protection	Ex de IIC Gb
IECEX firedamp protection	Ex de I Mb
ATEX gas explosion protection	II 2 G Ex de IIC Gb
ATEX firedamp protection	I M2 Ex de I Mb
Certificates	ATEX (PTB), Brazil (ULB), China (CQST), IECEX (PTB)
Electrical Data	
Type of voltage	AC/DC
AC rated operational voltage	400 V
DC rated operational voltage	110 V
Rated operational current	2 A
Rated operational current	2 A
Rated switching capacity	10 kA
Auxiliary contacts	2 NO
No. of poles	2
N-pole present	No
Tripping characteristic	C
Ambient Conditions	
Ambient temperature	-20 °C ... 60 °C
Mechanical Data	
Degree of protection (IP)	IP20
Enclosure material	Epoxy resin
Width	72 mm
Width	72 mm
Width, inches	2.83 in
Length	156 mm
Length in inches	6.14 in

8562/53-2048-020 Art. No. 285195

Mechanical Data

Mounting depth	117 mm
Mounting depth in inches	4.61 in
Weight	1.5 kg
Weight	3.31 lb

Technical Drawings – Subject to Alterations



2-pole

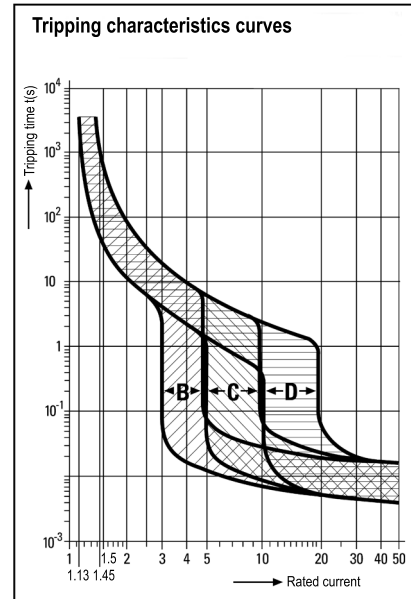
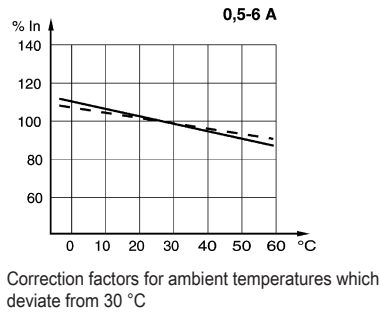

Auxiliary contact 1 NO
Fault signal contact 1 NO

Dimensional Drawings (All Dimensions in mm [inches]) – Subject to Alterations

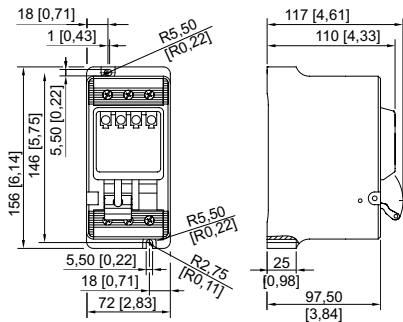

8562/53

We reserve the right to make alterations to the technical data, dimensions, weights, designs and products available without notice. The illustrations cannot be considered binding.