

8595/1-CP1-S-P15-012 Art. No. 286569



- Simple handling using hot swap technology
- Versatile application possibilities thanks to modular structure
- Most extreme operating conditions in hazardous areas
- Reliable data and signal connections or power supplies
- Simple connection and disconnection thanks to one-handed operation

MY R. STAHL 8595C



R. STAHL's Series 8595/1 explosion-protected miniCON plug connectors with up to eight poles keep you safely connected. The high-quality plastic or stainless steel plug connectors have impressed many customers with their reliability and versatility in application. Their hot swap disconnecting capacity means that intrinsically safe signal supplies and power supplies up to 500 V/16 A can be connected and disconnected reliably and safely without the need for a hot work permit or other hot work authorisation. The miniCON connectors designed for conductor cross-sections of 0.25 mm² to 2.5 mm² are available for directly connecting electrical lines or for device installation in the device plug and flange socket types of construction. The new plug connectors for hazardous areas in Zones 1 and 21 stand out from the competition thanks to their modular structure and logically arranged components, which enable quick, easy mounting. Our patented single-handed operation means that matching plug connectors, which can be defined by the installer using internal coding for up to three applications, can be connected in no time.

Technical Data

Explosion Protection

Area of application	European Union (ATEX) IECEX
Application range (zones)	1, 2, 21, 22
IECEX gas certificate	IECEX EPS 20.0035X
IECEX gas explosion protection	Ex db eb IIC T6 / T5 Gb
IECEX gas explosion protection 2	Ex ia IIC T6 Ga
IECEX dust certificate	IECEX EPS 20.0035X
IECEX dust explosion protection	Ex tb IIIC T80 °C / T95 °C Db
IECEX dust explosion protection 2	Ex ia IIIC T80 °C Da
ATEX gas explosion protection	Ex II 2 G Ex db eb IIC T6 / T5 Gb
ATEX gas explosion protection 2	Ex II 1 G Ex ia IIC T6 Ga
ATEX dust explosion protection	Ex II 2 D Ex tb IIIC T80 °C / T95 °C Db
ATEX dust explosion protection 2	Ex II 1 D Ex ia IIIC T80 °C Da
Certificates	ATEX (EPS), IECEX (EPS)
Declaration of conformity	ATEX (EUK)

Electrical Data

Rated operational voltage AC	500 V
Rated operational voltage DC	max. 110 V
Voltage tolerance	+10%
Rated insulation voltage	690 V

8595/1-CP1-S-P15-012 Art. No. 286569

Electrical Data

Rated operational current for AC	16 A
Rated operational current for DC	8 A
Rated operational current for DC 2	16 A
No. of poles	7
No. of poles note	Eight contacts are included in the delivery as standard. One to eight contacts can be used.
AC frequency range	50 – 60 Hz

Device Specific Data

Back-up fuse with thermal protection	25 A GL
Back-up fuse without thermal protection	16 A GL

Ambient Conditions

Ambient temperature	-60 °C ... 75 °C
Ambient temperature	-76 °F ... +167 °F

Mechanical Data

Version	Coupling, reverse
Degree of protection (IP) (IEC 60529)	IP66 IP67
IP degree of protection (IEC 60079)	IP64
Base part	Coupling
Enclosure material	Plastic
Contact type	Pin contact
Connection cross-section	1.5 mm ²
Connection cross-section 2	0.75 – 1 mm ²
Connection cross-section AWG	16 AWG
Connection cross-section AWG	18 AWG
Connection cross-section 2 min.	0.75 mm ²
Connection cross-section 2 max.	1 mm ²
Connection cross-section 2 AWG min.	18 AWG
Connection cross-section 2 AWG max.	18 AWG
Clamping range	13 ... 17 mm
Connection thread	M25 x 1.5
Impact strength (IEC 60079)	7 J
Coding	1-3, arbitrary
Seal	Silicone
Weight	130 g
Weight	0.29 lb

Mounting / Installation

Connection type	crimp
Connection type 2	solder
Cable gland	Series 8161/7 made of plastic

Components

Protective cap fitted	Yes
-----------------------	-----

8595/1-CP1-S-P15-012 Art. No. 286569

Technical Drawings – Subject to Alterations

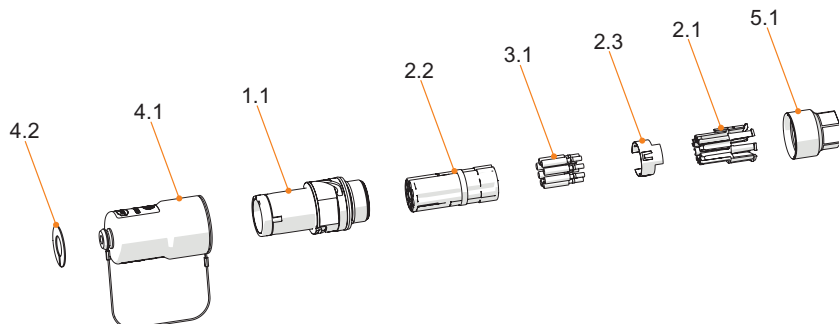

- 4.2 Code disk
- 4.1 Protective cap
- 1.1 Coupling basic part
- 2.2 Insulator
- 3.1 Contacts
- 2.3 PE contact (only for metal variant)
- 2.1 Contact holder
- 5.1 Adapter for cable gland

Dimensional Drawings (All Dimensions in mm [inches]) – Subject to Alterations

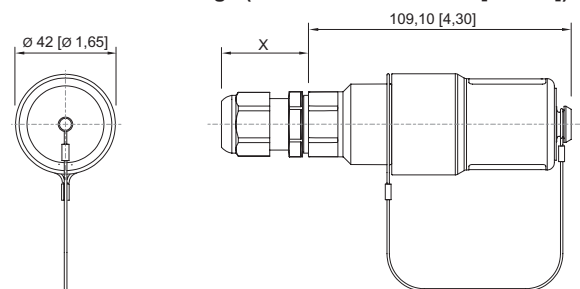





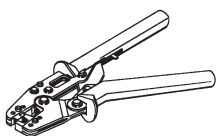
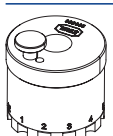

8595/1 coupling
X = depending on the cable gland used

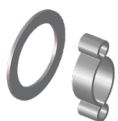
Accessories

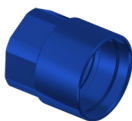

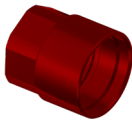
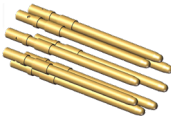
		Art. No.
Plug, reverse 	Enclosure material: Plastic Contact type: Socket contact Connection cross-section: 1.5 mm ² Number of poles: 7 P + PE/8 P Connection type: Crimping	286545
Crimping tool 	For all versions with crimp connection of 0.14 to 6 mm ²	295689
Contact mounts/positioners for rotated industrial contacts 	The selection of the contact mount is based on the crimp contacts to be processed. - Exact positioning of the crimp contact during the crimping process - Reliable, reproducible crimping result - Adapted for miniCON contacts	29586

8595/1-CP1-S-P15-012 Art. No. 286569

2-ear clamps		Art. No.
	KIT 8595 2-ear clamps, big Strain relief depending on the cable gland used Cable outer diameter 13 to 17 mm	286169
Adaptor		Art. No.
	KIT 8595 plastic adaptor, consisting of: Adaptor made of plastic for cable gland M25 x 1.5 incl. strain relief Cable outer diameter 13 to 17 mm	286163
	KIT 8595 plastic adaptor, colour: blue for cable gland, M25 x 1.5	299322
	KIT 8595 plastic adaptor, colour: green for cable gland, M25 x 1.5	299300
	KIT 8595 plastic adaptor, colour: red for cable gland, M25 x 1.5	299321
Pin contact		Art. No.
	KIT 8595 pin contacts (1.5 mm ²), 8 pieces	286157
Code disks		Art. No.
	KIT coding plate 8595, four colours, without labelling Customer-specific labelling available on request	289939
Plastic cable gland		Art. No.
	8161/7-M25-1707-LT, Ex e Polyamide, M25 x 1,5 mm, 7 – 17 mm Lot size 50 pieces	329693
	8161/8-M25-1707-LT, Ex i Polyamide, M25 x 1,5 mm, 7 – 17 mm Lot size 50 pieces	329697

8595/1-CP1-S-P15-012 Art. No. 286569

Spare Parts

		Art. No.
	Material: Nickel-plated brass One piece Thread size: M32	110869
Contact holder for pin contact		Art. No.
	KIT 8595 pin contact insert	286147
Protective cap		Art. No.
	KIT 8595 coupling protective cap (pin) Incl. KIT 8595 coding plates, four colours, without labelling	286160

We reserve the right to make alterations to the technical data, dimensions, weights, designs and products available without notice. The illustrations cannot be considered binding.