

Control and signalling devices

Control device system Series ConSig 8040

LED indicator lamp and 2-pole control switch with switch insert 8008

8040/12E8X-54C01SA70-32G02SF01 Art. No. 287012



ConSig



- Quad certified control stations (NEC®, CE Code, ATEX, IECEx)
- Lightweight enclosure made of glass fibre reinforced polyester (FRP), excellent for corrosive atmospheres
- Offers a variety of pushbuttons, illuminated pushbuttons, control switches and LEDs for different configurations
- Customisable control stations available upon request with different entry, contact options and additional certifications

MY R. STAHL 8040E



R. STAHL's series 8040 NEC® / CE Code control stations utilize explosion-protected components with non-metallic enclosures for the ultimate flexibility, safety and durability in hazardous and hostile locations. Choose from one of the standard versions or contact us for a customised solution.

Technical Data

Explosion Protection

Area of application	European Union (ATEX) Canada IECEx USA
Application range (zones)	1, 2, 21, 22
IECEx gas certificate	IECEx PTB 06.0025
IECEx gas explosion protection	Ex db eb IIC T6 Gb
IECEx dust certificate	PTB 01 ATEX 1105
IECEx dust explosion protection	Ex tb IIIC T80 °C Db
ATEX gas certificate	PTB 01 ATEX 1105
ATEX gas explosion protection	⊕ II 2 G Ex db eb IIC T6 Gb
ATEX dust certificate	PTB 01 ATEX 1105
ATEX dust explosion protection	⊕ II 2 D Ex tb IIIC T80 °C Db
Certificate ULus	E182378V1S5
Marking ULus	Class I, Div. 2, Groups A,B,C,D Class II, III, Div. 2, Groups F,G Class I, Zone 1, AEx db eb IIC T6 Enclosure Type 3, 4, 4X
Certificate cUL	E182378V1S5
Marking cUL	Ex db eb IIC T6 Class I, Div. 2, Groups A,B,C,D Class II, III, Div. 2, Groups F,G Enclosure Type 3, 4, 4X
Certificates	ATEX (PTB), Brazil (ULB), Canada (UL), China (NEPSI), IECEx (PTB), India (PESO), Korea (KGS), Taiwan (ITRI), USA (UL)
Ship approval	DNVGL
Notes	Product label for standard configurations as NEC®, CE Code, ATEX, and IECEx. For additional certifications, contact factory.

Electrical Data

AC rated operational voltage	690 V
------------------------------	-------

Control and signalling devices



Control device system Series ConSig 8040

LED indicator lamp and 2-pole control switch with switch insert 8008

8040/12E8X-54C01SA70-32G02SF01 Art. No. 287012

Electrical Data

Rated operational current	16 A
---------------------------	------

Ambient Conditions

Ambient temperature	-50 °C ... 40 °C
Ambient temperature	-58 °F ... +104 °F

Mechanical Data

Degree of protection IP (IEC 60529)	IP66
Enclosure type (UL50 & UL50E)	3, 4, 4X
Enclosure material	Polyester resin, Glass fibre reinforced
Enclosure colour	Dark grey
Silicone-free	No
Clamping range AWG	14 AWG
Connection cross-section max.	2.5 mm ²
Solid connection cross section	0.32 – 2.5 mm ²
Connection cross-section AWG single stranded	22 AWG ... 14 AWG
Finely stranded connection cross section	0.32 – 2.5 mm ²
Finely stranded connection cross-section AWG	22 AWG ... 14 AWG
Cover fixing type	With captive screws, M4 stainless steel screws
Width	80 mm
Width, inches	3.15 in
Height	139 mm
Height in inches	5.47 in
Depth	72 mm
Depth in inches	2.76 in
Seal	Silicone, foamed
Weight	1.01 kg

Mounting / Installation

Tightening torque of cover screw 1	1.4 N · m
Tightening torque of cover screw 1 lbf in	12.4 lbf in

Components

Installation position top	Indicator lamp bezel, Red, With silicone seal
Built-in element top	LED indicator lamp
Installation position bottom	Small handle, 0/OFF-I/ON (1x 90°), With silicone seal
Built-in element bottom	Control switch 002
No. poles on bot. built-in el.	2
Flange and plates	Metal plate, bottom
Cable glands and entries	NPT 3/4
Entry type	CMP
Entry 1 type	Metal adaptor
Entry 1	NPT 3/4"
Metal entry possible 1	Yes

Control and signalling devices



Control device system Series ConSig 8040

LED indicator lamp and 2-pole control switch with switch insert 8008

8040/12E8X-54C01SA70-32G02SF01 Art. No. 287012

Technical Drawings – Subject to Alterations

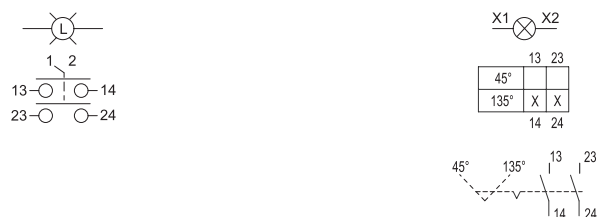

Dimensional Drawings (All Dimensions in mm [inches]) – Subject to Alterations

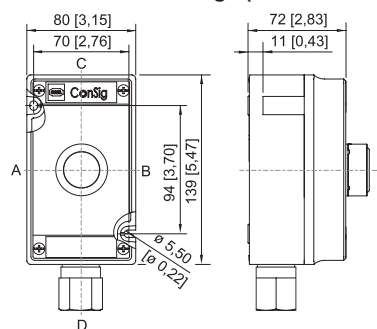

ConSig 8040/12 NEC

Accessories

Indicator lamp bezel BG054



Diameter 39 mm
All colours
Silicone-free: No

Art. No.

223123

Rotary actuator, small



Diameter 39 mm, not lockable, 90° position
Seal: Silicone, for up to -60 °C

Art. No.

264002

Spare Parts

Caps for BG054



for indicator lamp, all colours packaged

Art. No.

248685

Label holder



Size 1, without insert disc, 1-line label
for actuators Ø 39

Art. No.

223566





Control and signalling devices



Control device system Series ConSig 8040

LED indicator lamp and 2-pole control switch with switch insert 8008

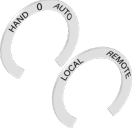
8040/12E8X-54C01SA70-32G02SF01 Art. No. 287012

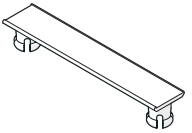
Label holder		Art. No.
	Size 2, without insert disc, 1- or 2-line label for actuators Ø 39	223567
	Size 3, without insert disc, 1-, 2- or 3-line label for actuators Ø 39	223568
Label set for BG732		Art. No.
	The label set contains three dia. 30.8 mm labels 1x label with text HAND-0-AUTO 1x label with text LOCAL-REMOTE 1x label blank	321792
Special key		Art. No.
	for tightening plastic locking nut	169101
Tag label		Art. No.
	plain for attaching to enclosure 8040; moulded material; with paper insert strip	130673

We reserve the right to make alterations to the technical data, dimensions, weights, designs and products available without notice. The illustrations cannot be considered binding.