

Control Devices

Control device system ConSig 8040 series

LED indicator lamp

8040/12E8X-54C01SA70 Art. No. 287017

STAHL

ConSig



- Quad certified control stations (NEC®, CE Code, ATEX, IECEX)
- Lightweight enclosure made from fiberglass reinforced polyester (FRP), excellent for corrosive atmospheres
- Offers a variety of pushbuttons, illuminated pushbuttons, control switches and LEDs for different configurations
- Customizable control stations available upon request with different entry, contact options and additional certifications

MY R. STAHL 8040E



R. STAHL's series 8040 NEC®/ CE Code control stations utilize explosion-protected components with non-metallic enclosures for the ultimate flexibility, safety and durability in hazardous and hostile locations. Choose from one of the standard versions or contact us for a customized solution.

Technical Data

Explosion Protection

Scope of validity	European Union (ATEX) Canada IECEX USA
Application range (zones)	1 2 21 22
IECEX gas certificate	IECEX PTB 06.0025
IECEX gas explosion protection	Ex db eb IIC T6 Gb
IECEX dust certificate	IECEX PTB 06.0025
IECEX dust explosion protection	Ex tb IIIC T80 °C Db
ATEX gas certificate	PTB 01 ATEX 1105
ATEX gas explosion protection	⊕ II 2 G Ex db eb IIC T6 Gb
ATEX dust certificate	PTB 01 ATEX 1105
ATEX dust explosion protection	⊕ II 2 D Ex tb IIIC T80 °C Db
Certificate ULus	E182378V1S5
Marking ULus	Class I, Div. 2, Groups A,B,C,D Class II, III, Div. 2, F,G Class I, Zone 1, AEx db eb IIC T6 Enclosure Type 3, 4, 4X
Certificate cUL	E182378V1S5
Marking cUL	Ex db eb IIC T6 Class I, Div. 2, Groups A,B,C,D Class II, III, Div. 2, F, G Enclosure Type 3, 4, 4X
Certificates	ATEX (PTB), Brazil (ULB), Canada (UL), China (NEPSI), IECEX (PTB), India (PESO), Korea (KGS), Taiwan (ITRI), USA (UL)
Ship approval	DNVGL

Control Devices

Control device system ConSig 8040 series

LED indicator lamp

8040/12E8X-54C01SA70 Art. No. 287017



Explosion Protection

Notes	Product label for standard configurations as NEC®, CE Code, ATEX, and IECEx. For additional certifications, contact factory.
-------	--

Electrical Data

Rated operational voltage AC	250 V
------------------------------	-------

Ambient Conditions

Ambient temperature	-50 °C ... +40 °C
Ambient temperature	-58 °F ... +104 °F

Mechanical Data

Degree of protection (IP)	IP66
Degree of protection IP (IEC 60529)	IP66
Enclosure Type (UL50 & UL50E)	3, 4, 4X
Enclosure material	Polyester resin, Glass fibre reinforced
Enclosure colour	Dark grey
Silicone-free	No
AWG clamping range	14 AWG
Connection cross-section max.	2.5 mm ²
Solid connection cross section	0.32 – 2.5 mm ²
Connection cross-section AWG single stranded	22 AWG to 14 AWG
Finely stranded connection cross section	0.32 – 2.5 mm ²
Finely stranded connection cross-section AWG	22 AWG - 14 AWG
Cover fixing type	With captive screws, M4 stainless steel screws
Width	80 mm
Width, inches	3.15 in
Height	139 mm
Height, inches	5.47 in
Depth	72 mm
Depth, inches	2.76 in
Seal	Silicone, foamed
Weight	705 g
Weight	1.55 lb

Mounting / Installation

Tightening torque of cover screw 1	1.4 Nm
Tightening torque of cover screw 1 lbf in	12.4 lbf in

Components

Installation position middle	Indicator lamp bezel, Red, With silicone seal
Built-in element middle	LED indicator lamp
Flange and plates	Metal plate, bottom
Entry type	CMP
Entry 1 type	Metal adapter
Entry 1	NPT 3/4"
Metal entry possible 1	Yes

Control Devices

Control device system ConSig 8040 series

LED indicator lamp

8040/12E8X-54C01SA70 Art. No. 287017



Dimensional Drawings (All Dimensions in mm [inches]) – Subject to Alterations

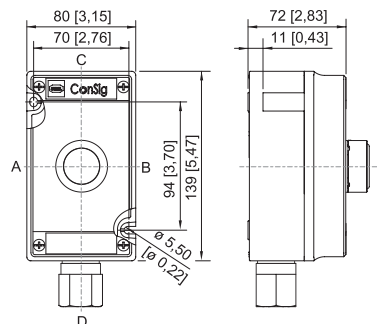

ConSig 8040/12E

Accessories

Indicator lamp bezel



Indicator lamp bezel		Art. No.
BG054		
	Diameter 39 mm All colours Silicone-free: No	223123

Spare Parts

Caps for BG054

Caps for BG054		Art. No.
	for indicator lamp, all colours packaged	248685

Label holder

Label holder		Art. No.
	Size 1, without insert disc, 1-line label for actuators Ø 39	223566
	Size 2, without insert disc, 1- or 2-line label for actuators Ø 39	223567
	Size 3, without insert disc, 1-, 2- or 3-line label for actuators Ø 39	223568

Special key

Special key		Art. No.
	for tightening plastic locking nut	169101

We reserve the right to make alterations to the technical data, dimensions, weights, designs and products available without notice. The illustrations cannot be considered binding.