

Contactors

80 A

8550/1-CT-GLS3-80-95-U1S-22 Art. No. 287707



- Safe control of motors and other loads in motor starters and power distribution boards
- Reliable protection of motors in connection with the overload relay
- Can be used globally thanks to international approvals
- Extensive flexibility thanks to wide-range coil voltages
- Large clamping range for main terminals

MY R. STAHL 8550C



The contactor for R. STAHL's 8550 series is a motor load contactor for use in motor starters up to 37 kW / 50 hp at 400 or 480 V and other performance-oriented applications. It switches AC-3, -4, -5 and -6 loads just as reliably as AC-1 operating currents. Values are also available for DC-1, -3 and -5. With just three coil voltage ranges, control voltages of 20 to 280 V are covered. Up to four auxiliary contacts are optionally available. Supplemented by the moulded case circuit breaker and overload relay also available in this series, motor starters up to 37 kW / 50 hp at 400 to 480 V are available (other powers available on request).

Technical Data

Explosion Protection

Application range (zones)	1 2
Application range (Zone) note	For use in Zone 21/22 when protected by Ex tb/tc enclosure
IECEX gas certificate	IECEX FMG 22.0005U
IECEX gas explosion protection	Ex db eb IIC Gb
ATEX gas certificate	FM 22 ATEX 0017 U
ATEX gas explosion protection	Ex II 2 G Ex db eb IIC Gb
FMus certificate	FM22US0011U
cFM certificate	FM22CA0006U
Marking FMus	Class I, Div. 2, Groups A,B,C,D; Class I, Zone 1, AEx db eb IIC Gb
Marking cFM	Class I, Zone 1, Ex db eb IIC Gb Class I, Div. 2, Groups A,B,C,D;
Certificates	ATEX (FM), Canada (FM), IECEX (FM), USA (FM)

Electrical Data

Rated operational voltage	max. 690 V
Rated operational current	80 A
Rated actuating voltage	20 to 33 V AC/DC
Mechanical service life	10,000,000
Idle operating frequency	5000 1/h
Operating frequency AC-3	500 1/h
Main contacts	3-pole (3 NO)
Auxiliary contacts	4 (2 NO + 2 NC)

Ambient Conditions

Ambient temperature	-25 °C ... +60 °C
---------------------	-------------------

Contactors

80 A

8550/1-CT-GLS3-80-95-U1S-22 Art. No. 287707

Ambient Conditions

Ambient temperature -13 °F ... +140 °F

Mechanical Data

Degree of protection (IP)	IP20
Enclosure material	Thermoplast
Connection cross-section	25 – 95 mm ²
Connection cross-section AWG	4 to 4/0 AWG
Auxiliary contact connection cross section	0.75 ... 2.5 mm ²
Auxiliary contact connection cross section AWG	18 ... 14 AWG
Width	150 mm
Width in inches	5.91 in
Height	196 mm
Height, inches	7.72 in
Depth	336.6 mm
Depth, inches	13.25 in
Weight	4.2 kg
Weight	9.26 lb

Mounting / Installation

Tightening torque	15 – 20 Nm
Tightening torque lbf in	132 to 177 lbf in
Tightening torque auxiliary contact	0.4 – 0.6 Nm
Tightening torque auxiliary contact lbf in	3.54 ... 5.31 lbf-in

Technical Drawings – Subject to Alterations

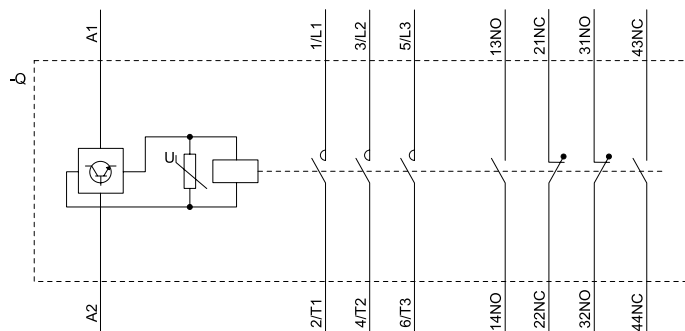

Circuit diagram of the device

Dimensional Drawings (All Dimensions in mm [inches]) – Subject to Alterations

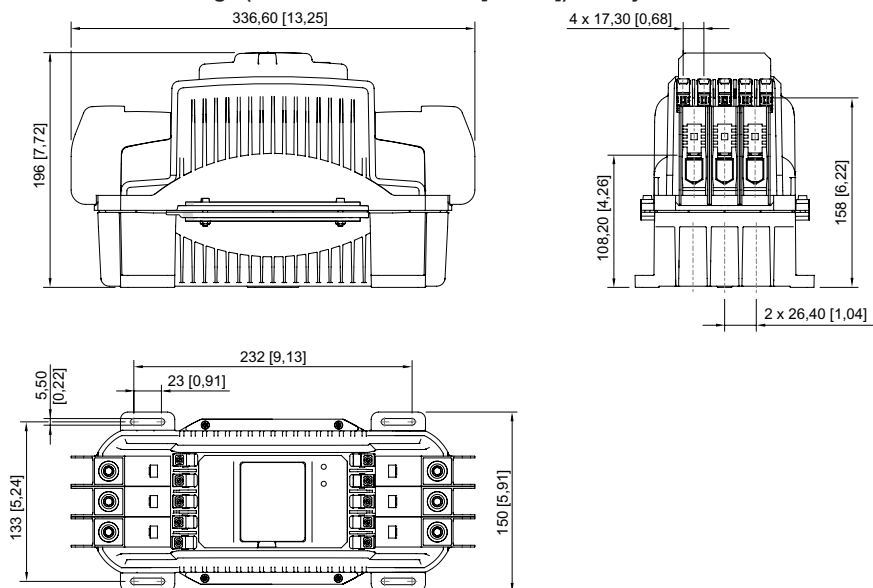

We reserve the right to make alterations to the technical data, dimensions, weights, designs and products available without notice. The illustrations cannot be considered binding.