

Lighting

Compact light fitting Emergency luminaire

With battery

6109/111-0101-160-0111-31-0850-001 Art. No. 287798



- Suitable for wall, ceiling and suspended mounting
- Operating modes: Continuous mode, continuous mode with switchable emergency lighting
- With function and rated operating time test with optional DALI technology
- Large recognition range $d \geq 30$ m
- Emergency exit signs with suspended panel so that they can be read from both sides
- Lightweight, robust and compact design

MY R. STAHL 6109A



C-LUX 6109 series compact emergency luminaires can be used for emergency lighting, as well as for indication or escape route luminaires.

Technical Data

Explosion Protection

Area of application	European Union (ATEX) IECEX
Ex version	Yes
Application range (zones)	1, 2, 21, 22
IECEX gas explosion protection	Ex db eb ib op is IIC T4 Gb
IECEX dust explosion protection	Ex tb op is IIIC T100 °C Db
ATEX gas explosion protection	⊕ II 2 G Ex db eb ib op is IIC T4 Gb
ATEX dust explosion protection	⊕ II 2 D Ex tb op is IIIC T100 °C Db
Certificates and approvals	ATEX IECEX UKEX
Certificates	ATEX (IBE), IECEX (IBE), Polen (CNBOP)
Declaration of conformity	ATEX (EUK)

Electrical Data

Frequency range	50 – 60 Hz
Battery version	NiCd battery, gas-tight
Battery operating voltage	6 V
Battery capacity	2.2 Ah
Self-test function	Function and battery duration test
LED service life	L90B50 \geq 100 h
AC operating voltage	100 ... 240 V
Control interface	without

Lighting Data

Lamp	LED
Light colour	Cool white
Light distribution	2 x 15° (without light attachment)
Luminaire efficacy	80 lm/W
Luminous flux	775 lm
Luminous flux	775 lm

Lighting

Compact light fitting Emergency luminaire

With battery

6109/111-0101-160-0111-31-0850-001 Art. No. 287798



Lighting Data

Operating time	1.5 / 3h emergency lighting operation
Emergency light output	25% – 3 h 50% – 1.5 h
Colour rendering	≥ 80
Colour temperature	5000 K
Colour temperature	5000 K

Ambient Conditions

Ambient temperature	-30°C ... +50°C Note: Through wiring Max. 3x16 A -30°C ... +60°C Note: Through wiring 2 Max. 3x10 A
---------------------	--

Mechanical Data

IP degree of protection (IEC 60598)	IP66 / IP67
Class	I
Enclosure material	Thermoset
Enclosure colour	Light grey (RAL 7035)
Cover material	Polycarbonate
Sealing material	Silicone
Silicone-free content	Without influence on paint wetting
Installed terminal strip	PE + N + L1 + L2 + L3 + L"
Max. solid connection terminals	6 mm ²
Max. finely stranded connection terminals	4 mm ²
Type of connection cable	Finely stranded Solid
Size	1
Width	185 mm
Height	90 mm
Length	440 mm
Impact strength (IEC 62262)	IK08
Disconnection of the luminaire	No
Weight	3.3 kg
Weight	7.28 lb

Components

Variant	Without diffuser 15°
Threaded plate	Plastic
Ballast	6046/311-841-060 NLE standard
Through wiring	Loop in/loop out
Drilled holes	3 x M25
Cable glands and entries	2 x M25 Ø 7 ... 17 mm
Stopping plugs	2 x M25 x 1.5
Stopping plug material	Polyamide, black
Breather	without
Accessories	Provided

Lighting

Compact light fitting Emergency luminaire

With battery

6109/111-0101-160-0111-31-0850-001 Art. No. 287798



Dimensional Drawings (All Dimensions in mm [inches]) – Subject to Alterations

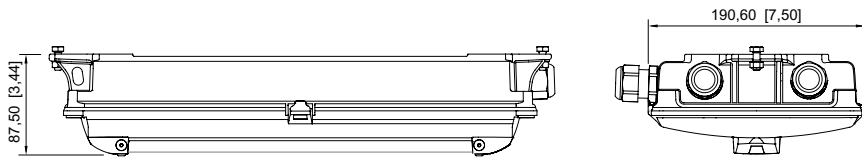
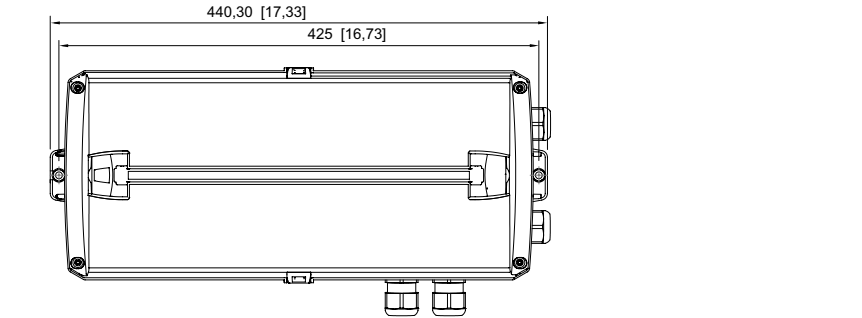

without escape sign

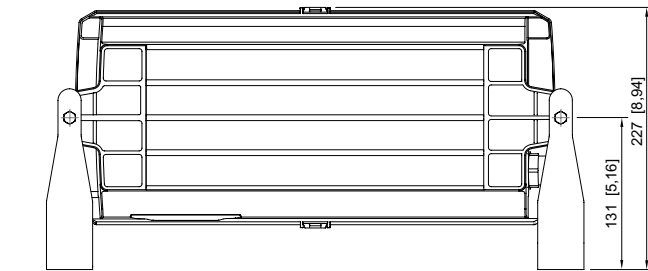
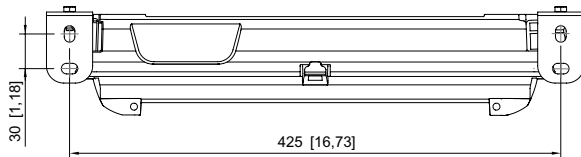

with mounting brackets

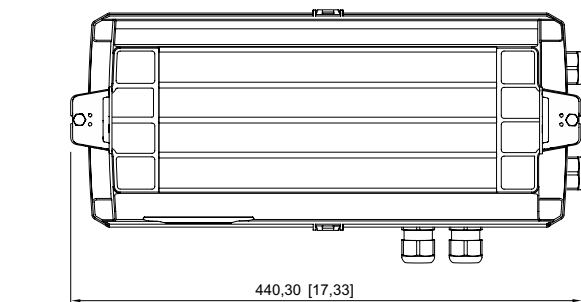
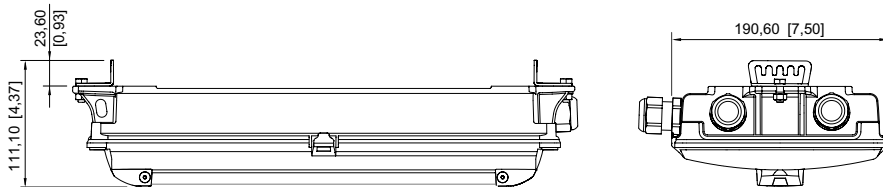

for rope/chain mounting

Lighting

Compact light fitting Emergency luminaire

With battery

6109/111-0101-160-0111-31-0850-001 Art. No. 287798



Accessories



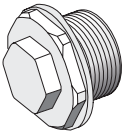
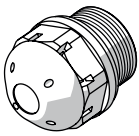

Breather

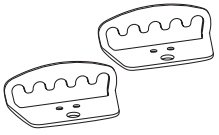
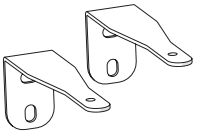
		Art. No.
	Thread: M20 x 1.5 (1 piece); for installation in light fittings; made from stainless steel; without jam nut	323702
	Thread: M25 x 1.5 (1 piece); for installation in light fittings; made from stainless steel; without jam nut	296608
	M25 x 1.5 in order to avoid condensate formation	115738

Fastening set

		Art. No.
	for chain/rope assembly	275407
	for wall mounting	275408

Light panel

		Art. No.
	Escape route double sided	275872
	Escape route, down	274776
	Escape route, up	274758
	Escape route, down double-sided	274780
	Escape route, up double-sided	274772
	Escape route, left	274757
	Escape route, right	274775

Lighting

Compact light fitting Emergency luminaire



With battery

6109/111-0101-160-0111-31-0850-001 Art. No. 287798

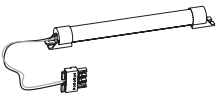

Light panel		Art. No.
	Escape route left/right double-sided	274773
	Escape route stairs, down left	274777
	Escape route stairs, down right	274778
	Escape route stairs, down double-sided	274779
	Escape route stairs, up left	274759
	Escape route stairs, up right	274760
	Escape route stairs, up double-sided	274771
	EXIT	275514

Spare Parts

Battery set		Art. No.
	NiCd battery, gas-tight; 2.2 Ah / 6 V	273190
Optic		Art. No.
	Diffuser	274756
Diffusing lens		Art. No.
	Deflection optics	274781

We reserve the right to make alterations to the technical data, dimensions, weights, designs and products available without notice. The illustrations cannot be considered binding.