

6057/2114-101-4330-121-200 Art. No. 288956



- Aesthetically appealing pendant light fitting with 4 wattage ranges.
- Ideal for use in Zone 1 & Zone 21 with EX d protection
- Made of copper-free aluminium for absolute corrosion resistance.
- World-class quality standards: Certified and approved by PESO.
- Tough and durable: Can withstand impacts of up to 20 J and complies with IK10.
- Suitable for wide range of ambient temperatures from -20 °C to +50 °C.
- Longer luminaire service life with a promise of over 50,000 operating hours.
- All-round safety: Driver with under- and overvoltage protection and overtemperature protection.
- More lumens per watt with superior light output.

WebCode 6057A

The 6057 pendant light fitting is intended for lighting areas, work equipment and objects. It can be used indoors and outdoors. Using the right accessories, these light fittings can be used as pendant light fittings or, alternatively, they can be wall-mounted, ceiling-mounted or pole-mounted. With two thermally separated enclosure parts for the driver unit and LED unit, the 6057 pendant light fitting is a fail-safe luminaire meant for the harshest environments.

Technical Data

Explosion Protection

Application range (zones)	1 2 21 22
PESO gas certificate	KLPL/Ex/21-032X
PESO gas explosion protection	Ex db IIC T6 Gb
Certificates and approvals	India (PESO)

Electrical Data

AC max. rated operational voltage	240 V
AC min. rated operational voltage	220 V
Power factor	≥ 0.96
Frequency range	50 – 60 Hz
Start-up current	$I_{peak} \leq 16 \text{ A}$, $\Delta t = 100 \mu\text{s}$
Surge protection	4KV

Input

Surge protection	4KV
------------------	-----

Lighting Data

Number of lamps	1
Lamp wattage	45 W
Lamp type	LED
Lamp	LED
Light colour	5700 K – cool white
Light distribution	Wide beam

6057/2114-101-4330-121-200 Art. No. 288956

Lighting Data

Luminaire efficacy	104 lm/W
Luminous flux	4661 lm
Colour rendering	≥ 80
Colour temperature	5700 K

Ambient Conditions

Ambient temperature	-20 °C ... +50 °C
Storage temperature	-20 °C ... +60 °C

Mechanical Data

Version	Pendant light fitting
Degree of protection (IP)	IP66 / IP67
Enclosure material	Aluminium, Powder-coated
Enclosure colour	Light grey (RAL 7035)
Sealing material	Silicone
Silicone-free content	Contains silicone
Protective glass material 2	Borosilicate glass
Max. solid connection terminals	4 mm ²
Max. finely stranded connection terminals	4 mm ²
Type of connection cable	Finely stranded Finely stranded with clip Solid
Size	2
Width	184 mm
Height	344 mm
Length	234 mm
Impact strength (IEC 62262)	IK10
Fastening	without mounting accessories
Reflector	Yes
Weight	5 kg
Weight	11.02 lb
Disconnection of the luminaire	No

Components

Through wiring	Max. 3 x 10 A
Drilled holes	2 x NPT 1/2
Cable glands and entries	According to the order
Stopping plugs	According to the order
Wire guard	No

6057/2114-101-4330-121-200 Art. No. 288956

Light Distribution Curves

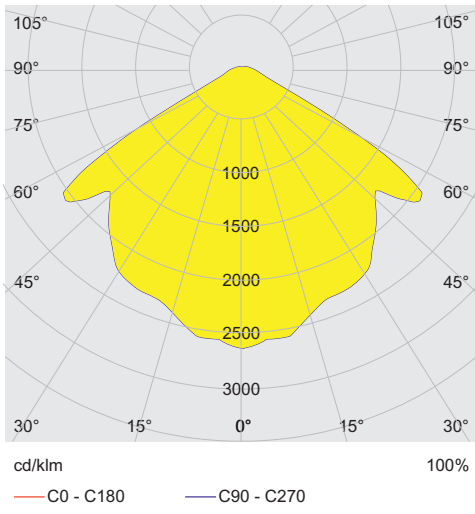

Light Distribution Curve 6057

Dimensional Drawings (All Dimensions in mm [inches]) – Subject to Alterations

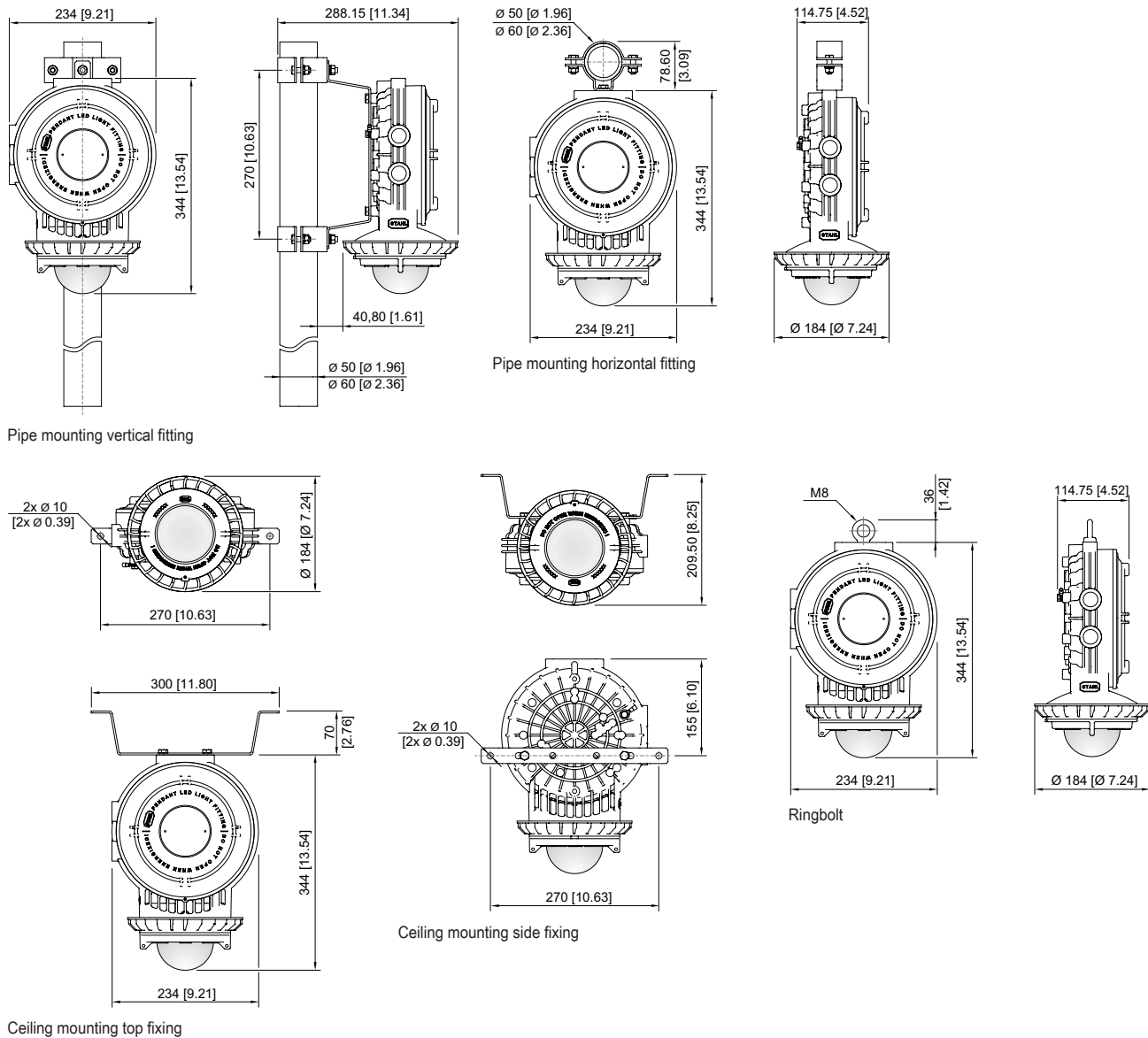

6057/2114-101-4330-121-200 Art. No. 288956

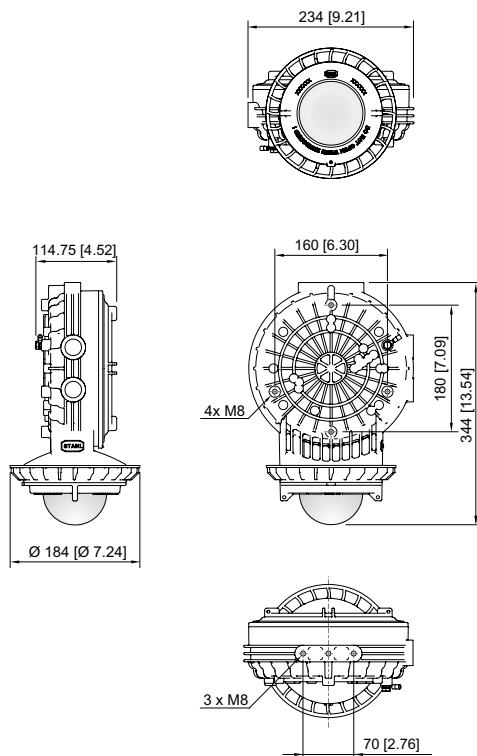

Standard

Accessories

Mounting bracket

		Art. No.
	Horiz. Pipe mtg. brk. Ø50mm 6057 spare	289889
	Horiz. Pipe mtg. brk. Ø60mm 6057 spare	290041
	Verti. Pipe mtg. brk. Ø50mm 6057 spare	289890
	Verti. Pipe mtg. brk. Ø60mm 6057 spare	290042
	Wall/ceiling mtg.brk. 6057 spare 1.4301	288823

Ring bolt

		Art. No.
	Ring bolt M8x9 similar DIN 580 C15	115896

We reserve the right to make alterations to the technical data, dimensions, weights, designs and products available without notice. The illustrations cannot be considered binding.