

EC-940S-AFZ-HGI-W2F-55B Art. No. 290557



- Certified for hazardous Zones 1, 2, 21, 22 acc. to ATEX, IECEx, NEC, CEC
- Super-Low-Light-Technology for extremely detailed images, even in difficult lighting conditions, day / night - functionality
- IP Camera with Full HD for optimum image quality
- Enclosure electropolished and Silicon micro-blasted
- Delivery with cable set (NEC / CEC)
- Digital image stabilization, dynamic masking

MY R. STAHL EC940SAFZIB



ONVIF



R. STAHL's EC-940S-AFZ zoom cameras are all-round talents for surveillance in hazardous areas because in addition to an excellent panoramic view they also produce very good detailed images. This is the result of the IP camera's high resolution (Full HD with 1920 x 1080), the optical 30x zoom and the brilliant image quality - the WDR function (120 dB) optimises the lighting of very bright or dark areas even in difficult lighting conditions. The built-in wiper and the defog function also ensure a clear view. The IP models are amongst the most modern cameras for hazardous areas and can be integrated into VMS systems worldwide via the ONVIF protocol (Profile Q, S and T).

Technical Data

Explosion Protection

Application range (zones)	1 2 21 22
Certifications	ATEX, IECEx, NEC®, CE Code
IECEx gas certificate	ITS 16.0026X
IECEx gas explosion protection	Ex db IIC T5 Gb
IECEx dust certificate	ITS 16.0026X
IECEx dust explosion protection	Ex tb IIIC 100 °C Db IP66, 67, 68, 69
ATEX gas certificate	16 ATEX 18446X
ATEX gas explosion protection	⊕ II 2 G Ex db IIC T5 Gb
ATEX dust certificate	16 ATEX 18446X
ATEX dust explosion protection	⊕ II 2 D Ex tb IIIC 100 °C Db IP66, 67, 68, 69
NEC 505 dust explosion protection	Zone 21 AEx tb IIIC T100°C Db
Gas explosion protection CEC	Ex db IIC T5 Gb
Dust explosion protection CEC	Ex tb IIIC T100°C Db
Lloyd's Register categories	ENV1, ENV2, ENV3, ENV5

Electrical Data

Rated operational voltage AC	24 V
Rated operational voltage DC	12 ... 24 V
Rated operational current AC	2.2 A
Rated operational current for DC	2.2 – 3.5 A
Interfaces	RJ45 socket
Connection	Ethernet LAN 100Base-TX, RJ45

EC-940S-AFZ-HGI-W2F-55B Art. No. 290557

Electrical Data

I/O alarm	1x alarm input
I/O relay	1x relay output

Camera Data

Sensor	1/2.8" Exmor R CMOS
Lens	f = 4.3 (w) to 129 mm (t) From F1.6 to F14
Viewing angle	63.7° to 2.3° H, 38.5° to 1.3° V
Focus	Auto, manual, trigger
Zoom	30x (360x digital zoom)
Resolution	Full HD 1080p 1920x1080 pixels
Pixel	2.13 megapixels
Minimum illumination B/W (ICR-ON)	0.0008 lx, 30 IRE
Minimum illumination color (ICR-OFF)	0.0013 lx 50 IRE
Number of streams	3 independent video streams Full HD Depending on configuration
Frame rate (fps)	1 to 60 frames per second
Back light compensation	On/Off
Electronic shutter	1/1 to 1/10,000s
Compression	H.264, MJPEG, JPEG, MPEG4
No. of privacy maskings	24 (8 simultaneously)
De-fog	Off/Low/Mid/High
WDR (dynamic range)	120 dB
White balance	AWB, ATW, internal, external (Fixed, auto), sodium vapour lamp (Fixed, auto, external auto)
Wide Dynamik Range	On/Off Light level, selection of Brightness compensation Light compensation level
Motion detection	Yes
Web server	Yes

Software

Network protocol	ONVIF profiles Q,S,T
Network Configuration	TCP/IPv4-IPv6, UDP/IPv4-IP6, HTTP, HTTPS, NTP, DHCP, WS-DISCOVERY, DSCP, IGMP (Multicast), SOAP, DNS, SNMP
Streaming	RTSP, RTCP, RTP/IPv4, HTTP Multicast

Ambient Conditions

Ambient temperature	-50 °C ... +65 °C
Cold start range (with heating)	-40°C up to -10°C

Mechanical Data

Version	Low-light technology
Degree of protection (IP)	IP66, 67, 68, 69
Enclosure material	Stainless steel 1.4404
Surface treatment	Shotblasted + electropolished
Cable structure	Unarmoured cable set
Cable length	4 m
Opening for cable gland	1 3/4" NPT with cable gland
Integrated wiper	Yes
Feature	Advanced image stabilisation
Package weight	12.5 kg
Package dimensions	600 x 300 x 600 mm

EC-940S-AFZ-HGI-W2F-55B Art. No. 290557



Mechanical Data

Weight	8.5 kg
Weight	18.74 lb

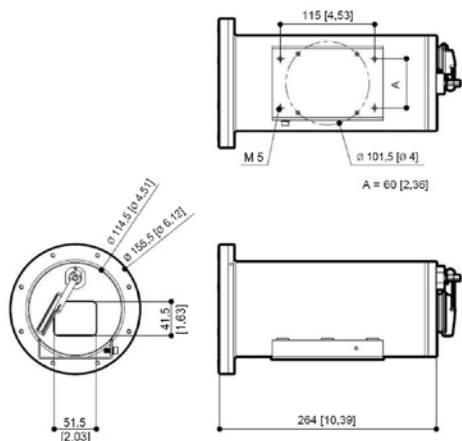



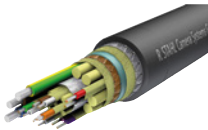

Dimensional Drawings (All Dimensions in mm [inches]) – Subject to Alterations



Accessories

Camera multi-cable armoured		Art. No.
	<p>VB-CAM-MULTI-Ethernet-ARM 1 x Ethernet cable 3 x power supplies 2.5 mm² 7 x data cable 0.34 mm² -60 °C ... +80 °C 19.2 ±0.5 mm outer diameter IEC 60332-1 flame-resistant IEC 60754-2 halogen-free DIN 60811-404 oil-resistant NEK 606 mud-resistant Price and weight per m</p>	252571
Ex e Terminal box		Art. No.
	<p>JCT-8146-Ethernet+Analog 5xcable glands Terminal box, polyester resin Version for ethernet Tx or analog cameras Dimensions without cable glands (HxWxD): 340.5 mm x 340.5 mm x 91 mm Ingress protection: IP66 equipped with: 5 x cable glands: 2 x CMP-25SC2KVAR KLE MsNi M25x1.5 1 x 8161/7-M25-1707 with red stopping plug 2 x 8161/7-M20-1304 with red stopping plug usable for: EC-750, EC-910-AFZ, EC-940S-AFZ (ATEX, IECEx) EC-840S-TIC (ATEX, IECEx), EC-94x-PTZ, Water tank</p>	265668

EC-940S-AFZ-HGI-W2F-55B Art. No. 290557

Wall bracket		Art. No.
	<p>WB-EC-840S/EC-940S Suitable for EC-x40S series Material: 316L stainless steel, electropolished Capacity: max. 40 kg Length: 420 mm</p>	251387
Pole adapter module		Art. No.
	<p>PMA-EC-840S /EC-940S Suitable for EC-x40S For pole diameter 110 ... 150 mm Material: 316L stainless steel, electropolished Capacity: max. 50 kg Weight: 3.3 kg Only together with wall bracket EC-x40S type 251387</p>	251380
Corner adapter module		Art. No.
	<p>CMA-EC-840S /EC-940S Suitable for EC-x40S series Material: 316L stainless steel, electropolished Capacity: max. 50 kg Only together with wall bracket EC-x40S type 251387</p>	251381
Parapet mounting bracket		Art. No.
	<p>PM-EC-840S /EC-940S Suitable for EC-x40S series Material: 316L stainless steel, electropolished Capacity: max. 70 kg Height: 124 mm Only together with ball joint adapter EC-x40S type 251388</p>	251386
Ball joint		Art. No.
	<p>MPT-Head-EC-840S/EC-940S 316L stainless steel, electropolished Capacity: max. 40 kg Diameter: 101.6 mm</p>	251388
Water tank		Art. No.
	<p>WaterTank 10-PV-A 316L (1.4404) stainless-steel enclosure, electropolished Capacity 10 litres Pressure generation by manual pumping or with compressed air Pressure: max 6 bar 24 V AC/DC, max 20 W Temp. range -40 °C to +60 °C (depending on freezing point of liquid used) ATEX certified Zone 1, 2 Suitable for EC-94x-PTZ and EC-940S-AFZ</p>	251366

We reserve the right to make alterations to the technical data, dimensions, weights, designs and products available without notice. The illustrations cannot be considered binding.