

6525/2224-5501-6025-331 Art. No. 291165



- Checked and approved in accordance with Ex ec type of protection, so vapour tightness test is not applicable
- Stainless steel enclosure as standard for a long service life and safety even under harsh ambient conditions
- Extremely wide range of ambient temperatures – between -60 °C and +60 °C
- Robust design with IK10 and IP66
- Wide-range input with optional 100 V to 277 V
- DALI versions available for lighting control, monitoring and switching

WebCode 6525C



The revised generation of LED floodlights for Zone 2 now includes a version with Ex ec type of protection especially for the European market. This eliminates the time-consuming vapour tightness test. The wide-range input now also meets the electrical installation conditions for global use. With an optional DALI interface, the floodlight paves the way to a digital lighting solution. Its extremely low start-up current can also support existing installations, as the circuit breakers that are already installed do not need to be replaced.

Technical Data

Explosion Protection

Application range (zones)	2 21 22
IECEX gas certificate	IECEX EPS 15.0032
IECEX gas explosion protection	Ex db ec IIC T4 Gc
IECEX dust certificate	IECEX EPS 15.0032
IECEX dust explosion protection	Ex tb op is IIIC T100 °C Db
ATEX gas certificate	EPS 15 ATEX 1 991
ATEX gas explosion protection	Ex II 3 G Ex db ec IIC T4 Gc
ATEX dust certificate	EPS 15 ATEX 1 991
ATEX dust explosion protection	Ex II 2 D Ex tb op is IIIC T100 °C Db
Certificates	ATEX (BVIS), IECEX (BVIS), India (PESO)

Electrical Data

Rated operational voltage AC	110 – 277 V
AC max. rated operational voltage	277 V
AC min. rated operational voltage	110 V
Frequency range	50 – 60 Hz

Lighting Data

Lamp wattage	225 W
Lamp type	LED
Lamp	LED
Light colour	Neutral white
Light distribution	Wide beam
Luminaire efficacy	95 lm/W
Luminous flux	20909 lm

6525/2224-5501-6025-331 Art. No. 291165

Lighting Data

Colour rendering	≥ 80
Colour temperature	5000 K

Ambient Conditions

Ambient temperature	-60 °C ... +60 °C
Storage temperature	-40 °C ... +75 °C

Mechanical Data

Degree of protection (IP)	IP66
Class	I
Enclosure material	Stainless steel 1.4301, Powder-coated Single-layer powder-coated
Enclosure colour	Similar to RAL 9010
Sealing material	Silicone
Pane material	Reinforced glass
Max. solid connection terminals	6 mm ²
Max. finely stranded connection terminals	4 mm ²
Type of connection cable	Finely stranded Solid
Width	400 mm
Height	84 mm
Length	520 mm
Impact strength (IEC 62262)	IK10
Fastening	With bracket, SS304
Weight	18.5 kg
Weight	40.79 lb

Components

Drilled holes	3 x M20
Cable glands and entries	1 x M20 x 1.5 CMP-20A2F
Material cable gland	Nickel-plated brass
Stopping plugs	2 x M20 x 1.5
Stopping plug material	Polyamide, black

6525/2224-5501-6025-331 Art. No. 291165

Light Distribution Curves

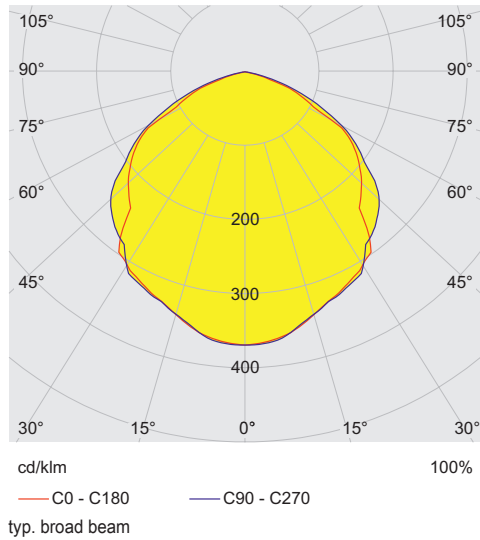

Dimensional Drawings (All Dimensions in mm [inches]) – Subject to Alterations

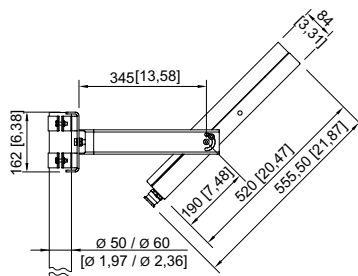
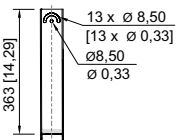
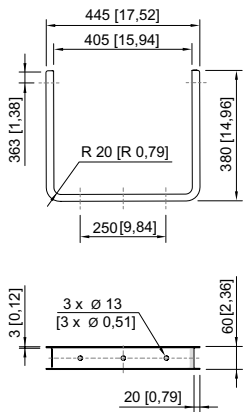

Floodlight with pole mounting

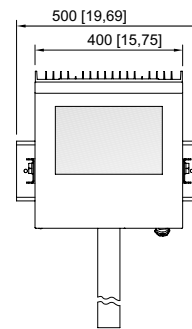

Mounting bracket

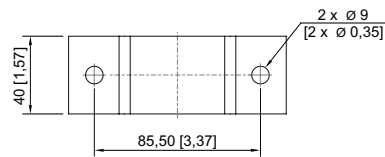
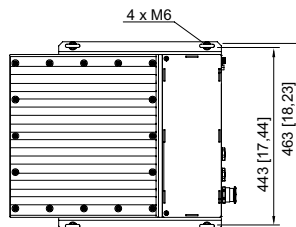
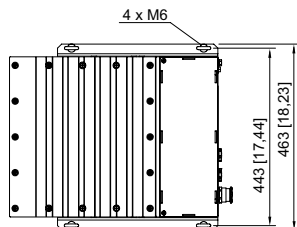
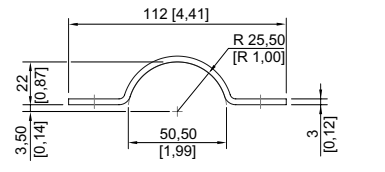
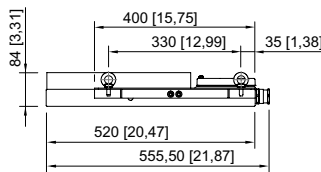
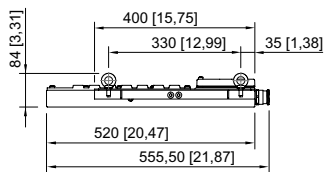

6525/2224-5501-6025-331 Art. No. 291165

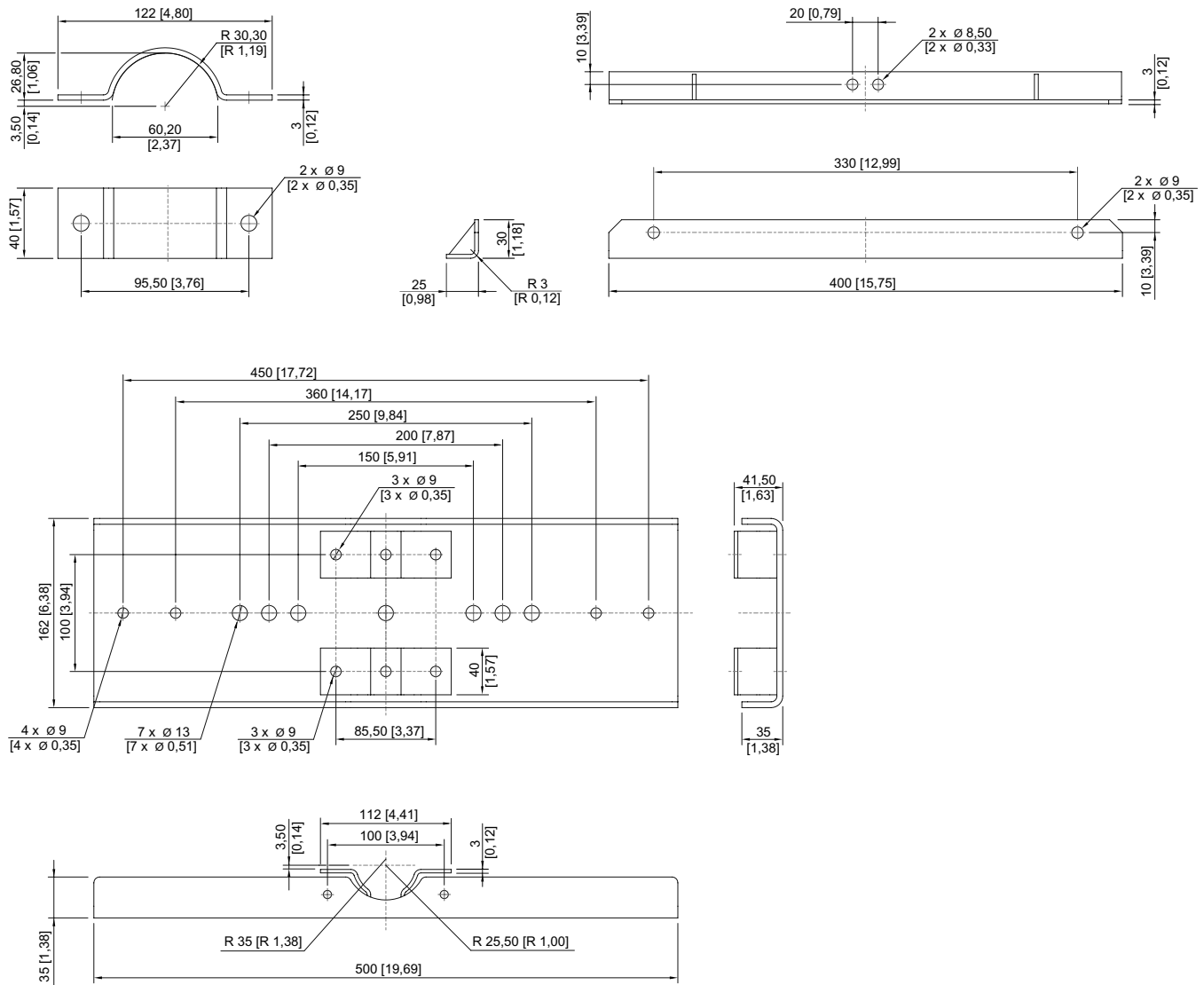

6525/2224-5501-6025-331 Art. No. 291165

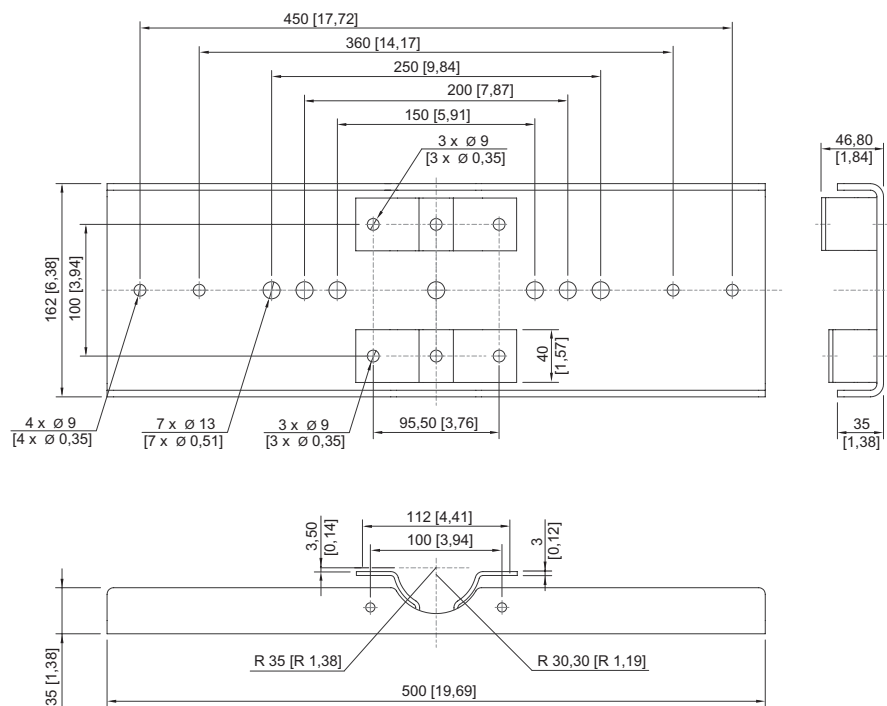

Accessories

Mounting bracket



Stainless steel SS304 (1.4301 or V2A) without powder coating

Art. No.

269731

Stainless steel SS316L (1.4404 or V4A) without powder coating

221589

Mounting set

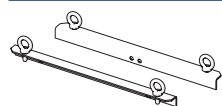

for pendant mounting with ring bolts included - stainless steel SS316L (1.4404 or V4A) without powder coating

Art. No.

257464

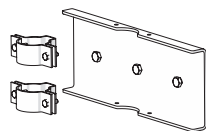

for pole mounting with pole diameter of 50 mm - stainless steel SS316L (1.4404 or V4A) without powder coating

283361

for pole mounting with pole diameter of 60 mm - stainless steel SS316L (1.4404 or V4A) without powder coating

263824

We reserve the right to make alterations to the technical data, dimensions, weights, designs and products available without notice. The illustrations cannot be considered binding.