

8166/11-06-NE Art. No. 139087



- Hazardous location conduit hubs "increased safety"
- Wide range of NPT thread sizes
- Large temperature range of use
- Globally marked, IECEx, ATEX and cULus
- Integrated self-loosening protection through threaded pin

MY R. STAHL 8166A



R. STAHL's 8166 series conduit hubs are used to insert permanently installed conduit systems with NPT threads into electrical equipment with type of protection Increased Safety "e" or Protection by Enclosure "tb" and suitable for NEMA type 4X installation.

Technical Data

Explosion Protection

Scope of validity	USA Canada European Union (ATEX) IECEX
Application range (zones)	1 2 21 22
IECEX gas certificate	IECEX PTB 06.0095 U
IECEX gas explosion protection	Ex eb IIC Gb
IECEX dust certificate	IECEX PTB 06.0095 U
IECEX dust explosion protection	Ex tb IIIC Db
ATEX gas certificate	PTB 00 ATEX 1114 U
ATEX gas explosion protection	⊕ II 2 G Ex eb IIC Gb
ATEX dust certificate	PTB 00 ATEX 1114 U
ATEX dust explosion protection	⊕ II 2 D Ex tb IIIC Db
Certificate ULus	E200949V1S2
Certificate cUL	E200949V1S2
Marking ULus	Class I, Zone 1 AEx e II Class I, Div. 2, Groups A,B,C,D Class II, Div. 2, Groups F,G Class III Type 3, 4, 4X
Marking cUL	Class I, Zone 1 Ex e II Class I, Div. 2, Groups A,B,C,D Class II, Div. 2, Groups F,G Class III Type 3, 4, 4X
Certificates	ATEX (PTB), Canada / USA (UL), Canada (UL), IECEX (PTB)

8166/11-06-NE Art. No. 139087

Electrical Data

PE-pole present Yes

Ambient Conditions

Ambient temperature -30 °C ... +100 °C

Ambient temperature -22 °F ... +212 °F

Mechanical Data

Version NPT / NPT

Degree of protection (IP) IP66

Degree of protection (IP) (IEC 60529) IP66

Degree of protection (NEMA) 3, 4, 4X

Material Zinc

Silicone-free No

Outer diameter 83.57 mm

Outer diameter in inches 3.298 in

External thread NPT2

Thread size NPT2

Internal thread NPT2

Weight 270 g

Weight 0.6 lb

Dimensional Drawings (All Dimensions in mm [inches]) – Subject to Alterations

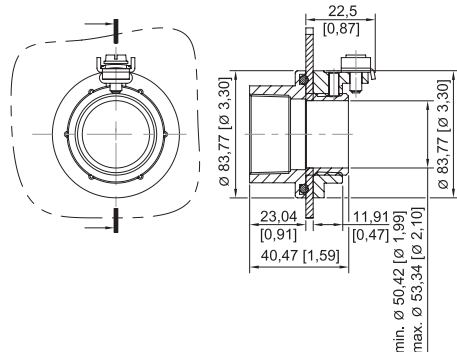

8166/11-06-NE

We reserve the right to make alterations to the technical data, dimensions, weights, designs and products available without notice. The illustrations cannot be considered binding.