

Load disconnect switches and motor starters

Direct-on-line mtr strtr (DOL)



8220/5-SM-ES30kW400V-T Art. No. 142439



- Modular motor control units for all gas groups
- Control units: Direct-on-line motor starters (DOL), YD star-delta contactor combinations, reversing contactor combinations
- As an option, they can be equipped with main switches, main fuses, and control and signalling devices depending on the customer's specific requirements

MY R. STAHL 8220A



R. STAHL Series 8220 standard motor control units are installed in Ex d enclosures and have an Ex e connection chamber enclosure. They are available in various control versions for rapid delivery. As an option, the control units can be fitted with main switches, main fuses, and control and signalling devices as per the customer's requirements.

Technical Data

Explosion Protection

Application range (zones)	1, 2, 21, 22
IECEX gas certificate	IECEX PTB 06.0069
IECEX gas explosion protection	Ex db eb IIC T6 Gb
IECEX dust certificate	IECEX PTB 06.0069
IECEX dust explosion protection	Ex tb IIIC T80 °C Db
ATEX gas certificate	PTB 02 ATEX 1109
ATEX gas explosion protection	Ex II 2 G Ex db eb IIC T6 Gb
ATEX dust certificate	PTB 02 ATEX 1109
ATEX dust explosion protection	Ex II 2 D Ex tb IIIC T80 °C Db
Declaration of conformity	ATEX (EUK), China (CCC)

Electrical Data

AC rated operational voltage	400 V
Switching capacity	30 kW

Ambient Conditions

Ambient temperature	-20 °C ... +40 °C
---------------------	-------------------

Mechanical Data

Degree of protection (IP)	IP54
Degree of protection (IP) (IEC 60529)	IP65
Enclosure material	Sheet steel, painted
Enclosure colour	Light grey (RAL 7035)
Dimensions (W x H x D)	360,000 x 360,000 x 268,000 mm
Dimensions (W x H x D) inches	360,000 x 360,000 x 268,000 mm
Width	360 mm
Height	360 mm
Depth	268 mm
Weight	76 kg

Load disconnect switches and motor starters

Direct-on-line mtr strtr (DOL)



8220/5-SM-ES30kW400V-T Art. No. 142439

Technical Drawings – Subject to Alterations

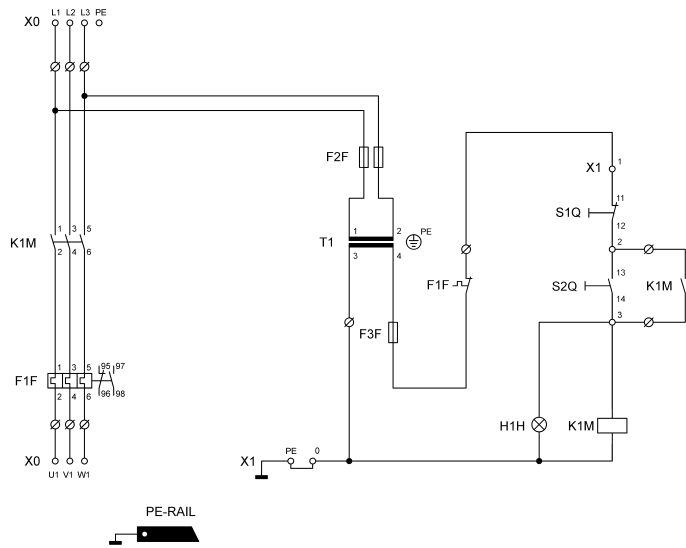

Dimensional Drawings (All Dimensions in mm [inches]) – Subject to Alterations

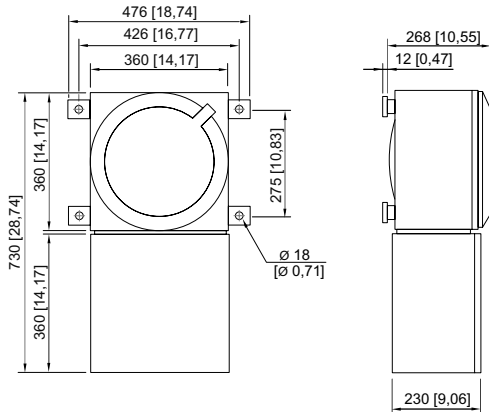

8220/122

We reserve the right to make alterations to the technical data, dimensions, weights, designs and products available without notice. The illustrations cannot be considered binding.