

# Load Disconnect Switches and Motor Starters

## YD star-delta contactor combination



8220/5-SL-SS37kW400V-T Art. No. 142449



- Modular motor starters for all gas groups
- Control panels: Direct-On-Line Motor Starter DOL, YD, reversing contactor combinations
- Optional customer-specific equipping with main switches, main fuses and control devices

MY R. STAHL 8220A



R. STAHL Series 8220 standard motor starters are installed in Ex d enclosures and have an Ex e connection chamber enclosure. They are available in various control variants for rapid delivery. As an option, the control panels can be fitted with main switches, main fuses and control devices as per the customer's requirements.

### Technical Data

#### Explosion Protection

Application range (zones)	1 2 21 22
IECEX gas certificate	IECEX PTB 06.0069
IECEX gas explosion protection	Ex db eb IIC T6 Gb
IECEX dust certificate	IECEX PTB 06.0069
IECEX dust explosion protection	Ex tb IIIC T80 °C Db
ATEX gas certificate	PTB 02 ATEX 1109
ATEX gas explosion protection	Ex II 2 G Ex db eb IIC T6 Gb
ATEX dust certificate	PTB 02 ATEX 1109
ATEX dust explosion protection	Ex II 2 D Ex tb IIIC T80 °C Db
Declaration of Conformity	ATEX (EUK), China (CCC)

#### Electrical Data

Rated operational voltage AC	400 V
------------------------------	-------

#### Ambient Conditions

Ambient temperature	-20 °C ... +40 °C
---------------------	-------------------

#### Mechanical Data

Degree of protection (IP)	IP54
Degree of protection (IP) (IEC 60529)	IP65
Enclosure material	Sheet steel, painted
Enclosure colour	Light grey (RAL 7035)
Dimensions (W x H x D)	360,000 x 480,000 x 268,000 mm
Width	360 mm
Height	480 mm
Depth	268 mm
Weight	96 kg

# Load Disconnect Switches and Motor Starters

## YD star-delta contactor combination



8220/5-SL-SS37kW400V-T Art. No. 142449

### Mechanical Data

Weight	211.64 lb
--------	-----------

### Technical Drawings – Subject to Alterations

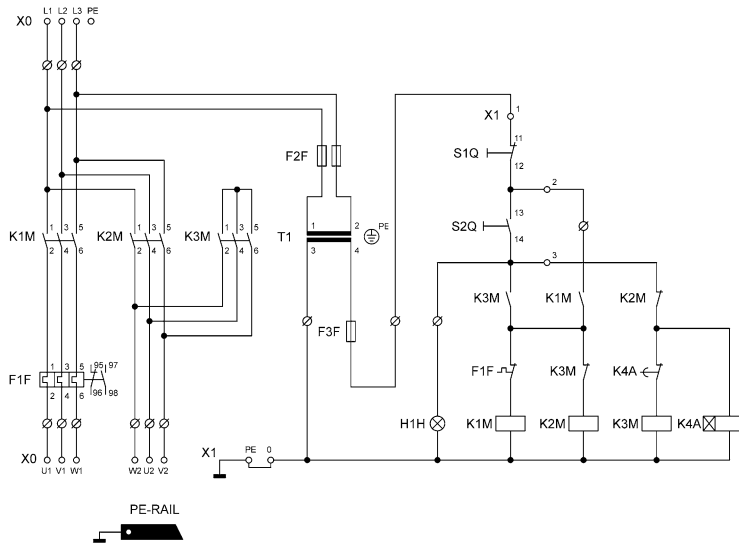

### Dimensional Drawings (All Dimensions in mm [inches]) – Subject to Alterations

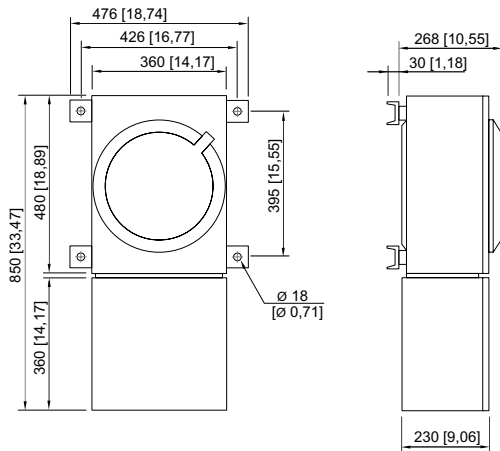

8220/172

We reserve the right to make alterations to the technical data, dimensions, weights, designs and products available without notice. The illustrations cannot be considered binding.