

8265/06-0000 Art. No. 143413



- Six basic enclosure sizes, optional inspection windows, direct and indirect cable entry possible
- International certification, wide temperature range, seawater-resistant light-metal enclosure
- Suitable series 8146/8150 connection-chamber enclosures possible

MY R. STAHL 8265A



R. STAHL series 8265 Ex d enclosures are ideal for motor control units, control boxes and terminal boxes. We equip these with various components, including sparking equipment, according to customer requirements. The cable entry can be direct or indirect. The large cover opening makes commissioning and maintenance easier. Single enclosures are ideal as components in Ex e control systems. Optional, large inspection window possible.

Technical Data

Explosion Protection

Application range (zones)	1 2 21 22
IECEX gas certificate	IECEX PTB 07.0027 U
IECEX gas explosion protection	Ex db eb IIC Gb
IECEX dust certificate	IECEX PTB 07.0027 U
IECEX dust explosion protection	Ex tb IIIC Db
ATEX gas certificate	PTB 06 ATEX 1023 U
ATEX gas explosion protection	Ex II 2 G Ex db eb IIC Gb
ATEX dust certificate	PTB 06 ATEX 1023 U
ATEX dust explosion protection	Ex II 2 D Ex tb IIIC Db
Marking cULus	Class I, Div. 1, Groups A, B, C & D Class I, Zone 1, Group IIC Class II, Div. 1, Groups E, F & G Class III
Certificates	ATEX (PTB), Brazil (ULB), China (NEPSI), IECEX (PTB), Taiwan (ITRI)
Ship approval	DNV
Declaration of Conformity	Certificate of conformity (ATEX)

Ambient Conditions

Ambient temperature	-50 °C ... +60 °C
Ambient temperature	-58 °F ... +140 °F

Mechanical Data

Degree of protection (IP)	IP54
Note on degree of protection	IP66 with O-ring silicone -60 °C ... +60 °C
Enclosure material	Aluminium, copper-free, Seawater-resistant
Enclosure colour	without

8265/06-0000 Art. No. 143413

Mechanical Data

Material note	Where there will be direct contact with seawater, a coating is recommended.
Clamping range max.	120 mm ²
Cover	Closed
Design	Without entry
Width	335 mm
Width in inches	13.19 in
Height	281 mm
Height, inches	11.06 in
Length	335 mm
Length, inches	13.19 in
Diameter	410 mm
Enclosure size	6
Weight	27.8 kg
Weight	61.29 lb

Dimensional Drawings (All Dimensions in mm [inches]) – Subject to Alterations

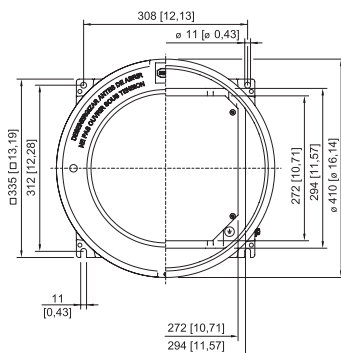
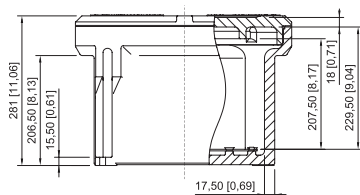

Enclosure size 6 without inspection window

Accessories

Cover without sight glass

	Enclosure: 8265/.6-0000	Art. No. 143476
--	-------------------------	---------------------------

Mounting rail

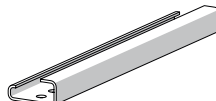
	G32 length: 280 mm [11.02 in] for enclosure size 6	Art. No. 166450
--	---	---------------------------

8265/06-0000 Art. No. 143413

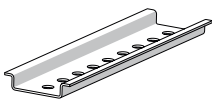
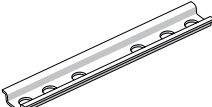
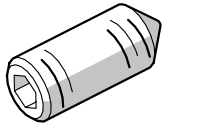
	TS35 length: 280 mm [11.02 in] for enclosure size 6	166449
	TS15 length: 280 mm [11.02 in] for enclosure size 6	166448
Threaded pin		Art. No.
	M5x16-A2 with allen screw and point	110216

Spare Parts

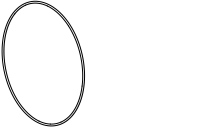
Mounting plate		Art. No.
	for enclosure size 6 M5 x 8 screws are not included.	143488
O-ring		Art. No.
	silicone, for enclosure size 6	305633

We reserve the right to make alterations to the technical data, dimensions, weights, designs and products available without notice. The illustrations cannot be considered binding.