



- Modular component for residual current monitoring
- Can be used for pulsating direct currents and alternating currents
- Protection against contact voltages

MY R. STAHL 8562A



The R. STAHL Series 8562 residual current circuit breaker is a component for residual current monitoring and switches systems in the event of residual currents – for reliable protection of persons in hazardous areas. It is suitable for pulsating direct currents and alternating currents and is designed for rated operational currents of 16, 25 or 40 A and rated residual currents of 10, 30, 100, 300 and 500 mA.

Technical Data

Explosion Protection

Application range (zones)	1 2
IECEX gas certificate	IECEX PTB 06.0062U
IECEX gas explosion protection	Ex de IIC T6 Gb
IECEX firedamp certificate	IECEX PTB 06.0062U
IECEX firedamp protection	Ex de I Mb
ATEX gas certificate	PTB 02 ATEX 1049 U
ATEX gas explosion protection	Ex II 2 G Ex de IIC T6 Gb
ATEX firedamp certificate	PTB 02 ATEX 1049 U
ATEX firedamp protection	Ex I M2 Ex de I Mb
FMus certificate	3033692
cFM certificate	3033692C
cCSA certificate	1850696
Certificates	ATEX (PTB), Brazil (ULB), China (CQST), IECEX (PTB)

Electrical Data

Type of voltage	AC
Rated residual current	0.03 A
N-pole present	Yes
No. of poles	4

Ambient Conditions

Ambient temperature	-20 °C ... +60 °C
---------------------	-------------------

Mechanical Data

Degree of protection (IP)	IP20
Enclosure material	Epoxy resin
Length	156 mm
Depth of cut-out	97.5 mm

Mechanical Data

Weight	1.8 kg
Weight	3.97 lb

Technical Drawings – Subject to Alterations

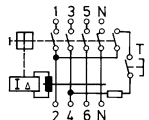

4 pole

Dimensional Drawings (All Dimensions in mm [inches]) – Subject to Alterations

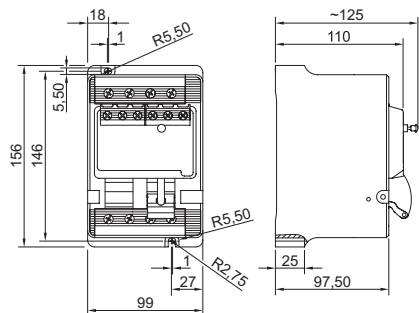

We reserve the right to make alterations to the technical data, dimensions, weights, designs and products available without notice. The illustrations cannot be considered binding.