

Components for system solutions

Residual current Circuit breaker

Circuit breaker

8562/54-4100-400 Art. No. 149648

STAHL



- Modular component for residual current monitoring
- Can be used for pulsating direct currents and alternating currents
- Protection against contact voltages

MY R. STAHL 8562A



The R. STAHL Series 8562 residual current circuit breaker is a component for residual current monitoring and switches systems in the event of residual currents – for the reliable protection of persons in hazardous areas. It is suitable for pulsating direct currents and alternating currents and is designed for rated operational currents of 16, 25 or 40 A and rated residual currents of 10, 30, 100, 300 and 500 mA.

Technical Data

Explosion Protection

Application range (zones)	1, 2
IECEX gas certificate	IECEX PTB 06.0062U
IECEX gas explosion protection	Ex de IIC T6 Gb
IECEX firedamp certificate	IECEX PTB 06.0062U
IECEX firedamp protection	Ex de I Mb
ATEX gas certificate	PTB 02 ATEX 1049 U
ATEX gas explosion protection	Ex II 2 G Ex de IIC T6 Gb
ATEX firedamp certificate	PTB 02 ATEX 1049 U
ATEX firedamp protection	Ex I M2 Ex de I Mb
FMus certificate	3033692
cFM certificate	3033692C
cCSA certificate	1850696
Certificates	ATEX (PTB), Brazil (ULB), China (CQST), IECEX (PTB)

Electrical Data

Rated operational current	40 A
Type of voltage	AC
Rated residual current	0.03 A
N-pole present	Yes
No. of poles	4

Ambient Conditions

Ambient temperature	-20 °C ... 60 °C
---------------------	------------------

Mechanical Data

Degree of protection (IP)	IP20
Enclosure material	Epoxy resin
Length	156 mm
Length in inches	6.14 in

Components for system solutions



Residual current Circuit breaker

Circuit breaker

8562/54-4100-400 Art. No. 149648

Mechanical Data

Depth of cut-out	97.5 mm
Mounting depth in inches	3.84 in
Weight	1.8 kg
Weight	3.97 lb

Technical Drawings – Subject to Alterations

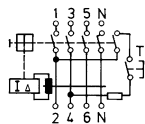

4-pole

Dimensional Drawings (All Dimensions in mm [inches]) – Subject to Alterations

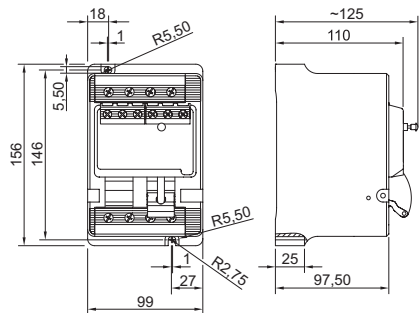

Residual current circuit breaker, 4-pole, 8562/54-...

We reserve the right to make alterations to the technical data, dimensions, weights, designs and products available without notice. The illustrations cannot be considered binding.