

8006/4-110-00 Art. No. 169537



- Can be used as motor, main or load disconnect switches, as well as control switches
- Rated operational voltage up to 690 V AC and 220 V DC
- Different switching arrangements available

MY R. STAHL 8006B



R. STAHL Series 8006/4 load and motor switches have isolating characteristics and AC-3 and DC-23 switching capacity. This makes them suitable for use as motor switches or main switches. They can also be used as control switches. They are available with different switching arrangements, from 2-pole to 12-pole.

Technical Data

Explosion Protection

Application range (zones)	1, 2
IECEX gas certificate	IECEX PTB 06.0018U
IECEX gas explosion protection	Ex db eb IIC T6 Gb
ATEX gas certificate	PTB 01 ATEX 1021 U
ATEX gas explosion protection	Ex II 2 G Ex db eb IIC T6 Gb
FMus certificate	3044997
cFM certificate	3044997C
cULus certificate	20131017-E182378
Certificates	ATEX (PTB), Brazil (ULB), Canada / USA (UL), Canada (FM), Canada (UL), China (CQST), IECEX (PTB), USA (FM), USA (UL)

Electrical Data

DC rated operational voltage	220 V
Rated operational current for AC	690 V / 25 A 500 V / 32 A
Rated operational current for DC	25 A
No. of poles	2
Short-circuit strength	20 kA
Max. short-circuit protection	35 A
Tripping characteristic	gG

Ambient Conditions

Ambient temperature	-50 °C ... +70 °C
Ambient temperature	-58 °F ... 158 °F

Mechanical Data

Degree of protection (IP)	IP00
Enclosure material	Epoxy resin
Contact material	Silver stannic oxide
Base	Without connection

8006/4-110-00 Art. No. 169537

Mechanical Data

Connection cross-section, solid	1.5 ... 6 mm ²
Connection cross-section, finely stranded	1.5 ... 6 mm ²
Number of switching positions	3
Assembly for switching arrangement	110
Contacts	2 NO
Service life, min.	2 x 10 ⁵ operating cycles
Detailed number of poles	2 P
Weight	260 g
Weight	0.57 lb

Mounting / Installation

Connection type	Screw terminal
Max. USA solid connection terminals	10 AWG

Technical Drawings – Subject to Alterations

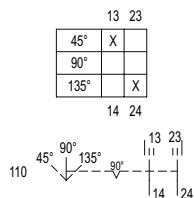

Dimensional Drawings (All Dimensions in mm [inches]) – Subject to Alterations

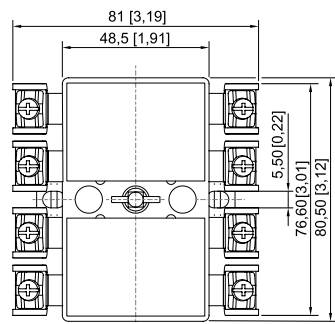
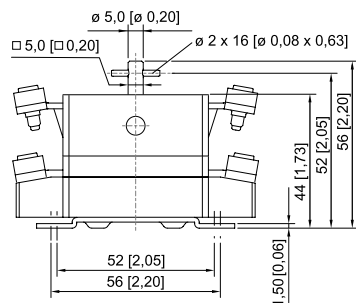

Load and motor switches Series 8006/4, 1-pole and 2-pole

8006/4-110-00 Art. No. 169537

Accessories

IP20 cover



1 pc.
An IP20 cover is required for each contact

Art. No.

204108

Rotary actuator Maxi BG736



8602C3-736-B-XXX-E08
Ø 64 mm
Handle colour: Black
Protective collar colour: Black
Front panel mounting
-20 °C ... 60 °C
Silicone-free: Yes
Lockable option (max. 3 times) can be determined using the enclosed closing parts.
Lockable handle position: Not defined.
In the unmounted assemblies, the standard label is 0/OFF-I/ON and the long coupling part is enclosed.
Other labels must be ordered separately.

Art. No.

318417

8602C3-736-S-XXX-E08
Ø 64 mm
Handle colour: Black
Protective collar colour: Black
Front panel mounting
-60 °C ... 70 °C
Silicone-free: No
Lockable option (max. 3 times) can be determined using the enclosed closing parts.
Lockable handle position: Not defined.
In the unmounted assemblies, the standard label is 0/OFF-I/ON and the long coupling part is enclosed.
Other labels must be ordered separately.

318418

8006/4-110-00 Art. No. 169537

Rotary actuator Maxi BG737



		Art. No.
	8602C3-737-B-XXX-E08 Ø 64 mm Handle colour: Red Protective collar colour: Yellow Front panel mounting -20 °C ... 60 °C Silicone-free: Yes Lockable option (max. 3 times) can be determined using the enclosed closing parts. Lockable handle position: Not defined. In the unmounted assemblies, the standard label is 0/OFF-I/ON and the long coupling part is enclosed. Other labels must be ordered separately.	318419
	8602C3-737-S-XXX-E08 Ø 64 mm Handle colour: Red Protective collar colour: Yellow Front panel mounting -60 °C ... 70 °C Silicone-free: No Lockable option (max. 3 times) can be determined using the enclosed closing parts. Lockable handle position: Not defined. In the unmounted assemblies, the standard label is 0/OFF-I/ON and the long coupling part is enclosed. Other labels must be ordered separately.	318420

Spare Parts

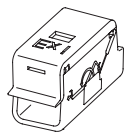
Ex i cover

		Art. No.
	for connecting intrinsically safe circuits (2 pcs)	213610

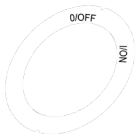
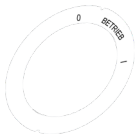
Labels for rotary actuator Maxi BG736, BG737

		Art. No.
	Dia. 58.5 0/OFF I/ON	274882
	Dia. 58.5 0 BETRIEB I	263982
	Dia. 58.5 0 I II	318507
	Dia. 58.5 I 0 II	318502

8006/4-110-00 Art. No. 169537

Labels for rotary actuator Maxi BG736, BG737

Art. No.



Dia. 58.5
0/OFF • I/ON

318459

We reserve the right to make alterations to the technical data, dimensions, weights, designs and products available without notice. The illustrations cannot be considered binding.