

Installation Equipment

Mushroom stay-put button With key

EM-STOP

8602C3-009-B .. MS1



- Pushbutton, mushroom pushbutton, mushroom stay-put button with key lock, mushroom stay-put button, twin pushbutton and illuminated pushbutton, rotary actuator, key-operated switch, potentiometer bezel and indicator lamp bezel
- One axial actuator can actuate up to four 8082 series contact elements
- Key-operated switches and rotary switches codable at any time as "latching/spring return" or "key not removable"

WebCode **8602A**



Thanks to their special technical features, the actuators from the 8602/3 series can withstand the most extreme conditions. In addition to the application option for use in ambient temperatures from -60 °C to +70 °C, the IP degree of protection, IP66, is maintained in accordance with EN 60529. It is also possible to actuate up to four contact elements from the 8082 series with a single axial actuator from the 8602/3 series.

The coding option of the key switches and rotary switches is innovative and one-of-a-kind. Integrated coding allows you to adjust the "latching/spring return" and/or "key not removable" functions at any time without additional accessories. A versatile set of accessories consisting of label holders and locking devices is available.

Technical Data

Explosion Protection

| | |
|---------------------------------|---|
| Application range (zones) | 1 2 21 22 |
| IECEX gas certificate | IECEX PTB 13.0047U |
| IECEX gas explosion protection | Ex eb IIC Gb |
| IECEX dust certificate | IECEX PTB 13.0047 U |
| IECEX dust explosion protection | Ex tb IIIC Db |
| ATEX gas certificate | PTB 13 ATEX 1019 U |
| ATEX gas explosion protection | Ex II 2 G Ex eb IIC Gb |
| ATEX dust certificate | PTB 13 ATEX 1019 U |
| ATEX dust explosion protection | Ex II 2 D Ex tb IIIC Db |
| UL gas certificate | E182378 V4 S2 |
| Certificates | ATEX (PTB), Brazil (ULB), Canada / USA (UL), EAC (CCVE), IECEX (PTB), India (PESO), Korea (KGS) |

Functional Safety

| | |
|-------------|---|
| SIL-capable | only with contact elements 8082/1, 8082/2, 8208/24-15 |
|-------------|---|

Ambient Conditions

| | |
|----------------------|--------------------|
| Ambient temperature | -20 °C ... +60 °C |
| Ambient temperature | -4 °F ... +140 °F |
| Storage temperature | -25 °C ... +60 °C |
| Storage temperature | -13 °F ... +140 °F |
| Use at the height of | < 2000 m |

Installation Equipment

Mushroom stay-put button With key

EM-STOP

8602C3-009-B .. MS1



Ambient Conditions

| | |
|-------------------------|---|
| Degree of contamination | 3 |
|-------------------------|---|

Mechanical Data

| | |
|------------------------------|----------------------------|
| Version | with key lock |
| Degree of protection (IP) | IP66 |
| Note on degree of protection | According to IEC/EN 60529 |
| Enclosure material | Polyamide |
| Silicone-free | Yes |
| Assembly | 009 |
| Diameter | 39 mm |
| Service life, min. | 10 ⁵ actuations |
| Impact strength (IEC 60079) | 7 J |
| Impact strength (IEC 62262) | min. IK08 |
| Colour | Yellow/red |
| Fastening | Thread type |
| Designation plate | With yellow backing plate |
| Seal | Standard |
| Closing | MS1 |
| Packaging unit | 1 |
| Weight | 0.075 kg |
| Weight | 0.17 lb |
| Description note | 2 keys enclosed. |

Mounting / Installation

| | |
|--------------------------|--------------|
| Tightening torque | 3 Nm |
| Tightening torque lbf in | 26.55 lbf in |

Dimensional Drawings (All Dimensions in mm [inches]) – Subject to Alterations

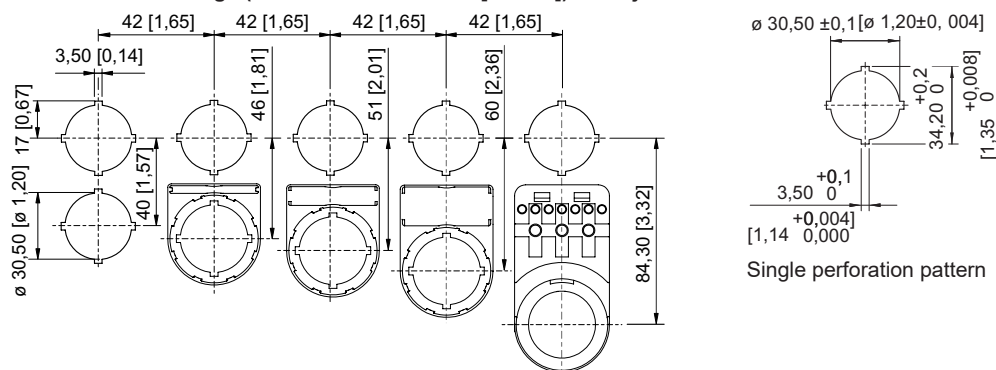

Standard cut-out with / without front label

Installation Equipment

Mushroom stay-put button With key

EM-STOP

8602C3-009-B .. MS1

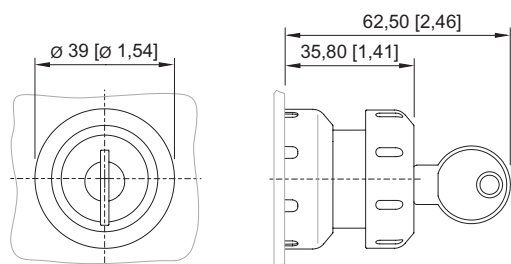





8602/3-006 Mushroom stay-put button with key lock red / black
 8602/3-009 Mushroom stay-put button with key lock red / yellow
 Actuator with axial actuation

Accessories

| Spare key | | Art. No. |
|--|-------------|----------|
|  | Closing MS1 | 107109 |

| Label holder | | Art. No. |
|---|--|----------|
|  | Size 1, without insert disc, 1-line label for actuators Ø 39 | 223566 |

| Insert discs for label holder | | Art. No. |
|--|--|----------|
|  | 1-line Plain Material: PVC Colour: White Self-adhesive | 238271 |
|  | 2-line Plain Material: PVC Colour: White Self-adhesive | 238272 |
|  | 3-line Plain Material: PVC Colour: White Self-adhesive | 238273 |

| Label, yellow, general | | Art. No. |
|--|-----------------------------|----------|
|  | for Ø 39 actuator (EM-STOP) | 223571 |

| Closing part | | Art. No. |
|--|--|----------|
|  | 8602C3-733-B for closing unused holes in cover, Ø 30.5 mm, NBR | 244306 |
| | 8602C3-733-S for closing unused holes in cover, Ø 30.5 mm, silicone | 244307 |

Installation Equipment









Mushroom stay-put button With key

EM-STOP

8602C3-009-B .. MS1



Spare Parts

| Protective collar | | Art. No. |
|--|--|----------|
|  | 8602C3-751 plastic/red for mushroom stay-put button with key lock/mushroom stay-put button Ø 39 BG006, BG009, BG010, BG012 | 257707 |
|  | 8602C3-751 plastic/yellow for mushroom stay-put button with key lock/mushroom stay-put button Ø 39 BG006, BG009, BG010, BG012 | 257708 |
| Label holder | | Art. No. |
|  | Size 2, without insert disc, 1- or 2-line label for actuators Ø 39 | 223567 |
|  | Size 3, without insert disc, 1-, 2- or 3-line label for actuators Ø 39 | 223568 |
| Special key | | Art. No. |
|  | for tightening plastic locking nut | 169101 |
| Pressure plates | | Art. No. |
|  | Ø 37 mm 3 contact elements | 215436 |
|  | Ø 48.5 mm 4 contact elements | 215437 |
| Holder for front installation | | Art. No. |
|  | 8602/3 holder for cable duct | 248673 |
| Adaptor for front installation | | Art. No. |
|  | 8602/3 Front installation for indicator lamp series 8010/6 and contact element series 8082/3 | 227038 |

Installation Equipment

Mushroom stay-put button With key

EM-STOP

8602C3-009-B .. MS1



8082/3 Contact element

Art. No.



for NC contact front installation

240898

for NO contact front installation

240899

We reserve the right to make alterations to the technical data, dimensions, weights, designs and products available without notice. The illustrations cannot be considered binding.