

8602C3-728-B-90X-E08



- Pushbutton, mushroom pushbutton, mushroom stay-put button with key lock, mushroom stay-put button, twin pushbutton and illuminated pushbutton, rotary actuator, key-operated switch, potentiometer bezel and indicator lamp bezel
- One axial actuator can actuate up to four 8082 series contact elements
- Key-operated switches and rotary switches codable at any time as "latching/spring return" or "key not removable"

WebCode **8602A**



Thanks to their special technical features, the actuators from the 8602/3 series can withstand the most extreme conditions. In addition to the application option for use in ambient temperatures from -60 °C to +70 °C, the IP degree of protection, IP66, is maintained in accordance with EN 60529. It is also possible to actuate up to four contact elements from the 8082 series with a single axial actuator from the 8602/3 series.

The coding option of the key switches and rotary switches is innovative and one-of-a-kind. Integrated coding allows you to adjust the "latching/spring return" and/or "key not removable" functions at any time without additional accessories. A versatile set of accessories consisting of label holders and locking devices is available.

Technical Data

Explosion Protection

Application range (zones)	1 2 21 22
IECEX gas certificate	IECEX PTB 13.0047U
IECEX gas explosion protection	Ex eb IIC Gb
IECEX dust certificate	IECEX PTB 13.0047 U
IECEX dust explosion protection	Ex tb IIIC Db
ATEX gas certificate	PTB 13 ATEX 1019 U
ATEX gas explosion protection	Ex II 2 G Ex eb IIC Gb
ATEX dust certificate	PTB 13 ATEX 1019 U
ATEX dust explosion protection	Ex II 2 D Ex tb IIIC Db
UL gas certificate	E182378 V4 S2
Inmetro gas certificate	UL-BR 14.0380U
Inmetro dust certificate	UL-BR 14.0380U
Certificates	ATEX (PTB), Brazil (ULB), Canada / USA (UL), EAC (CCVE), IECEX (PTB), India (PESO), Korea (KGS)

Ambient Conditions

Ambient temperature	-20 °C ... +60 °C
Ambient temperature	-4 °F ... +140 °F
Storage temperature	-25 °C ... +60 °C
Storage temperature	-13 °F ... +140 °F
Use at the height of	< 2000 m

8602C3-728-B-90X-E08

Ambient Conditions

Degree of contamination	3
-------------------------	---

Mechanical Data

Version	increased height, bk-bk
Degree of protection (IP)	IP66
Note on degree of protection	According to IEC/EN 60529
Enclosure material	Polyamide
Silicone-free	Yes
Assembly	728
Diameter	65 mm
Service life, min.	10 ⁵ actuations
Impact strength (IEC 60079)	7 J
Impact strength (IEC 62262)	min. IK08
Handle colour	Black
Protective collar colour	Black
Fastening	Thread type
Designation plate	0/OFF – I/ON
Seal	Standard
Lockable in	90°
Packaging unit	1
Weight	0.04 kg
Weight	0.09 lb
Description note	Lockable option (max. 3 times) can be determined using the enclosed closing parts. Lockable handle position: 90°. In the unmounted assemblies, the standard label is 0/OFF-I/ON and the long coupling part is enclosed. Other labels must be ordered separately.

Mounting / Installation

Mounting type	Not installed
Tightening torque	3 Nm
Tightening torque lbf in	26.55 lbf in

Dimensional Drawings (All Dimensions in mm [inches]) – Subject to Alterations

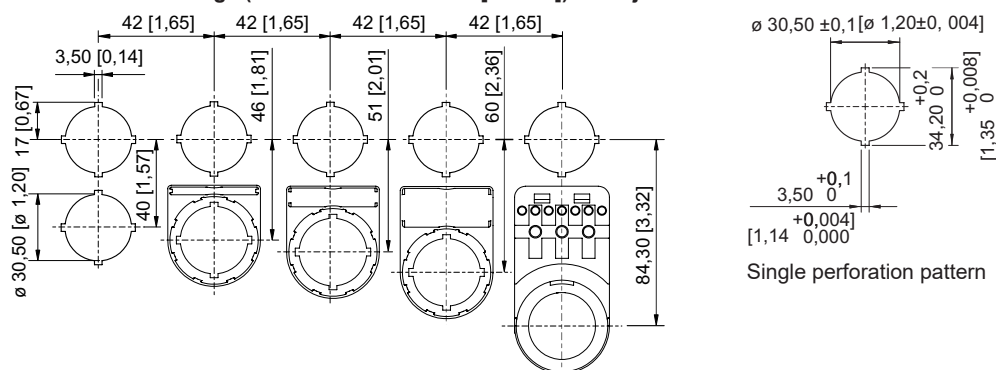

Standard cut-out with / without front label

8602C3-728-B-90X-E08

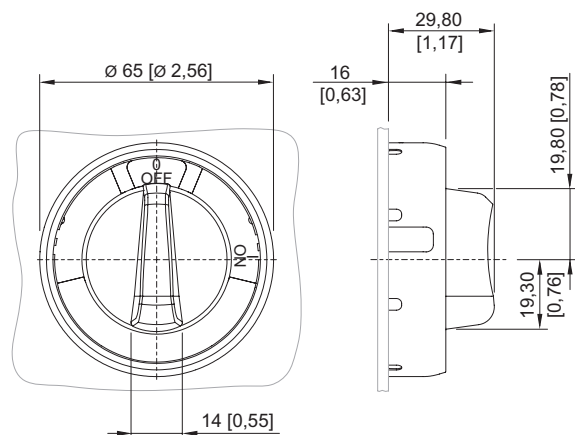

8602/3-728 Rotary actuator, black handle, red protective collar
 8602/3-729 Rotary actuator, red handle, black protective collar
 Actuator with radial actuation

Accessories

Labels for large BG 728, BG 729, BG 730, BG 731 rotary actuator

Art. No.





	Ø 58 0/OFF I/ON	227004
	Ø 58 0 BETRIEB I	227005
	Ø 58 0 I II	227006
	Ø 58 I 0 II	227007
	Ø 58 I II	227008
	Ø 58 0 I	227009
	Ø 58 I 0 I 0	227010

Installation Equipment

Large rotary actuator Increased height, BK-BK



8602C3-728-B-90X-E08

	Ø 58 HAND 0 AUTO	227011
	Ø 58 0/OFF 0 I/ON	227012
	Ø 58, yellow 0/OFF I/ON	227013
	Ø 58 0 I (90°)	273760
	Ø 58 plain	227014

Cylinder lock

Art. No.

	for closing (bracket Ø 3)	107115
--	---------------------------	--------

Spare Parts

Special key

Art. No.

	for tightening plastic locking nut	169101
--	------------------------------------	--------

Adaptor for front installation

Art. No.

	8602/3 Front installation for control switch series 8008	260081
--	--	--------

We reserve the right to make alterations to the technical data, dimensions, weights, designs and products available without notice. The illustrations cannot be considered binding.