

8602C3-734-S-45H-E08



- Pushbutton, mushroom pushbutton, mushroom stay-put button with key lock, mushroom stay-put button, twin pushbutton and illuminated pushbutton, rotary actuator, key-operated switch, potentiometer bezel and indicator lamp bezel
- One axial actuator can actuate up to four 8082 series contact elements
- Key-operated switches and rotary switches codable at any time as "latching/spring return" or "key not removable"

WebCode **8602A**



Thanks to their special technical features, the actuators from the 8602/3 series can withstand the most extreme conditions. In addition to the application option for use in ambient temperatures from -60 °C to +70 °C, the IP degree of protection, IP66, is maintained in accordance with EN 60529. It is also possible to actuate up to four contact elements from the 8082 series with a single axial actuator from the 8602/3 series.

The coding option of the key switches and rotary switches is innovative and one-of-a-kind. Integrated coding allows you to adjust the "latching/spring return" and/or "key not removable" functions at any time without additional accessories. A versatile set of accessories consisting of label holders and locking devices is available.

### Technical Data

#### Explosion Protection

Application range (zones)	1 2 21 22
IECEX gas certificate	IECEX PTB 13.0047U
IECEX gas explosion protection	Ex eb IIC Gb
IECEX dust certificate	IECEX PTB 13.0047 U
IECEX dust explosion protection	Ex tb IIIC Db
ATEX gas certificate	PTB 13 ATEX 1019 U
ATEX gas explosion protection	Ex II 2 G Ex eb IIC Gb
ATEX dust certificate	PTB 13 ATEX 1019 U
ATEX dust explosion protection	Ex II 2 D Ex tb IIIC Db
UL gas certificate	E182378 V4 S2
Inmetro gas certificate	UL-BR 14.0380U
Inmetro dust certificate	UL-BR 14.0380U
Certificates	ATEX (PTB), Brazil (ULB), Canada / USA (UL), EAC (CCVE), IECEX (PTB), India (PESO), Korea (KGS)

#### Ambient Conditions

Ambient temperature	-60 °C ... +70 °C
Ambient temperature	-76 °F ... +158 °F
Storage temperature	-60 °C ... +70 °C
Storage temperature	-76 °F ... +158 °F
Use at the height of	< 2000 m

### 8602C3-734-S-45H-E08

#### Ambient Conditions

Degree of contamination	3
-------------------------	---

#### Mechanical Data

Version	lockable
Degree of protection (IP)	IP66
Note on degree of protection	According to IEC/EN 60529
Enclosure material	Polyamide
Silicone-free	No
Assembly	734
Diameter	39 mm
Service life, min.	10 <sup>5</sup> actuations
Impact strength (IEC 60079)	7 J
Impact strength (IEC 62262)	min. IK08
Colour	Black
Fastening	Thread type
Designation plate	0/OFF – I/ON
Seal	Silicone
Lockable in	One pos. with one lock
Packaging unit	1
Weight	0.04 kg
Weight	0.09 lb
Decription note	0/OFF-I/ON label provided separately. Cylinder lock not enclosed. Other labels must be ordered separately.

#### Mounting / Installation

Tightening torque	3 Nm
Tightening torque lbf in	26.55 lbf in

#### Dimensional Drawings (All Dimensions in mm [inches]) – Subject to Alterations

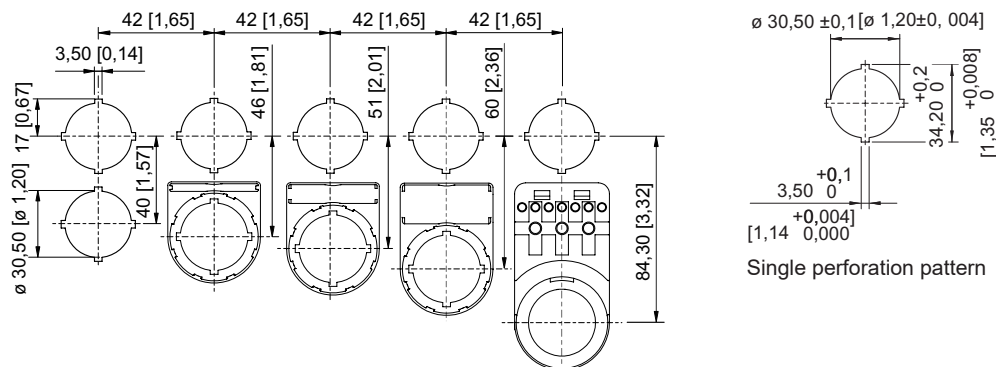





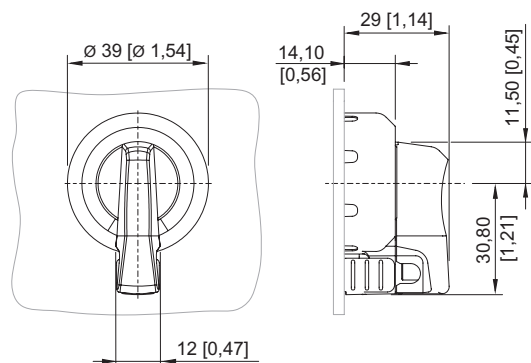

Standard cut-out with / without front label

8602C3-734-S-45H-E08





8602/3-734 Rotary actuator, padlockable using 1 lock  
Actuator with radial actuation

### Accessories

Label holder		Art. No.
	Size 1, without insert disc, 1-line label for actuators Ø 39	223566
Insert discs for label holder		Art. No.
	1-line Plain Material: PVC Colour: White Self-adhesive	238271
	2-line Plain Material: PVC Colour: White Self-adhesive	238272
	3-line Plain Material: PVC Colour: White Self-adhesive	238273
Labels for small BG 732, BG 734 rotary actuator		Art. No.
	Ø 30.8 0/OFF I/ON	227489
	Ø 30.8 0 I	227490
	Ø 30.8 I 0 II	227491

8602C3-734-S-45H-E08

	Ø 30.8 0 I	227492
	Ø 30.8 HAND 0 AUTO	227494
	Ø 30.8 AUS EIN	269983
	Ø 30.8 AUTO 0 HAND EIN	269984
	Ø 30.8 AUTO 0 HAND	269985

**Labels for small BG 732, BG 734 rotary actuator and BG 726, BG 727 axial rotary actuator**

**Art. No.**

	Ø 30.8 plain	227495
--	-----------------	--------

**Closing part**

**Art. No.**

	8602C3-733-B for closing unused holes in cover, Ø 30.5 mm, NBR	244306
	8602C3-733-S for closing unused holes in cover, Ø 30.5 mm, silicone	244307

**Cylinder lock**



**Art. No.**

	for closing (bracket Ø 3)	107115
--	---------------------------	--------

**Spare Parts**

**Label holder**

**Art. No.**

	Size 2, without insert disc, 1- or 2-line label for actuators Ø 39	223567
	Size 3, without insert disc, 1-, 2- or 3-line label for actuators Ø 39	223568

# Installation Equipment

## Rotary actuator, small Padlockable



8602C3-734-S-45H-E08

### Special key

### Art. No.



for tightening plastic locking nut

169101

### Adaptor for front installation

### Art. No.



8602/3 Front installation for control switch series 8008

260081

We reserve the right to make alterations to the technical data, dimensions, weights, designs and products available without notice. The illustrations cannot be considered binding.