

Installation Equipment

Mushroom pushbutton 55 mm

Red

8602C3-014-B



- Pushbutton, mushroom pushbutton, mushroom stay-put button with key lock, mushroom stay-put button, twin pushbutton and illuminated pushbutton, rotary actuator, key-operated switch, potentiometer bezel and indicator lamp bezel
- One axial actuator can actuate up to four 8082 series contact elements
- Key-operated switches and rotary switches codable at any time as "latching/spring return" or "key not removable"

WebCode **8602A**



Thanks to their special technical features, the actuators from the 8602/3 series can withstand the most extreme conditions. In addition to the application option for use in ambient temperatures from -60 °C to +70 °C, the IP degree of protection, IP66, is maintained in accordance with EN 60529. It is also possible to actuate up to four contact elements from the 8082 series with a single axial actuator from the 8602/3 series.

The coding option of the key switches and rotary switches is innovative and one-of-a-kind. Integrated coding allows you to adjust the "latching/spring return" and/or "key not removable" functions at any time without additional accessories. A versatile set of accessories consisting of label holders and locking devices is available.

Technical Data

Explosion Protection

Application range (zones)	1 2 21 22
IECEX gas certificate	IECEX PTB 13.0047U
IECEX gas explosion protection	Ex eb IIC Gb
IECEX dust certificate	IECEX PTB 13.0047 U
IECEX dust explosion protection	Ex tb IIIC Db
ATEX gas certificate	PTB 13 ATEX 1019 U
ATEX gas explosion protection	Ex II 2 G Ex eb IIC Gb
ATEX dust certificate	PTB 13 ATEX 1019 U
ATEX dust explosion protection	Ex II 2 D Ex tb IIIC Db
UL gas certificate	E182378 V4 S2
Certificates	ATEX (PTB), Brazil (ULB), Canada / USA (UL), EAC (CCVE), IECEX (PTB), India (PESO), Korea (KGS)

Ambient Conditions

Ambient temperature	-20 °C ... +60 °C
Ambient temperature	-4 °F ... +140 °F
Storage temperature	-25 °C ... +60 °C
Storage temperature	-13 °F ... +140 °F
Use at the height of	< 2000 m
Degree of contamination	3

Installation Equipment

Mushroom pushbutton 55 mm

Red

8602C3-014-B



Mechanical Data

Version	55 mm
Degree of protection (IP)	IP66
Note on degree of protection	According to IEC/EN 60529
Enclosure material	Polyamide
Silicone-free	Yes
Assembly	014
Diameter	55 mm
Service life, min.	10 ⁵ actuations
Impact strength (IEC 60079)	7 J
Impact strength (IEC 62262)	min. IK08
Colour	Black/red
Fastening	Thread type
Designation plate	Red, blank disc without text
Seal	Standard
Packaging unit	1
Weight	0.055 kg
Weight	0.12 lb

Mounting / Installation

Tightening torque	3 Nm
Tightening torque lbf in	26.55 lbf in

Dimensional Drawings (All Dimensions in mm [inches]) – Subject to Alterations

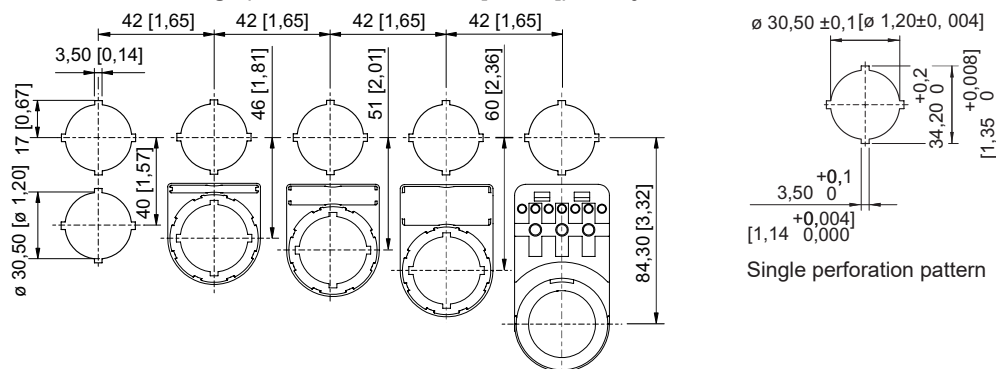

Standard cut-out with / without front label

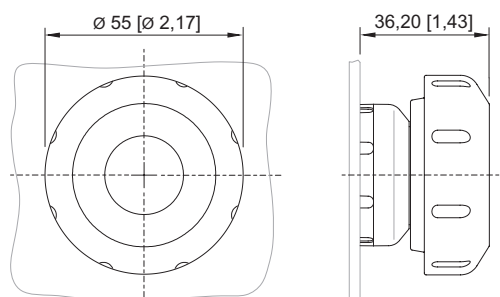

8602/3-014 Mushroom stay-put button red / black
 8602/3-703 Mushroom stay-put button black / black
 Actuator with axial actuation











Accessories

Installation Equipment
Mushroom pushbutton 55 mm
Red
8602C3-014-B



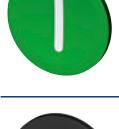

Designation plate for pushbutton and selector switch

Art. No.

	Blue Blank disc without text	215427
	Yellow Blank disc without text	215428
	Red Blank disc without text	215423
	Green Blank disc without text	215424
	White Blank disc without text	215426
	Black Blank disc without text	215425
	Black Text: I	227747
	Green Text: I	227750
	Black Text: EIN	227808
	White Text: I	227751
	Black Text: II	227754

Installation Equipment
 Mushroom pushbutton 55 mm
 Red
 8602C3-014-B



	Green Text: II	227753
	Red Text: O	227740
	Black Text: O	227741
	Red Symbol: Right arrow	272628
	Black Symbol: Straight arrow 45°	227778
	Red Text: OFF	227814
	Red Text: AUS	227810
	Black Text: AUS	227811
	Red Text: STOP	227804
	Blue Text: RESET	227926
	Green Text: START	227801

Spare Parts

Special key

Art. No.

Installation Equipment
 Mushroom pushbutton 55 mm
 Red
 8602C3-014-B



	for tightening plastic locking nut	169101
--	------------------------------------	--------

Pressure plates **Art. No.**

	Ø 37 mm 3 contact elements	215436
--	-------------------------------	--------

	Ø 48.5 mm 4 contact elements	215437
--	---------------------------------	--------

Holder for front installation **Art. No.**

	8602/3 holder for cable duct	248673
--	------------------------------	--------

Adaptor for front installation **Art. No.**

	8602/3 Front installation for indicator lamp series 8010/6 and contact element series 8082/3	227038
--	--	--------

8082/3 Contact element **Art. No.**

	for NC contact front installation	240898
	for NO contact front installation	240899

We reserve the right to make alterations to the technical data, dimensions, weights, designs and products available without notice. The illustrations cannot be considered binding.