

8602C3-727-B-M03-03-E03



- Pushbutton, mushroom pushbutton, mushroom stay-put button with key lock, mushroom stay-put button, twin pushbutton and illuminated pushbutton, rotary actuator, key-operated switch, potentiometer bezel and indicator lamp bezel
- One axial actuator can actuate up to four 8082 series contact elements
- Key-operated switches and rotary switches codable at any time as "latching/spring return" or "key not removable"

WebCode **8602A**



Thanks to their special technical features, the actuators from the 8602/3 series can withstand the most extreme conditions. In addition to the application option for use in ambient temperatures from -60 °C to +70 °C, the IP degree of protection, IP66, is maintained in accordance with EN 60529. It is also possible to actuate up to four contact elements from the 8082 series with a single axial actuator from the 8602/3 series.

The coding option of the key switches and rotary switches is innovative and one-of-a-kind. Integrated coding allows you to adjust the "latching/spring return" and/or "key not removable" functions at any time without additional accessories. A versatile set of accessories consisting of label holders and locking devices is available.

Technical Data

Explosion Protection

| | |
|---------------------------------|---|
| Application range (zones) | 1 2 21 22 |
| IECEX gas certificate | IECEX PTB 13.0047U |
| IECEX gas explosion protection | Ex eb IIC Gb |
| IECEX dust certificate | IECEX PTB 13.0047 U |
| IECEX dust explosion protection | Ex tb IIIC Db |
| ATEX gas certificate | PTB 13 ATEX 1019 U |
| ATEX gas explosion protection | Ex II 2 G Ex eb IIC Gb |
| ATEX dust certificate | PTB 13 ATEX 1019 U |
| ATEX dust explosion protection | Ex II 2 D Ex tb IIIC Db |
| UL gas certificate | E182378 V4 S2 |
| Certificates | ATEX (PTB), Brazil (ULB), Canada / USA (UL), EAC (CCVE), IECEX (PTB), India (PESO), Korea (KGS) |

Ambient Conditions



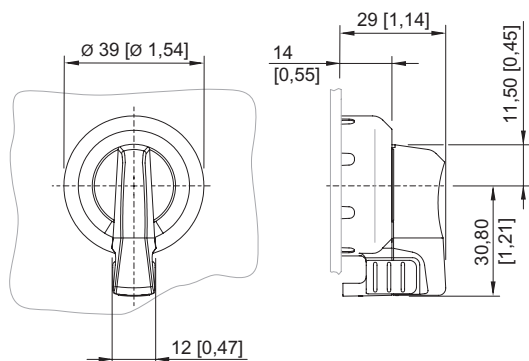

| | |
|-------------------------|--------------------|
| Ambient temperature | -20 °C ... +60 °C |
| Ambient temperature | -4 °F ... +140 °F |
| Storage temperature | -25 °C ... +60 °C |
| Storage temperature | -13 °F ... +140 °F |
| Use at the height of | < 2000 m |
| Degree of contamination | 3 |

8602C3-727-B-M03-03-E03



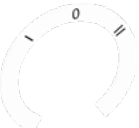

8602/3-727 Axial rotary actuator, lockable
Actuator with axial actuation

Accessories

| Label holder | | Art. No. |
|--|--|----------|
|  | Size 1, without insert disc, 1-line label for actuators Ø 39 | 223566 |
| Insert discs for label holder | | Art. No. |
|  | 1-line Plain Material: PVC Colour: White Self-adhesive | 238271 |
|  | 2-line Plain Material: PVC Colour: White Self-adhesive | 238272 |
|  | 3-line Plain Material: PVC Colour: White Self-adhesive | 238273 |
| Labels for small BG 732, BG 734 rotary actuator and BG 726, BG 727 axial rotary actuator | | Art. No. |
|  | Ø 30.8 plain | 227495 |
| Labels for axial BG 726, BG 727 rotary actuator | | Art. No. |
|  | Ø 30.8 I 0 II | 240474 |



8602C3-727-B-M03-03-E03

| | | |
|--|-------------------------------|--------|
|  | <p>Ø 30.8 HAND 0 AUTO</p> | 240477 |
|--|-------------------------------|--------|



| Closing part | | Art. No. |
|--|--|----------|
|  | <p>8602C3-733-B for closing unused holes in cover, Ø 30.5 mm, NBR</p> | 244306 |
| | <p>8602C3-733-S for closing unused holes in cover, Ø 30.5 mm, silicone</p> | 244307 |

| Cylinder lock | | Art. No. |
|--|---------------------------|----------|
|  | for closing (bracket Ø 3) | 107115 |

Spare Parts

| Label holder | | Art. No. |
|--|---|----------|
|  | <p>Size 2, without insert disc, 1- or 2-line label for actuators Ø 39</p> | 223567 |
|  | <p>Size 3, without insert disc, 1-, 2- or 3-line label for actuators Ø 39</p> | 223568 |

| Special key | | Art. No. |
|--|------------------------------------|----------|
|  | for tightening plastic locking nut | 169101 |

| Pressure plates | | Art. No. |
|--|--|----------|
|  | <p>for key-operated switch and axial rotary actuator 1 to 2 contact elements</p> | 253627 |
|  | <p>for key-operated switch and axial rotary actuator 3 to 4 contact elements</p> | 221707 |

| Holder for front installation | | Art. No. |
|--|------------------------------|----------|
|  | 8602/3 holder for cable duct | 248673 |

Installation Equipment

Rotary actuator, small Padlockable



8602C3-727-B-M03-03-E03

Adaptor for front installation

Art. No.



8602/3 Front installation for indicator lamp series 8010/6 and contact element series 8082/3

227038

8082/3 Contact element

Art. No.



for NC contact front installation

240898

for NO contact front installation

240899

We reserve the right to make alterations to the technical data, dimensions, weights, designs and products available without notice. The illustrations cannot be considered binding.