

8602C3-729-S-00X-E02



- Pushbutton, mushroom pushbutton, mushroom stay-put button with key lock, mushroom stay-put button, twin pushbutton and illuminated pushbutton, rotary actuator, key-operated switch, potentiometer bezel and indicator lamp bezel
- One axial actuator can actuate up to four 8082 series contact elements
- Key-operated switches and rotary switches codable at any time as "latching/spring return" or "key not removable"

WebCode **8602A**



Thanks to their special technical features, the actuators from the 8602/3 series can withstand the most extreme conditions. In addition to the application option for use in ambient temperatures from -60 °C to +70 °C, the IP degree of protection, IP66, is maintained in accordance with EN 60529. It is also possible to actuate up to four contact elements from the 8082 series with a single axial actuator from the 8602/3 series.

The coding option of the key switches and rotary switches is innovative and one-of-a-kind. Integrated coding allows you to adjust the "latching/spring return" and/or "key not removable" functions at any time without additional accessories. A versatile set of accessories consisting of label holders and locking devices is available.

### Technical Data

#### Explosion Protection

Application range (zones)	1 2 21 22
IECEX gas certificate	IECEX PTB 13.0047U
IECEX gas explosion protection	Ex eb IIC Gb
IECEX dust certificate	IECEX PTB 13.0047 U
IECEX dust explosion protection	Ex tb IIIC Db
ATEX gas certificate	PTB 13 ATEX 1019 U
ATEX gas explosion protection	Ex II 2 G Ex eb IIC Gb
ATEX dust certificate	PTB 13 ATEX 1019 U
ATEX dust explosion protection	Ex II 2 D Ex tb IIIC Db
UL gas certificate	E182378 V4 S2
Certificates	ATEX (PTB), Brazil (ULB), Canada / USA (UL), EAC (CCVE), IECEX (PTB), India (PESO), Korea (KGS)

#### Ambient Conditions

Ambient temperature	-60 °C ... +70 °C
Ambient temperature	-76 °F ... +158 °F
Storage temperature	-60 °C ... +70 °C
Storage temperature	-76 °F ... +158 °F
Use at the height of	< 2000 m
Degree of contamination	3



8602C3-729-S-00X-E02

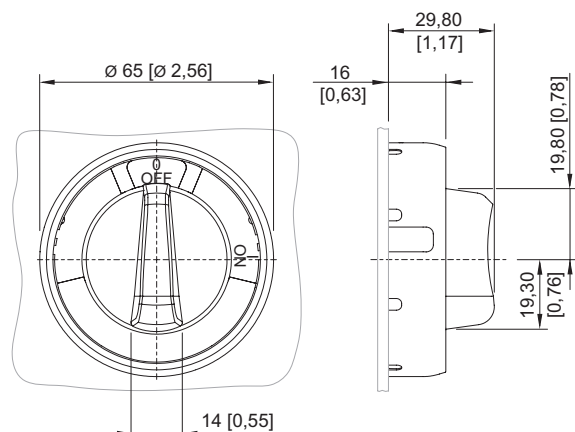

8602/3-728 Rotary actuator, black handle, red protective collar  
 8602/3-729 Rotary actuator, red handle, black protective collar  
 Actuator with radial actuation

### Accessories

#### Labels for large BG 728, BG 729, BG 730, BG 731 rotary actuator

Art. No.





	Ø 58 0/OFF I/ON	227004
	Ø 58 0 BETRIEB I	227005
	Ø 58 0 I II	227006
	Ø 58 I 0 II	227007
	Ø 58 I II	227008
	Ø 58 0 I	227009
	Ø 58 I 0 I 0	227010

# Installation Equipment

Large rotary actuator Increased height, red-yellow



8602C3-729-S-00X-E02

	Ø 58 HAND 0 AUTO	227011
	Ø 58 0/OFF 0 I/ON	227012
	Ø 58, yellow 0/OFF I/ON	227013
	Ø 58 0 I (90°)	273760
	Ø 58 plain	227014

## Cylinder lock

Art. No.

	for closing (bracket Ø 3)	107115
--	---------------------------	--------

## Spare Parts

### Special key

Art. No.

	for tightening plastic locking nut	169101
--	------------------------------------	--------

### Adaptor for front installation

Art. No.

	8602/3 Front installation for control switch series 8008	260081
--	--	--------

We reserve the right to make alterations to the technical data, dimensions, weights, designs and products available without notice. The illustrations cannot be considered binding.