

8602C3-006-B .. MS3



- Pushbutton, mushroom pushbutton, mushroom stay-put button with key lock, mushroom stay-put button, twin pushbutton and illuminated pushbutton, rotary actuator, key-operated switch, potentiometer bezel and indicator lamp bezel
- One axial actuator can actuate up to four 8082 series contact elements
- Key-operated switches and rotary switches codable at any time as "latching/spring return" or "key not removable"

WebCode **8602A**



Thanks to their special technical features, the actuators from the 8602/3 series can withstand the most extreme conditions. In addition to the application option for use in ambient temperatures from -60 °C to +70 °C, the IP degree of protection, IP66, is maintained in accordance with EN 60529. It is also possible to actuate up to four contact elements from the 8082 series with a single axial actuator from the 8602/3 series.

The coding option of the key switches and rotary switches is innovative and one-of-a-kind. Integrated coding allows you to adjust the "latching/spring return" and/or "key not removable" functions at any time without additional accessories. A versatile set of accessories consisting of label holders and locking devices is available.

### Technical Data

#### Explosion Protection

|                                 |                                                                                                 |
|---------------------------------|-------------------------------------------------------------------------------------------------|
| Application range (zones)       | 1<br>2<br>21<br>22                                                                              |
| IECEX gas certificate           | IECEX PTB 13.0047U                                                                              |
| IECEX gas explosion protection  | Ex eb IIC Gb                                                                                    |
| IECEX dust certificate          | IECEX PTB 13.0047 U                                                                             |
| IECEX dust explosion protection | Ex tb IIIC Db                                                                                   |
| ATEX gas certificate            | PTB 13 ATEX 1019 U                                                                              |
| ATEX gas explosion protection   | Ex II 2 G Ex eb IIC Gb                                                                          |
| ATEX dust certificate           | PTB 13 ATEX 1019 U                                                                              |
| ATEX dust explosion protection  | Ex II 2 D Ex tb IIIC Db                                                                         |
| UL gas certificate              | E182378 V4 S2                                                                                   |
| Certificates                    | ATEX (PTB), Brazil (ULB), Canada / USA (UL), EAC (CCVE), IECEX (PTB), India (PESO), Korea (KGS) |

#### Functional Safety

|             |                                                       |
|-------------|-------------------------------------------------------|
| SIL-capable | only with contact elements 8082/1, 8082/2, 8208/24-15 |
|-------------|-------------------------------------------------------|

#### Ambient Conditions

|                      |                    |
|----------------------|--------------------|
| Ambient temperature  | -20 °C ... +60 °C  |
| Ambient temperature  | -4 °F ... +140 °F  |
| Storage temperature  | -25 °C ... +60 °C  |
| Storage temperature  | -13 °F ... +140 °F |
| Use at the height of | < 2000 m           |

8602C3-006-B .. MS3

### Ambient Conditions

|                         |   |
|-------------------------|---|
| Degree of contamination | 3 |
|-------------------------|---|

### Mechanical Data

|                              |                            |
|------------------------------|----------------------------|
| Version                      | with key lock              |
| Degree of protection (IP)    | IP66                       |
| Note on degree of protection | According to IEC/EN 60529  |
| Enclosure material           | Polyamide                  |
| Silicone-free                | Yes                        |
| Assembly                     | 006                        |
| Diameter                     | 39 mm                      |
| Service life, min.           | 10 <sup>5</sup> actuations |
| Impact strength (IEC 60079)  | 7 J                        |
| Impact strength (IEC 62262)  | min. IK08                  |
| Colour                       | Red/black                  |
| Fastening                    | Thread type                |
| Seal                         | Standard                   |
| Closing                      | MS3                        |
| Weight                       | 0.075 kg                   |
| Weight                       | 0.17 lb                    |
| Description note             | 2 keys enclosed.           |

### Mounting / Installation

|                          |              |
|--------------------------|--------------|
| Tightening torque        | 3 Nm         |
| Tightening torque lbf in | 26.55 lbf in |

### Dimensional Drawings (All Dimensions in mm [inches]) – Subject to Alterations

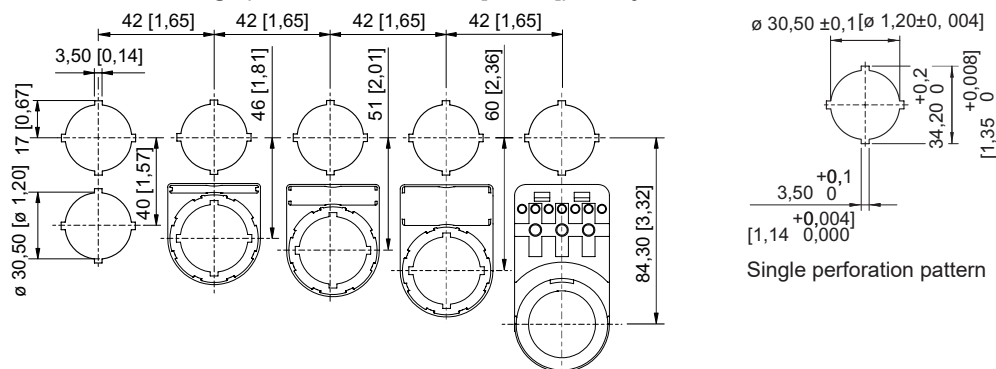

Standard cut-out with / without front label

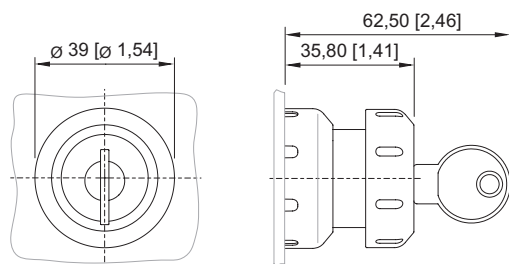

8602/3-006 Mushroom stay-put button with key lock red / black  
 8602/3-009 Mushroom stay-put button with key lock red / yellow  
 Actuator with axial actuation

# Installation Equipment

## Mushroom stay-put button With key







8602C3-006-B .. MS3

### Accessories

| Spare key                                                                        |             | Art. No. |
|----------------------------------------------------------------------------------|-------------|----------|
|  | Closing MS3 | 272646   |

| Label holder                                                                     |                                                              | Art. No. |
|----------------------------------------------------------------------------------|--------------------------------------------------------------|----------|
|  | Size 1, without insert disc, 1-line label for actuators Ø 39 | 223566   |

| Insert discs for label holder                                                      |                                                                    | Art. No. |
|------------------------------------------------------------------------------------|--------------------------------------------------------------------|----------|
|    | 1-line<br>Plain<br>Material: PVC<br>Colour: White<br>Self-adhesive | 238271   |
|   | 2-line<br>Plain<br>Material: PVC<br>Colour: White<br>Self-adhesive | 238272   |
|  | 3-line<br>Plain<br>Material: PVC<br>Colour: White<br>Self-adhesive | 238273   |

| Closing part                                                                       |                                                                        | Art. No. |
|------------------------------------------------------------------------------------|------------------------------------------------------------------------|----------|
|  | 8602C3-733-B<br>for closing unused holes in cover, Ø 30.5 mm, NBR      | 244306   |
|                                                                                    | 8602C3-733-S<br>for closing unused holes in cover, Ø 30.5 mm, silicone | 244307   |

### Spare Parts









| Protective collar                                                                  |                                                                                                                                  | Art. No. |
|------------------------------------------------------------------------------------|----------------------------------------------------------------------------------------------------------------------------------|----------|
|  | 8602C3-751 plastic/red for mushroom stay-put button with key lock/mushroom stay-put button Ø 39<br>BG006, BG009, BG010, BG012    | 257707   |
|  | 8602C3-751 plastic/yellow for mushroom stay-put button with key lock/mushroom stay-put button Ø 39<br>BG006, BG009, BG010, BG012 | 257708   |

# Installation Equipment

## Mushroom stay-put button With key



8602C3-006-B .. MS3

| Label holder                                                                       |                                                                                              | Art. No. |
|------------------------------------------------------------------------------------|----------------------------------------------------------------------------------------------|----------|
|    | Size 2, without insert disc, 1- or 2-line label for actuators Ø 39                           | 223567   |
|    | Size 3, without insert disc, 1-, 2- or 3-line label for actuators Ø 39                       | 223568   |
| Special key                                                                        |                                                                                              | Art. No. |
|    | for tightening plastic locking nut                                                           | 169101   |
| Pressure plates                                                                    |                                                                                              | Art. No. |
|   | Ø 37 mm<br>3 contact elements                                                                | 215436   |
|  | Ø 48.5 mm<br>4 contact elements                                                              | 215437   |
| Holder for front installation                                                      |                                                                                              | Art. No. |
|  | 8602/3 holder for cable duct                                                                 | 248673   |
| Adaptor for front installation                                                     |                                                                                              | Art. No. |
|  | 8602/3 Front installation for indicator lamp series 8010/6 and contact element series 8082/3 | 227038   |
| 8082/3 Contact element                                                             |                                                                                              | Art. No. |
|  | for NC contact front installation                                                            | 240898   |
|                                                                                    | for NO contact front installation                                                            | 240899   |

We reserve the right to make alterations to the technical data, dimensions, weights, designs and products available without notice. The illustrations cannot be considered binding.