

8602C3-008-B-M01-02-MS02



- Pushbutton, mushroom pushbutton, mushroom stay-put button with key lock, mushroom stay-put button, twin pushbutton and illuminated pushbutton, rotary actuator, key-operated switch, potentiometer bezel and indicator lamp bezel
- One axial actuator can actuate up to four 8082 series contact elements
- Key-operated switches and rotary switches codable at any time as "latching/spring return" or "key not removable"

WebCode **8602A**



Thanks to their special technical features, the actuators from the 8602/3 series can withstand the most extreme conditions. In addition to the application option for use in ambient temperatures from -60 °C to +70 °C, the IP degree of protection, IP66, is maintained in accordance with EN 60529. It is also possible to actuate up to four contact elements from the 8082 series with a single axial actuator from the 8602/3 series.

The coding option of the key switches and rotary switches is innovative and one-of-a-kind. Integrated coding allows you to adjust the "latching/spring return" and/or "key not removable" functions at any time without additional accessories. A versatile set of accessories consisting of label holders and locking devices is available.

Technical Data

Explosion Protection

Application range (zones)	1 2 21 22
IECEX gas certificate	IECEX PTB 13.0047U
IECEX gas explosion protection	Ex eb IIC Gb
IECEX dust certificate	IECEX PTB 13.0047 U
IECEX dust explosion protection	Ex tb IIIC Db
ATEX gas certificate	PTB 13 ATEX 1019 U
ATEX gas explosion protection	Ex II 2 G Ex eb IIC Gb
ATEX dust certificate	PTB 13 ATEX 1019 U
ATEX dust explosion protection	Ex II 2 D Ex tb IIIC Db
UL gas certificate	E182378 V4 S2
Certificates	ATEX (PTB), Brazil (ULB), Canada / USA (UL), EAC (CCVE), IECEX (PTB), India (PESO), Korea (KGS)

Ambient Conditions

Ambient temperature	-20 °C ... +60 °C
Ambient temperature	-4 °F ... +140 °F
Storage temperature	-25 °C ... +60 °C
Storage temperature	-13 °F ... +140 °F
Use at the height of	< 2000 m
Degree of contamination	3

8602C3-008-B-M01-02-MS02

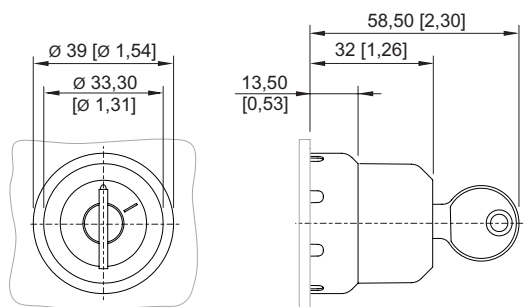

8602/3-008 MS Key-operated switch
Actuator with axial actuation

Accessories

Spare key



Closing MS2

Art. No.

272645

Label holder



Size 1, without insert disc, 1-line label
for actuators Ø 39

Art. No.

223566

Insert discs for label holder



1-line
Plain
Material: PVC
Colour: White
Self-adhesive

Art. No.

238271



2-line
Plain
Material: PVC
Colour: White
Self-adhesive

Art. No.

238272



3-line
Plain
Material: PVC
Colour: White
Self-adhesive

Art. No.

238273

Closing part



8602C3-733-B
for closing unused holes in cover, Ø 30.5 mm, NBR

Art. No.

244306

8602C3-733-S
for closing unused holes in cover, Ø 30.5 mm, silicone

Art. No.









244307

Spare Parts

Label holder

Art. No.

8602C3-008-B-M01-02-MS02

	Size 2, without insert disc, 1- or 2-line label for actuators Ø 39	223567
	Size 3, without insert disc, 1-, 2- or 3-line label for actuators Ø 39	223568
Special key		Art. No.
	for tightening plastic locking nut	169101
Pressure plates		Art. No.
	for key-operated switch and axial rotary actuator 1 to 2 contact elements	253627
	for key-operated switch and axial rotary actuator 3 to 4 contact elements	221707
Holder for front installation		Art. No.
	8602/3 holder for cable duct	248673
Adaptor for front installation		Art. No.
	8602/3 Front installation for indicator lamp series 8010/6 and contact element series 8082/3	227038
8082/3 Contact element		Art. No.
	for NC contact front installation	240898
	for NO contact front installation	240899

We reserve the right to make alterations to the technical data, dimensions, weights, designs and products available without notice. The illustrations cannot be considered binding.