

Installation Equipment

Mushroom stay-put button With key

EM-STOP

8602C3-009-B .. MS2



- Pushbutton, mushroom pushbutton, mushroom stay-put button with key lock, mushroom stay-put button, twin pushbutton and illuminated pushbutton, rotary actuator, key-operated switch, potentiometer bezel and indicator lamp bezel
- One axial actuator can actuate up to four 8082 series contact elements
- Key-operated switches and rotary switches codable at any time as "latching/spring return" or "key not removable"

WebCode **8602A**



Thanks to their special technical features, the actuators from the 8602/3 series can withstand the most extreme conditions. In addition to the application option for use in ambient temperatures from -60 °C to +70 °C, the IP degree of protection, IP66, is maintained in accordance with EN 60529. It is also possible to actuate up to four contact elements from the 8082 series with a single axial actuator from the 8602/3 series.

The coding option of the key switches and rotary switches is innovative and one-of-a-kind. Integrated coding allows you to adjust the "latching/spring return" and/or "key not removable" functions at any time without additional accessories. A versatile set of accessories consisting of label holders and locking devices is available.

Technical Data

Explosion Protection

Application range (zones)	1 2 21 22
IECEX gas certificate	IECEX PTB 13.0047U
IECEX gas explosion protection	Ex eb IIC Gb
IECEX dust certificate	IECEX PTB 13.0047 U
IECEX dust explosion protection	Ex tb IIIC Db
ATEX gas certificate	PTB 13 ATEX 1019 U
ATEX gas explosion protection	Ex II 2 G Ex eb IIC Gb
ATEX dust certificate	PTB 13 ATEX 1019 U
ATEX dust explosion protection	Ex II 2 D Ex tb IIIC Db
UL gas certificate	E182378 V4 S2
Certificates	ATEX (PTB), Brazil (ULB), Canada / USA (UL), EAC (CCVE), IECEX (PTB), India (PESO), Korea (KGS)

Functional Safety

SIL-capable	only with contact elements 8082/1, 8082/2, 8208/24-15
-------------	---

Ambient Conditions

Ambient temperature	-20 °C ... +60 °C
Ambient temperature	-4 °F ... +140 °F
Storage temperature	-25 °C ... +60 °C
Storage temperature	-13 °F ... +140 °F
Use at the height of	< 2000 m

Installation Equipment

Mushroom stay-put button With key

EM-STOP

8602C3-009-B .. MS2



Ambient Conditions

Degree of contamination	3
-------------------------	---

Mechanical Data

Version	with key lock
Degree of protection (IP)	IP66
Note on degree of protection	According to IEC/EN 60529
Enclosure material	Polyamide
Silicone-free	Yes
Assembly	009
Diameter	39 mm
Service life, min.	10 ⁵ actuations
Impact strength (IEC 60079)	7 J
Impact strength (IEC 62262)	min. IK08
Colour	Yellow/red
Fastening	Thread type
Designation plate	With yellow backing plate
Seal	Standard
Closing	MS2
Weight	0.75 kg
Weight	1.65 lb
Decription note	2 keys enclosed.

Mounting / Installation

Tightening torque	3 Nm
Tightening torque lbf in	26.55 lbf in

Dimensional Drawings (All Dimensions in mm [inches]) – Subject to Alterations

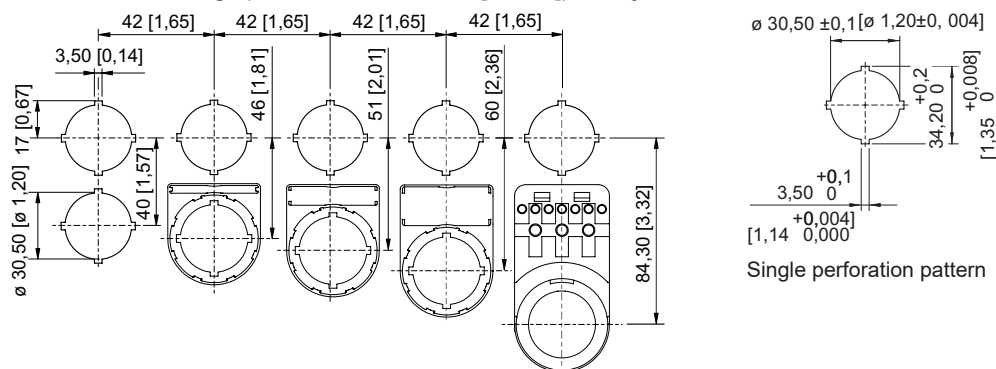

Standard cut-out with / without front label

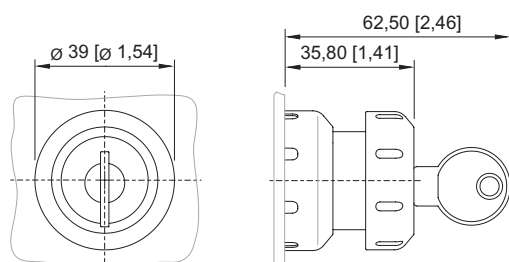

8602/3-006 Mushroom stay-put button with key lock red / black
 8602/3-009 Mushroom stay-put button with key lock red / yellow
 Actuator with axial actuation

Installation Equipment

Mushroom stay-put button With key

EM-STOP

8602C3-009-B .. MS2



Accessories



Spare key

	Closing MS2	Art. No. 272645
--	-------------	--------------------

Label holder

	Size 1, without insert disc, 1-line label for actuators Ø 39	Art. No. 223566
--	---	--------------------

Insert discs for label holder

	1-line Plain Material: PVC Colour: White Self-adhesive	Art. No. 238271
	2-line Plain Material: PVC Colour: White Self-adhesive	Art. No. 238272
	3-line Plain Material: PVC Colour: White Self-adhesive	Art. No. 238273

Label, yellow, general

	for Ø 39 actuator (EM-STOP)	Art. No. 223571
--	-----------------------------	--------------------

Closing part

	8602C3-733-B for closing unused holes in cover, Ø 30.5 mm, NBR	Art. No. 244306
	8602C3-733-S for closing unused holes in cover, Ø 30.5 mm, silicone	Art. No. 244307

Spare Parts

Protective collar

	8602C3-751 plastic/red for mushroom stay-put button with key lock/mushroom stay-put button Ø 39 BG006, BG009, BG010, BG012	Art. No. 257707
--	--	--------------------









Installation Equipment

Mushroom stay-put button With key

EM-STOP

8602C3-009-B .. MS2



	8602C3-751 plastic/yellow for mushroom stay-put button with key lock/mushroom stay-put button Ø 39 BG006, BG009, BG010, BG012	257708
Label holder		Art. No.
	Size 2, without insert disc, 1- or 2-line label for actuators Ø 39	223567
	Size 3, without insert disc, 1-, 2- or 3-line label for actuators Ø 39	223568
Special key		Art. No.
	for tightening plastic locking nut	169101
Pressure plates		Art. No.
	Ø 37 mm 3 contact elements	215436
	Ø 48.5 mm 4 contact elements	215437
Holder for front installation		Art. No.
	8602/3 holder for cable duct	248673
Adaptor for front installation		Art. No.
	8602/3 Front installation for indicator lamp series 8010/6 and contact element series 8082/3	227038
8082/3 Contact element		Art. No.
	for NC contact front installation	240898
	for NO contact front installation	240899

We reserve the right to make alterations to the technical data, dimensions, weights, designs and products available without notice. The illustrations cannot be considered binding.