

Camera and Video systems

Pan-tilt-zoom IP camera and illuminator



EC-951-V6C02L8R2T0M000 Art. No. 296136



- PTZ camera with additional IR illuminator for object detection at night
- With "dynamic masking" for anonymisation of staff and objects
- Full HD, low-light technology, ONVIF Q, S, T, electronic image stabilisation, and direct fibre optic connection
- Extremely fast rotating, extremely precise and up to 218 pre-sets
- Ambient temperature -40° ... +65 °C
- Certified for hazardous areas Zone 1, 2, 21, 22, according to ATEX, ATEX, IECEx, NEC / CEC, Lloyd's

MY R. STAHL EC951A



ONVIF 000



The EC-951 PTZ camera version is an extended version of the EC-941 camera and comes with an additional IR illuminator. The camera provides excellent object detection in dark or low-light situations at a range of up to 200 m.

All cameras come with the „dynamic masking“ feature to anonymise video data of faces so that are no longer identifiable according to relevant privacy regulations.

Technical Data

Explosion Protection

Application range (zones)	1 2 21 22
IECEx gas certificate	ULD 16.0005X
IECEx gas explosion protection	Ex db IIC T6...T4 Gb
IECEx dust certificate	ULD 16.0005X
IECEx dust explosion protection	Ex tb IIIC T85°C...T135°C Db
ATEX gas certificate	16 ATEX 1674X
ATEX gas explosion protection	Ex II 2 G Ex db IIC T6...T4 Gb
ATEX dust certificate	16 ATEX 1674X
ATEX dust explosion protection	Ex II 2 D Ex tb IIIC T85°C...T135
cULus certificate	E482740
Lloyd's Register categories	ENV1, ENV2, ENV3, ENV5

Electrical Data

Rated operational voltage AC	100 V
Rated operational voltage DC	
Rated operational current AC	1.2 A
Power consumption	120 W
Interfaces	SFP port & RJ45 socket
Connection	10/100Base-T, 100Base FX
I/O alarm	1x alarm input
I/O relay	2x relay output

Camera Data

Sensor	1/2.8" Exmor R CMOS
Lens	f = 4.3 (w) to 129 mm (t) From F1.6 to F14

Camera and Video systems

Pan-tilt-zoom IP camera and illuminator



EC-951-V6C02L8R2T0M000 Art. No. 296136

Camera Data

Viewing angle	63.7° to 2.3° H, 38.5° to 1.3° V
Focus	Auto, manual, trigger
Zoom	30x (360x digital zoom)
Resolution	Full HD 1080p 1920x1080 pixels
Pixel	2.13 megapixels
Number of preset positions	Up to 250
Accuracy of preset positions	0.02 °
Horizontal speed (variable)	0,1°/s ... 100°/s
Vertical speed (variable)	0,1°/s ... 100°/s
Frame rate (fps)	1 to 60 frames per second
Back light compensation	On/Off
Compression	H.264, MJPEG, JPEG, MPEG4
No. of privacy maskings	24 (8 simultaneously)
De-fog	Off/Low/Mid/High
WDR (dynamic range)	120 dB
White balance	AWB, ATW, internal, external (Fixed, auto), sodium vapour lamp (Fixed, auto, external auto)
Wide Dynamik Range	On/Off Light level, selection of Brightness compensation Light compensation level
Motion detection	Yes
Web server	Yes

Software

Network protocol	ONVIF profiles Q,S,T
Network Configuration	TCP/IPv4-IPv6, UDP/IPv4-IPv6, HTTP, HTTPS, NTP, DHCP, WS-DISCOVERY, DSCP, IGMP (Multicast), SOAP, DNS, SNMP
Streaming	RTSP, RTCP, RTP/IPv4, HTTP Multicast

Ambient Conditions

Cold start range (with heating)	-40°C up to -10°C
---------------------------------	-------------------

Mechanical Data

Version	Low light camera + illuminator
Degree of protection (IP)	IP66, 67, 68, 69
Enclosure material	Stainless steel 316L
Cable length	0 m
Opening for cable gland	2 x 3/4" NPT
Slewing range	360° continuous
Tilt range	-90° ... +90°
Integrated wiper	Yes
Package weight	35 kg
Package dimensions	540 x 310 x 490 mm
Weight	31 kg
Weight	68.34 lb

EC-951-V6C02L8R2T0M000 Art. No. 296136

Dimensional Drawings (All Dimensions in mm [inches]) – Subject to Alterations

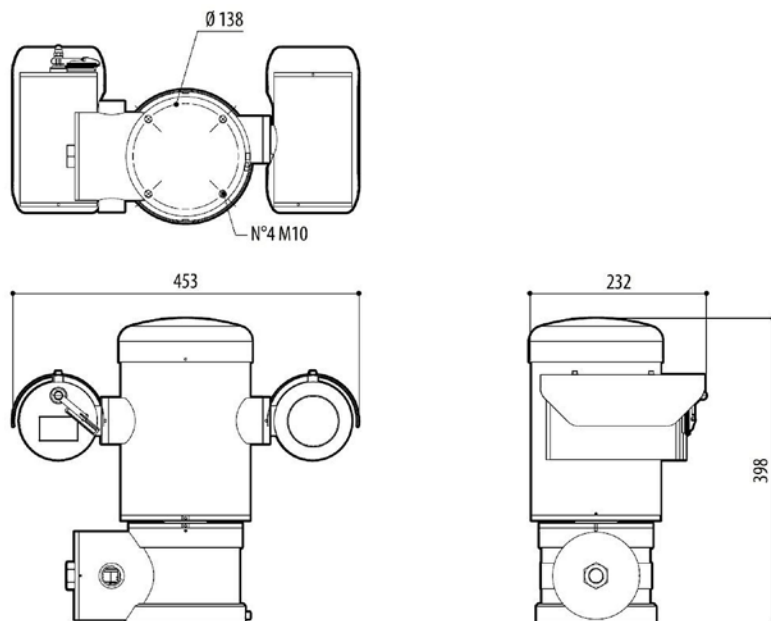

Accessories

Camera multi-cable armoured

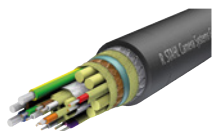

VB-CAM-MULTI-Ethernet-ARM

1 x Ethernet cable
3 x power supplies 2.5 mm²
7 x data cable 0.34 mm²
-60 °C ... +80 °C
19.2 ±0.5 mm outer diameter
IEC 60332-1 flame-resistant
IEC 60754-2 halogen-free
DIN 60811-404 oil-resistant
NEK 606 mud-resistant
Price per metre

Art. No.

252571

EC-951-V6C02L8R2T0M000 Art. No. 296136

Ex e Terminal box

Art. No.

	<p>JCT-8146-Ethernet+Analog 5xcable glands Terminal box, polyester resin Version for ethernet Tx or analog cameras Dimensions without cable glands (HxWxD): 340.5 mm x 340.5 mm x 91 mm Ingress protection: IP66 equipped with: 5 x cable glands: 2 x CMP-25SC2KVAR KLE MsNi M25x1.5 1 x 8161/7-M25-1707 with red stopping plug 2 x 8161/7-M20-1304 with red stopping plug usable for: EC-750, EC-910-AFZ, EC-940S-AFZ (ATEX, IECEx) EC-840S-TIC (ATEX, IECEx), EC-94x-PTZ, Water tank</p>	<p>265668</p>
	<p>JCT-8146-22P-FO-BOX-4xM20-1xM25-R1.1 Terminal box, polyester resin Version for ethernet Tx and Fx, IP cameras Dimensions (HxWxD): 340.5 mm x 340.5 mm x 91 mm screwed lid Protection class: IP 66 Including TAG label (Formica) equipped with: 01x Telegärtner mounting rail distributor (6x SC Duplex) 20x Phoenix terminal block UT 2.5 02x Phoenix protective conductor terminal USLKG5 Cable entries: 01x brass plate 01x CMP 20sA2F M20, MsNi 01x CMP 20s16A2F M20, MsNi 02x M20 sealing plugs, nickel-plated brass (enclosed) 02x CMP 20sC2K M20, MsNi 01x CMP 25SC2KVAR M25, MsNi usable for: EC-941-PTZ</p>	<p>286343</p>

Wall bracket

Art. No.

	<p>WB-EC-940-PTZ/EC-941 Wall bracket for EC-940-PTZ and EC-941 Material: 316L (1.4404) stainless steel, electropolished Load capacity: max. 40 kg Length: 400 mm</p>	<p>251364</p>
--	---	---------------

Pole mounting

Art. No.

	<p>PMA-EC-940-PTZ/EC-941 Pole mount adaptor for EC-940-PTZ and EC-941 Material: 316L (1.4404) stainless steel, electropolished For pole diameter 110 ... 150 mm Load capacity: max. 50 kg Only together with wall bracket WB-EC-940-PTZ/EC-941</p>	<p>251362</p>
--	---	---------------

EC-951-V6C02L8R2T0M000 Art. No. 296136

Corner adapter module

Art. No.

	<p>CMA-EC-940-PTZ/EC-941 Corner adapter module EC-940-PTZ and EC-941 Material: 316L (1.4404) stainless steel, electropolished Capacity: max. 50 kg WxH: 335 x 186 mm Only together with wall bracket WB-EC-940-PTZ/EC-941</p>	<p>251363</p>
--	--	---------------

Parapet mounting bracket

Art. No.

	<p>PB-EC-940-PTZ/EC-941 Parapet mounting bracket for EC-940-PTZ and EC-941 Material: 316L (1.4404) stainless steel, electropolished Load capacity: max. 40 kg Diameter: 238 mm</p>	<p>251365</p>
--	---	---------------

Power line filter

Art. No.

	<p>EMC filter TDK, 1phase, 250VAC, 6A EPCOS / TDK B84112G0000B060 Mandatory for use of cameras in maritime applications Filter Type: EMC Power Line Filter Voltage Rating: 250 V Current Rating: 6 A Mounting Style: Chassis Mount Termination Style: Tab Connector Leakage Current: 0.369 mA Operating Frequency: 50 Hz / 60 Hz Construction 2-line filter Metal case Polyurethane potting (UL 94 V-0) ENEC, UL and cUL approval</p>	<p>279754</p>
--	--	---------------

Water tank

Art. No.

	<p>WaterTank 10-PV-A 316L (1.4404) stainless-steel enclosure, electropolished Capacity 10 litres Pressure generation by manual pumping or with compressed air Pressure: max 6 bar 24 V AC/DC, max 20 W Temp. range -40 °C to +60 °C (depending on freezing point of liquid used) ATEX certified Zone 1, 2 Suitable for EC-94x-PTZ and EC-940S-AFZ</p>	<p>251366</p>
--	--	---------------

Cable glands

Art. No.

	<p>CMP-20s16PXSS2K-REX KLE MsNi 3/4" OR Metal cable gland explosion protected for unarmoured cable Clamping range: 3.1 ... 8.6 mm Potting compound 250599 CMP-RAPIDEX30 is additionally required</p>	<p>282717</p>
	<p>CMP-20sPXSS2K-REX KLE MsNi 3/4" OR Metal cable gland explosion protected for unarmoured cable Clamping range: 6.1 ... 11.7 mm Potting compound 250599 CMP-RAPIDEX30 is additionally required</p>	<p>282687</p>

EC-951-V6C02L8R2T0M000 Art. No. 296136

	<p>CMP-25sPX2K-REX KLE MsNi NPT 3/4" Metal cable gland explosion protected for armoured cable (usable for cable 252571 VB-CAM-MULTI-Ethernet-ARM) Clamping range: 14 ... 22 mm Potting compound 250599 CMP-RAPIDEX30 is additionally required</p>	<p>251734</p>
--	---	---------------

SFP Module

Art. No.

	<p>SFP Moxa SFP-1FEMLC-T Can be used in camera EC-941 Transmission: multi-mode Power consumption: max. 1 W Bandwidth: 100Base-FX / 100MBit/s Wavelength: 1310 nm Connector: LC duplex Distance: 2 km / 4 km Temperature range: -40 ° C ... + 85 ° C</p>	<p>282714</p>
	<p>SFP Barox AC-SFP-FXMME 100MB MM T Can be used in Barox Switch in safe areas, not useable in camera EC-941 Transmission: multi-mode Bandwidth: 100Base-FX / 100MBit/s Wavelength: 1310 nm Connector: LC duplex Distance: 2 km Temperature range: -40 ° C ... + 85 ° C</p>	<p>276421</p>

Spare Parts

Potting compound

Art. No.

	<p>CMP-RAPIDEX30 Potting compound for cable glands</p>	<p>250599</p>
--	--	---------------

We reserve the right to make alterations to the technical data, dimensions, weights, designs and products available without notice. The illustrations cannot be considered binding.