

Control Devices

Control device for panel mounting

Ex e

8003/113-001-6 UL Art. No. 213516



- Flexible configuration due to pushbutton, mushroom push-button, mushroom stay-put button, mushroom stay-put button with key lock, key-operated button, key-operated switch
- Easy assembly thanks to single-hole mounting (D 30)
- Codable "latching", "spring return", "key not removable" functions
- Plug-in connection with 6 m connection line

MY R. STAHL 8003D



R. STAHL Series 8003 control buttons and/or switches for panel mounting switch load, control and signal circuits up to 6 A. Depending on the type, they are complete or incomplete explosion-protected equipment with corresponding requirements for installation. As an option, various actuators are available.

Technical Data

Explosion Protection

Scope of validity	European Union (ATEX) CEC IECEX NEC
Application range (zones)	1 2 21 22
IECEX gas certificate	IECEX PTB 06.0065X
IECEX gas explosion protection	Ex db eb IIC T6 Gb
IECEX dust certificate	IECEX PTB 06.0065X
IECEX dust explosion protection	Ex tb IIIC T80 °C Db
ATEX gas certificate	PTB 02 ATEX 1057 X
ATEX gas explosion protection	⊕ II 2 G Ex db eb IIC T6 Gb
ATEX dust certificate	PTB 02 ATEX 1057 X
ATEX dust explosion protection	⊕ II 2 D Ex tb IIIC T80 °C Db
Certificates	ATEX (PTB), Canada (UL), IECEX (PTB), Korea (KGS), USA (UL)
Declaration of Conformity	ATEX (EUK), ATEX (Simple apparatus), China (CCC), Declaration of Conformity (ATEX)
Notes	Product label may vary. Series devices have certification according to ATEX, IECEX, NEC® and CE Code.

Electrical Data

Rated operational voltage AC	500 V
Rated operational current	6 A
Switching capacity AC-12	500 V / 6 A / max. 3000 VA
Switching capacity AC-15	400 V / 6 A / max. 1250 VA
Switching capacity DC-13	110 V / 1 A / max. 110 W
Switching capacity DC-13<SoftReturn/>2 contact elements in series	60 V/6 A

Control Devices

Control device for panel mounting

Ex e

8003/113-001-6 UL Art. No. 213516



Ambient Conditions

Ambient temperature	-20 °C ... +60 °C
Ambient temperature	-4 °F ... +140 °F
Ambient temperature NEC®	-30 °C ... +60 °C
Ambient temperature NEC®	-22 °F ... +140 °F

Mechanical Data

Degree of protection (IP) (IEC 60529)	Reverse side IP65, front side IP66
Enclosure material	Polyamide
Contact material	Silver-nickel
Silicone-free	Yes
Number of NCs	1
Number of NOs	1
Conductor length	6 m
Conductor length, inches	236.22 in
Connection cross-section	0.75 ... 1.5 mm ²
Connection cross-section AWG	20 AWG ... 14 AWG
Type of connection cable	ÖLFLEX 4x1 mm ²
Depth of cut-out	130 mm
Mounting depth, inches	5.12 in
Service life, min.	10 ⁵ operating cycles
Weight	125 g
Weight	0.28 lb

Mounting / Installation

Tightening torque	3 Nm
Tightening torque lbf in	26.55 lbf in

Components

Actuator	Pushbutton
Entry 1	8161/7-M16-0902
Entry 1 type	Polyamide cable gland, black

Technical Drawings – Subject to Alterations

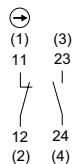

Schematic 8003/113
NO / NC positive opening
Numbers in brackets according to core identification

Dimensional Drawings (All Dimensions in mm [inches]) – Subject to Alterations

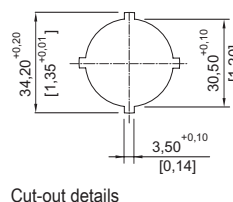
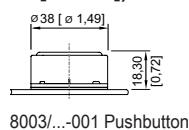
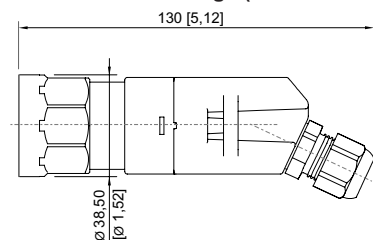

Control Devices

Control device for panel mounting

Ex e

8003/113-001-6 UL Art. No. 213516

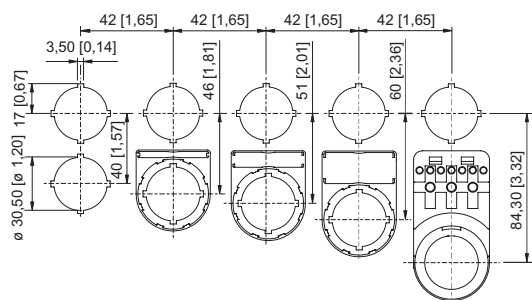

Cut-out with/without additional designation plate

Accessories

Actuator



Pushbutton

Art. No.

155525

Locking devices



8602A0753 H24 for not actuated pushbutton/selector switch
BG001, BG005

Art. No.

155372



8602A0754 for actuated pushbutton/selector switch
BG001, BG005

155402



8602A0755 for not actuated pushbutton/selector switch
BG001, BG005

155431

Protective collar



8602A0751 metal
for pushbutton/selector switch/mushroom stay-put button with key lock/mushroom stay-put
button/mushroom pushbutton dia. 39
BG001, BG003, BG005, BG008, BG009, BG010, BG012

Art. No.

155326

Spare Parts

Label mount



Label mount, size 1, without symbol label
Text: 1 line
for actuators to fit Ø 30.5 mm holes

Art. No.

155632



Label mount, size 2, without symbol label
Text: 1 or 2 lines
for actuators to fit Ø 30.5 mm holes

155687

Control Devices



Control device for panel mounting

Ex e

8003/113-001-6 UL Art. No. 213516

STAHL

	Label mount, size 3, without symbol label Text: 1, 2 or 3 lines for actuators to fit Ø 30.5 mm holes	155844
--	--	--------

Symbol label for pushbutton and selector switch	Art. No.	
	Colour: blue Please specify text or symbol	155910
	Colour: green Please specify text or symbol	155900
	Colour: white Text: START	155889
	Colour: blue Text: RESET	155894
	Colour: green Text: START	155721
	Colour: black Text: Ab	155886
	Colour: black Text: Auf	155883
	Colour: black Symbol: Arrow	155749
	Colour: black Symbol: Arrow	155761
	Colour: black Text: Links	155827







Control Devices

Control device for panel mounting

Ex e

8003/113-001-6 UL Art. No. 213516



	Colour: black Text: Rechts	155837
	Colour: black Text: Open	155868
	Colour: black Text: CLOSE	155878
	Colour: black Text: Zu	155874
	Colour: red Text: OFF	155654
	Colour: green Text: ON	155671

Insert discs for label holder

Art. No.

	One-line Plain Material: PVC Colour: White Self-adhesive	238271
--	--	--------

Symbol label for pushbutton and selector switch

Art. No.

	Colour: red Text: AUS	155634
--	--------------------------	--------

Insert discs for label holder

Art. No.

	Two-line Plain Material: PVC Colour: White Self-adhesive	238272
--	--	--------

Symbol label for pushbutton and selector switch

Art. No.

	Colour: black Text: AUS	155806
--	----------------------------	--------

Control Devices

Control device for panel mounting

Ex e

8003/113-001-6 UL Art. No. 213516







Insert discs for label holder

Art. No.

	Three-line Plain Material: PVC Colour: White Self-adhesive	238273
--	--	--------

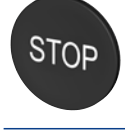
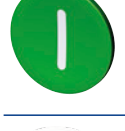
Symbol label for pushbutton and selector switch

Art. No.

	Colour: black Text: EIN	155862
	Colour: red Text: STOP	155615
	Colour: black Text: STOP	155795
	Colour: black Text: I	155846
	Colour: green Text: I	155689
	Colour: white Text: I	155892
	Colour: black Text: II	155854
	Colour: green Text: II	155706
	Colour: red Text: O	155596
	Colour: black Text: O	155783

Control Devices

Control device for panel mounting

Ex e

8003/113-001-6 UL Art. No. 213516



	Colour: black Text: I O	155771
	Colour: blue Blank label without text	155911
	Colour: yellow Blank label without text	155914
	Colour: red Blank label without text	155897
	Colour: green Blank label without text	155901
	Colour: white Blank label without text	155908
	Colour: black Blank label without text	155905

We reserve the right to make alterations to the technical data, dimensions, weights, designs and products available without notice. The illustrations cannot be considered binding.