

8562/53-5045-320 Art. No. 214888



- Non-adjustable thermal and magnetic releases
- Isolating function in accordance with EN 60947-2
- Energy limiting class 3

MY R. STAHL 8562B



R. STAHL Series 8562 miniature circuit breakers boast good current limiting for short circuits and a high switching capacity of 6 or 10 kA. This results in a low load on conductors and a high selectivity for upstream fuses. The components have a modular design and are therefore available in 1- to 4-pole versions and for nominal currents from 0.5 to 40 A.

Technical Data

Explosion Protection

Application range (zones)	1, 2
IECEX gas explosion protection	Ex de IIC T5 Gb
IECEX firedamp protection	Ex de I Mb
ATEX gas explosion protection	⊕ II 2 G Ex de IIC T5 Gb
ATEX firedamp protection	⊕ I M2 Ex de I Mb
Certificates	ATEX (PTB), Brazil (ULB), IECEX (PTB)

Electrical Data

Type of voltage	AC
AC rated operational voltage	230 V
Rated operational current	32 A
Rated operational current	32 A
Rated switching capacity	10 kA
Auxiliary contacts	1 change-over contact
No. of poles	2
N-pole present	Yes
Tripping characteristic	C

Ambient Conditions

Ambient temperature	-20 °C ... 60 °C
---------------------	------------------

Mechanical Data

Degree of protection (IP)	IP20
Enclosure material	Epoxy resin
Width	72 mm
Width	72 mm
Width, inches	2.83 in
Length	156 mm
Length in inches	6.14 in
Mounting depth	117 mm

8562/53-5045-320 Art. No. 214888

Mechanical Data

Mounting depth in inches	4.61 in
Weight	1.5 kg
Weight	3.31 lb

Technical Drawings – Subject to Alterations

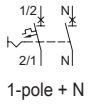

Fault signal contact 1 change-over contact for error signal
(only for types 8562/54-2465-160-4 and 8562/54-2475-4: After the switch trips, the fault message contact can be reset manually)

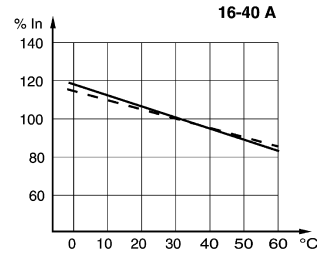

Correction factors for ambient temperatures which deviate from 30 °C

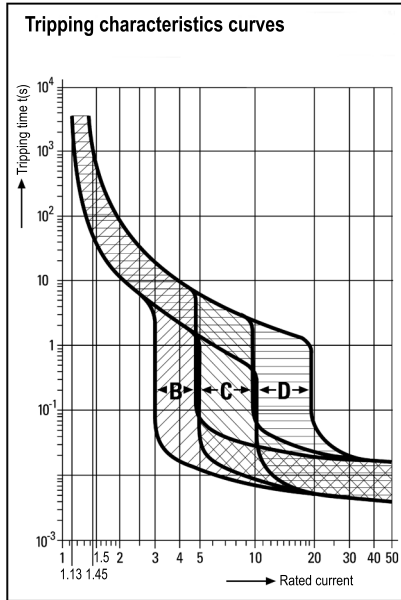

Dimensional Drawings (All Dimensions in mm [inches]) – Subject to Alterations

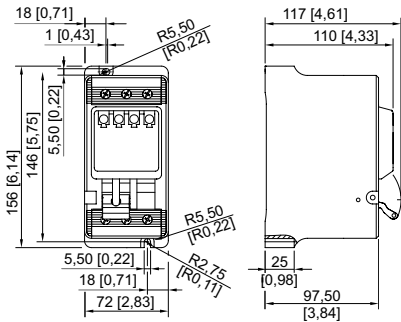

8562/53

We reserve the right to make alterations to the technical data, dimensions, weights, designs and products available without notice. The illustrations cannot be considered binding.