

Isolators

Transmitter supply unit

Ex i field circuit

9160/13-11-11k Art. No. 214896



- Can be used universally for 2- and 3-wire transmitters and mA sources (4-wire transmitters)
- High accuracy
- For use up to SIL 2, special variant up to SIL 3 (IEC/EN 61508)

MY R. STAHL 9160A



Series 9160 Ex i transmitter supply units are used for the intrinsically safe operation of 2- and 3-wire transmitters or intrinsically safe mA sources such as 4-wire transmitters. The device transmits HART signals in both directions. The range includes one- and two-channel devices, as well as a variant for signal duplication. Special versions are available for lower output voltages and SIL 3.

Technical Data

Explosion Protection

Application range (zones)	2
Ex interface zone	0 1 2 20 21 22
IECEX gas certificate	IECEX BVS 08.0050 X
IECEX gas explosion protection	Ex nA nC [ja Ga] IIC T4 Gc
IECEX dust certificate	IECEX BVS 08.0050 X
IECEX dust explosion protection	[Ex ia Da] IIIC
IECEX firedamp certificate	IECEX BVS 08.0050 X
IECEX firedamp protection	[Ex ia Ma] I
ATEX gas certificate	DMT 03 ATEX E 010 X
ATEX gas explosion protection	⊕ II 3 (1) G Ex nA nC [ja Ga] IIC T4 Gc
ATEX dust certificate	DMT 03 ATEX E 010 X
ATEX dust explosion protection	⊕ II (1) D [Ex ia Da] IIIC
ATEX firedamp certificate	DMT 03 ATEX E 010 X
ATEX firedamp protection	⊕ I (M1) [Ex ia Ma] I
FMus certificate	FM16US0122X
cFM certificate	FM16CA0067X
Marking cFMus	Class I, Div. 2, Groups A,B,C,D; Class I, Zone 2, nA nC Group IIC AIS Class I,II,III, Div. 1, Groups A,B,C,D,E,F,G; Class I, Zone 0, [Ex ia] IIC T4 Mounting vert. at Ta = 70°C , or horizontal Ta = 60°C See Doc. 91 606 01 31 1

Explosion Protection

Certificates	ATEX (BVS), Brazil (ULB), Canada (FM), China (NEPSI), IECEx (BVS), Korea (KTL), SIL (exida), USA (FM)
Ship approval	CCS, EU RO MR (DNV)
Declaration of Conformity	ATEX (EUK), China (CCC)

Safety Data

Max. voltage U_o	27 V				
Max. current I_o	88 mA				
Max. power P_o	576 mW				
Max. permissible external capacity C_o for I	3750 nF				
Max. permissible external inductance L_o for I	40 mH				
Max. permissible external capacity C_o for IIC	0.09 μ F				
Max. permissible external capacity C_o for IIB	0.705 μ F				
Max. permissible external capa.IIA	2330 nF				
Max. permissible external inductance L_o for IIC	2.3 mH				
Max. permissible external inductance L_o for IIB	17 mH				
Max. permissible external inductance L_o for IIA	28 mH				
Max. voltage U_i	30 V				
Max. voltage U_o isolation amplifier	4.1 V				
Max. current I_i note	Internally limited				
Max. power P_i	100 mW				
Internal capacitance	Negligible				
Internal capacitance isolation amplifier	Negligible				
Internal inductance	Negligible				
Internal inductance L_i isolation amplifier	Negligible				
Safety-related max. voltage	253 V AC				
Intrinsically safe limiting values inductance L_o /capacitance C_o	Jointly connectable inductance L_o /capacitance C_o				
IIC	L_o [mH]	2 mH	1 mH	0.500 mH	0.200 mH
	C_o [μ F]	0.042 μ F	0.056 μ F	0.072 μ F	0.090 μ F
IIB	L_o [mH]	17 mH	2 mH	0.500 mH	0.200 mH
	C_o [μ F]	0.290 μ F	0.320 μ F	0.460 μ F	0.600 μ F
IIA	L_o [mH]	28.000 mH	2.000 mH	1.000 mH	0.200 mH
	C_o [μ F]	0.410 μ F	0.320 μ F	0.540 μ F	0.820 μ F
IIIC	L_o [mH]	17.000 mH	2.000 mH	0.500 mH	0.200 mH
	C_o [μ F]	0.290 μ F	0.320 μ F	0.460 μ F	0.600 μ F
I	L_o [mH]	40.000 mH	20.000 mH	0.500 mH	0.100 mH
	C_o [μ F]	0.480 μ F	0.660 μ F	0.810 μ F	1.200 μ F

Functional Safety

SIL	2
-----	---

Functional Safety

HFT	0
SFF	85%
Lambda SD	0 FIT
Lambda SU	0 FIT
Lambda DD	163 FIT
Lambda DU	28 FIT
PFD _{avg} at T _{proof} 1 year	2,29E-04
PFD _{avg} at T _{proof} 2 years	3,38E-04
PFD _{avg} at T _{proof} 5 years	6,64E-04

Electrical Data

Number of channels	1
Measuring transformer feed operation	Yes
Isolation amplifier operation	Yes
LFD relay	Yes
Communication signal	HART, 0.5 to 10 kHz

Auxiliary Power

Auxiliary power	24 V DC
Auxiliary power nominal voltage	24 V DC
Auxiliary power voltage range	18 to 31.2 V
Voltage range residual ripple	≤ 3,6 V _{SS}
Nominal current	88 mA
Auxiliary power max. power dissipation	1.7 W
Power consumption	2.1 W
Polarity reversal protection	Yes
Undervoltage monitoring	Yes
Operation indication	Green "PWR" LED

Galvanic Isolation

Test voltage as per standard	IEC EN 60079-11
Ex i input to output	1.5 kV AC
Ex i input to auxiliary power	1.5 kV AC
Ex i input to fault message contact	1.5 kV AC
Test voltage as per standard	EN 50178
Output to auxiliary power	350 V AC
Galvanic separation FMC to HE and output	350 V AC

Input

Input function	Isolation amplifier Transmitter power unit
Input	0/4 ... 20 mA with HART
Input signal	0/4 to 20 mA with HART
Function range input	0 ... 24 mA
Max. input current, mA sources	50 mA
Input for open-circuit voltage U _a	≤ 26 V
Short-circuit current	≤ 35 mA
Supply voltage for transmitter	≥ 16 V at 20 mA

Input	
Input resistance	≤ 100 ohm
Output	
Output	0/4 to 20 mA with HART
Output signal	0/4 to 20 mA with HART
Function range output	0 – 24 mA
Output A	0/4 to 20 mA
Output current at I _e =0	0 mA
Max. load resistance R _L HART	379 Ω
Max R _L load with resistor	379 Ω
Max. load resistance R _L	600 Ω
Max R _L note	With internal 221 ohm resistor
Output residual ripple	≤ 40 μA _{eff}
Settling time 10-90%	≤ 100 μs
Temperature influence error limits	≤ 0.05% / 10 K
Fault message contact switching capacity	30 V / 100 mA
LF switch user adjustment	Activated/deactivated
Indication of line fault	Red "LF" LED
Wire breakage error detection	< 3.6 mA
Short circuit error detection	> 20.5 mA
Wire breakage error detection OFF	< 3,6 mA
Deviation	≤ 0,1 %
Behaviour of the output	= input signal
Behaviour of the output note	Accuracy, typical data expressed as % of calibrated span (20 mA) at U _N , 23 °C
Ambient Conditions	
Ambient temperature	-20 °C ... +70 °C (Single device) -20 °C ... +60 °C (Group assembly)
Ambient temperature	-4 °F ... +158 °F (Single device) -40 °F ... +140 °F (Group assembly)
Storage temperature	-40 °C ... +80 °C
Storage temperature	-40 °F ... +176 °F
Maximum relative humidity	95%
Use at the height of	< 2000 m
Mechanical Data	
Degree of protection (IP)	IP30
Degree of protection (IP) terminals	IP20
Fire resistance (UL 94)	V0
Enclosure material	Polyamide
Grid dimension	17.6 mm
Width	17.6 mm
Width, inches	0.69 in
Height	114.5 mm
Height, inches	4.51 in
Length	128 mm
Length, inches	5.04 in
Mounting depth, inches	4.51 in

Isolators

Transmitter supply unit

Ex i field circuit

9160/13-11-11k Art. No. 214896



Mechanical Data

Weight	195 g
Weight	0.43 lb

Mounting / Installation

Mounting type	DIN rail NS35/15, NS35/7.5
Mounting orientation	Horizontal Vertical
Connection type	Spring clamp terminal
Min. rigid conductor cross section	0.2 mm ²
Max. rigid conductor cross section	2.5 mm ²
Min. flex conductor cross section	0.2 mm ²
Max. flex conductor cross section	2.5 mm ²
Connection cross-section AWG	24 – 14

Technical Drawings – Subject to Alterations

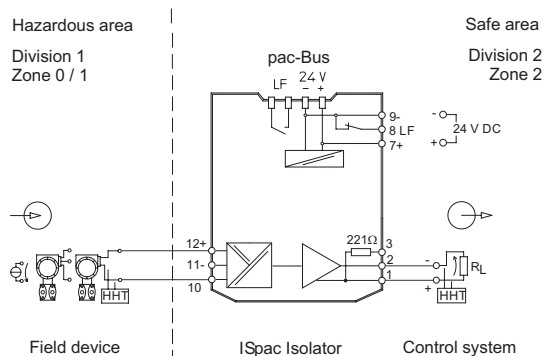

Connection diagram 9160/13-11-11

Dimensional Drawings (All Dimensions in mm [inches]) – Subject to Alterations

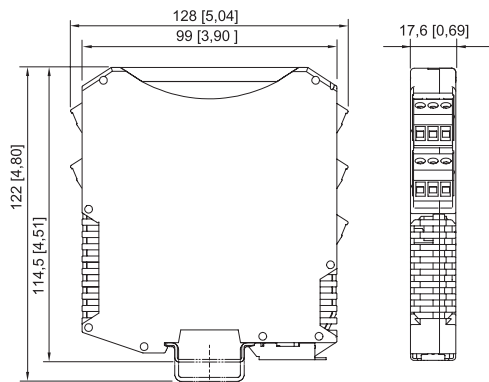

ISpac Series 9146, 9147, 9160, 9162, 9163, 9165, 9167, 9170, 9172, 9175, 9176, 9180, 9182, 9193,
ISbus Series 9412 with spring clamp terminal

Accessories

Transparent cover



For 91xx ISpac modules
Yellow, transparent
Clear identification of the device for SIL applications.
(Packaging unit: 10 pieces)

Art. No.

200914

Isolators

Transmitter supply unit

Ex i field circuit

9160/13-11-11k Art. No. 214896



pac-Bus

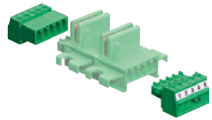

		Art. No.
	Wiring auxiliary power and collective error message	160731

Terminal set for pac-Bus



		Art. No.
	For the supply of 24 V DC auxiliary power via terminals (alternative to using the supply module 9193/21-11-11), with jumper for error message chain for ISpac module 91xx	160730

Spare Parts



Screw terminal

		Art. No.
	3-pole plug, screw connector thread: M3 stripping length: 7 mm colour: green	112817
	3-pole plug, screw connector thread: M3 stripping length: 7 mm colour: black	112816
	3-pole plug, screw connector thread: M3 stripping length: 7 mm colour: blue	112818

Screw terminal with test tap

		Art. No.
	3-pole plug with test tap, screw connector thread: M3 stripping length: 7 mm colour: black	113005
	3-pole plug with test tap, screw connector thread: M3 stripping length: 7 mm colour: blue	113004

Spring clamp terminal

		Art. No.
	3-pole plug with test tap, spring clamp connection stripping length: 10 mm colour: green	112825
	3-pole plug with test tap, spring clamp connection stripping length: 10 mm colour: black	112824
	3-pole plug with test tap, spring clamp connection stripping length: 10 mm colour: blue	112826

Isolators

Transmitter supply unit

Ex i field circuit

9160/13-11-11k Art. No. 214896



We reserve the right to make alterations to the technical data, dimensions, weights, designs and products available without notice. The illustrations cannot be considered binding.