

8562/52-2040-020 Art. No. 214937



- Non-adjustable thermal and magnetic releases
- Isolating function in accordance with EN 60947-2
- Energy limiting class 3

MY R. STAHL 8562B



R. STAHL Series 8562 miniature circuit breakers boast good current limiting for short circuits and a high switching capacity of 6 or 10 kA. This results in a low load on conductors and a high selectivity for upstream fuses. The components have a modular design and are therefore available in 1- to 4-pole versions and for nominal currents from 0.5 to 40 A.

Technical Data

Explosion Protection	
Application range (zones)	1, 2
IECEX gas explosion protection	Ex de IIC T6 Gb
IECEX firedamp protection	Ex de I Mb
ATEX gas explosion protection	Ex II 2 G Ex de IIC T6 Gb
ATEX firedamp protection	Ex I M2 Ex de I Mb
Certificates	ATEX (PTB), Brazil (ULB), IECEX (PTB)
Electrical Data	
Type of voltage	AC/DC
AC rated operational voltage	400 V
DC rated operational voltage	110 V
Rated operational current	2 A
Rated operational current	2 A
Rated switching capacity	10 kA
No. of poles	2
N-pole present	No
Tripping characteristic	C
Ambient Conditions	
Ambient temperature	-20 °C ... 60 °C
Mechanical Data	
Degree of protection (IP)	IP20
Enclosure material	Epoxy resin
Width	54 mm
Width	54 mm
Width, inches	2.13 in
Length	156 mm
Length in inches	6.14 in
Mounting depth	117 mm

8562/52-2040-020 Art. No. 214937

Mechanical Data

Mounting depth in inches	4.61 in
Weight	1.2 kg
Weight	2.65 lb

Technical Drawings – Subject to Alterations

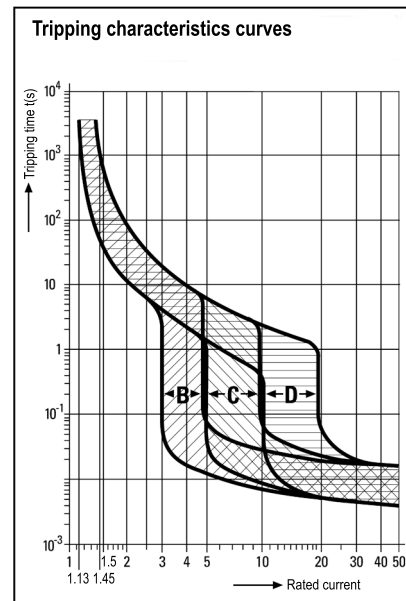
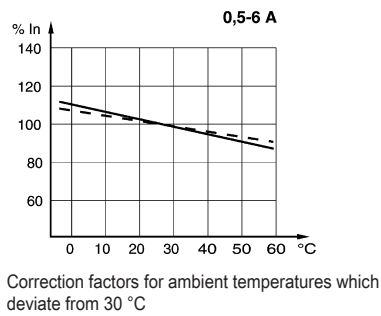
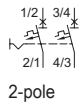

Dimensional Drawings (All Dimensions in mm [inches]) – Subject to Alterations

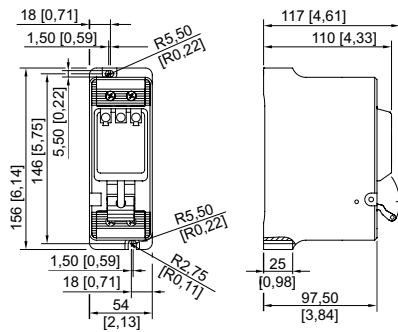

8562/52

We reserve the right to make alterations to the technical data, dimensions, weights, designs and products available without notice. The illustrations cannot be considered binding.