

8562/52-2040-400 Art. No. 214945



- Non-adjustable thermal and magnetic releases
- Isolating function in accordance with EN 60947-2
- Energy limiting class 3

MY R. STAHL 8562B



R. STAHL Series 8562 miniature circuit breakers boast good current limiting for short circuits and a high switching capacity of 6 or 10 kA. This results in a low load on conductors and a high selectivity for upstream fuses. The components have a modular design and are therefore available in 1- to 4-pole versions and for nominal currents from 0.5 to 40 A.

Technical Data

Explosion Protection

Application range (zones)	1, 2
IECEX gas explosion protection	Ex de IIC T4 Gb
IECEX firedamp protection	Ex de I Mb
ATEX gas explosion protection	Ex II 2 G Ex de IIC T4 Gb
ATEX firedamp protection	Ex I M2 Ex de I Mb
Certificates	ATEX (PTB), Brazil (ULB), IECEX (PTB)

Electrical Data

Type of voltage	AC/DC
AC rated operational voltage	400 V
DC rated operational voltage	110 V
Rated operational current	40 A
Rated operational current	40 A
Rated switching capacity	10 kA
No. of poles	2
N-pole present	No
Tripping characteristic	C

Ambient Conditions

Ambient temperature	-20 °C ... 60 °C
---------------------	------------------

Mechanical Data

Degree of protection (IP)	IP20
Enclosure material	Epoxy resin
Width	54 mm
Width	54 mm
Width, inches	2.13 in
Length	156 mm
Length in inches	6.14 in
Mounting depth	117 mm

8562/52-2040-400 Art. No. 214945

Mechanical Data

Mounting depth in inches	4.61 in
Weight	1.2 kg
Weight	2.65 lb

Technical Drawings – Subject to Alterations

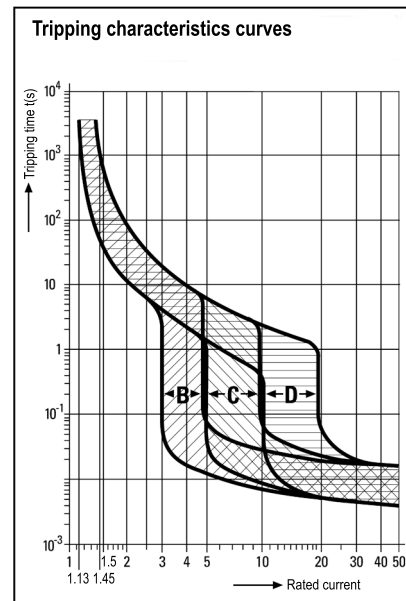
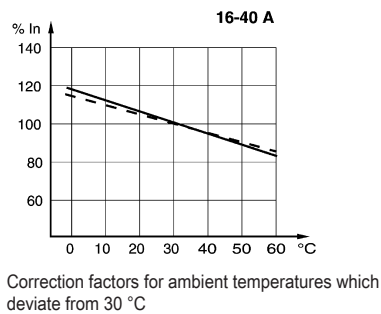
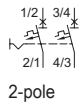

Dimensional Drawings (All Dimensions in mm [inches]) – Subject to Alterations

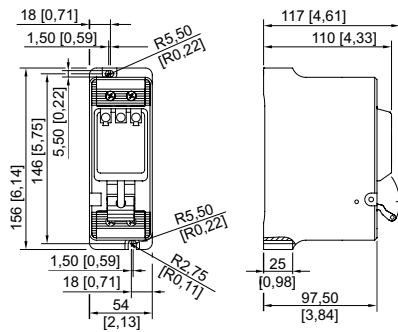

8562/52

We reserve the right to make alterations to the technical data, dimensions, weights, designs and products available without notice. The illustrations cannot be considered binding.