

8562/54-4040-250 Art. No. 215088



- Non-adjustable thermal and magnetic releases
- Isolating function in accordance with EN 60947-2
- Energy limiting class 3

MY R. STAHL 8562B



R. STAHL Series 8562 miniature circuit breakers boast good current limiting for short circuits and a high switching capacity of 6 or 10 kA. This results in a low load on conductors and a high selectivity for upstream fuses. The components have a modular design and are therefore available in 1- to 4-pole versions and for nominal currents from 0.5 to 40 A.

Technical Data

Explosion Protection

Application range (zones)	1, 2
IECEX gas explosion protection	Ex de IIC T6 Gb
IECEX firedamp protection	Ex de I Mb
ATEX gas explosion protection	⊕ II 2 G Ex de IIC T6 Gb
ATEX firedamp protection	⊕ I M2 Ex de I Mb
Certificates	ATEX (PTB), Brazil (ULB), IECEX (PTB)

Electrical Data

Type of voltage	AC
AC rated operational voltage	400 V
Rated operational current	25 A
Rated operational current	25 A
Rated switching capacity	10 kA
No. of poles	4
N-pole present	Yes
Tripping characteristic	C

Ambient Conditions

Ambient temperature	-20 °C ... 60 °C
---------------------	------------------

Mechanical Data

Degree of protection (IP)	IP20
Enclosure material	Epoxy resin
Width, inches	3.9 in
Length	156 mm
Length in inches	6.14 in
Mounting depth	117 mm
Mounting depth in inches	4.61 in
Weight	1.8 kg
Weight	3.97 lb

8562/54-4040-250 Art. No. 215088

Technical Drawings – Subject to Alterations

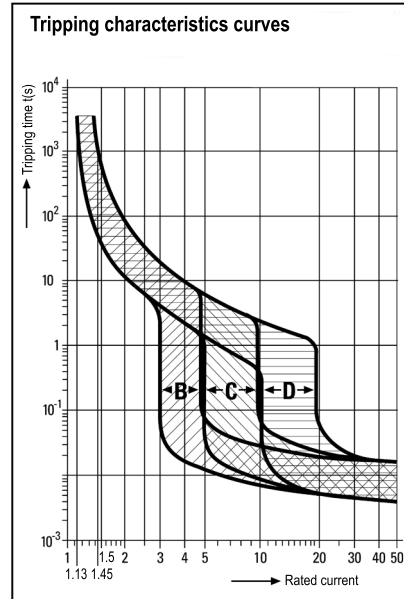
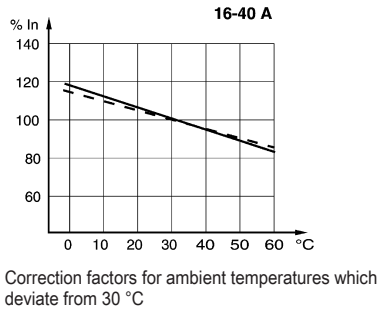
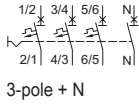

Dimensional Drawings (All Dimensions in mm [inches]) – Subject to Alterations

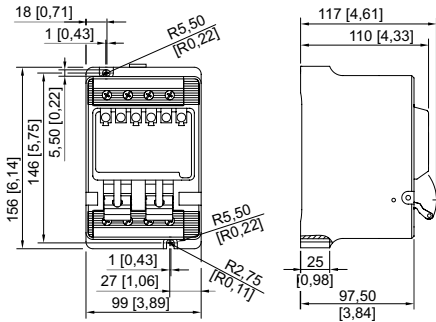

8562/54

We reserve the right to make alterations to the technical data, dimensions, weights, designs and products available without notice. The illustrations cannot be considered binding.