

Components for system solutions

Residual current Miniature circuit breaker

Miniature circuit breaker

8562/54-2376-060 Art. No. 215705



- Residual current monitoring and tripping in the event of over-voltage
- Combination of residual current circuit breaker and miniature circuit breaker: Saves space, reduces installation requirements
- Good current limiting in the event of a short circuit

MY R. STAHL 8562C



The R. STAHL Series 8562 residual current circuit breaker with overcurrent release is a residual current circuit breaker and 2-pole switching miniature circuit breaker in one: It measures residual currents and triggers in the event of overvoltage, thereby protecting the conductors in your systems from overload, earth faults and short circuits. Its excellent current limiting feature reduces the load on the conductor in the event of a short circuit.

Technical Data

Explosion Protection

Application range (zones)	1, 2
IECEx gas explosion protection	Ex de IIC T6 Gb
IECEx firedamp protection	Ex de I Mb
ATEX gas explosion protection	Ⓔ II 2 G Ex de IIC T6 Gb
ATEX firedamp protection	Ⓔ I M2 Ex de I Mb
cCSA certificate	1850696
Certificates	ATEX (PTB), China (CQST), IECEx (PTB)

Electrical Data

Type of voltage	AC
AC rated operational voltage	133 ... 230 V
Rated operational current	6 A
Rated operational current	6 A (T6)
Rated switching capacity	10 kA
Rated residual current	0.1 A
Auxiliary contacts	2 change-over contacts
Auxiliary contacts 2	1 normal 1 error signal
No. of poles	2
N-pole present	No
Tripping characteristic	B

Mechanical Data

Degree of protection (IP)	IP20
Enclosure material	Epoxy resin
Width, inches	3.9 in
Length	156 mm
Length in inches	6.14 in

Components for system solutions

Residual current Miniature circuit breaker

Miniature circuit breaker

8562/54-2376-060 Art. No. 215705



Mechanical Data

Mounting depth	125 mm
Mounting depth in inches	4.92 in
Weight	1.8 kg
Weight	3.97 lb

Technical Drawings – Subject to Alterations



Auxiliary contact 1 change-over contact
 Fault signal contact 1 change-over contact

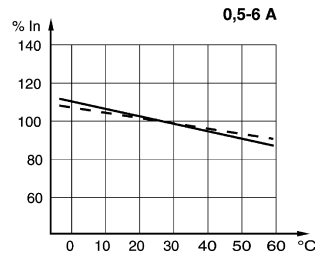

Correction factors for ambient temperatures which deviate from 30 °C

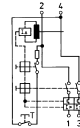

2-pole

Dimensional Drawings (All Dimensions in mm [inches]) – Subject to Alterations

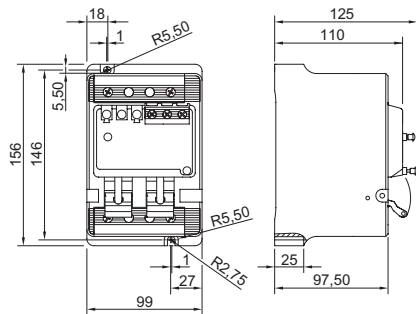

8562/54-2376-060, 2-pole with auxiliary contact and reset function

We reserve the right to make alterations to the technical data, dimensions, weights, designs and products available without notice. The illustrations cannot be considered binding.